

Operating Manual

RISH INSU 5Dt

5 kV Digital Insulation Tester



TABLE OF CONTENTS

Chapter 1: General Aspects	3
1.1 Features of the meter.....	3
Chapter 2: User and Battery Safety	5
Chapter 3: Basic Components and Indications in the Meter	7
3.1 Legends and their meanings	8
3.2 Basic indications and their meanings.....	8
Chapter 4: Connections of test leads to meter	9
Chapter 5: Measurement modes of the meter	11
5.1 IR Mode.....	11
5.2 DAR Mode.....	13
5.3 PI Mode.....	16
5.4 Step Mode.....	19
5.5 Ramp Mode.....	23
5.6 Voltage Mode.....	26
Chapter 6: Graph window	28
Chapter 7: File explorer	31
Chapter 8: Audio read-out Feature	33
Chapter 9: Settings of the meter	34
9.1 SLEEP Mode Settings.....	34
9.2 Time/date Settings.....	35
9.3 Customer information.....	36
9.4 Brightness settings.....	37

9.5 Short circuit Settings.....	38
9.6 Go No Go Settings.....	39
9.7 Other Settings(Bluetooth,USB and audio read out(speaker)).....	40
Chapter 10: Meter Specifications.....	42
Chapter 11: Battery Charging and Battery Alarms.....	45
11.1 Battery Charging Process.....	45
11.2 Battery Alarms.....	45
Chapter 12: Insulation Resistance Measurement for various Equipments.....	46
12.1 Transformers.....	46
12.2 Circuit breakers.....	47
12.3 Cables.....	47
12.4 Current transformers.....	48
12.5 Motors.....	48
Chapter 13: Connection of meter with PC using USB.....	49
Chapter 14: Connection of meter with PC using bluetooth.....	51
Chapter 15: Connection of meter with Android phone using bluetooth.....	55

CHAPTER 1

GENERAL ASPECTS

1.1 Features of the meter

- **Selectable Test Voltage up to 5000 V:** Test voltages can be set to any desired value from 100V to 5000V with steps of 10V upto 1000V and steps of 25V above 1000V.
- **High Insulation resistance measurement:** Insulation resistance measurement from 50k Ω to 2T Ω .
- **Noise rejection - 3mA:** High Noise immunity allows accurate measurement under noisy environment.
- **Polarization Index:** Polarization index (PI) testing is an extension of the insulation resistance test and is designed to check specific issues such as moisture and insulation deterioration.
- **Dielectric Absorption Ratio:** DAR measurement is a diagnostic test similar to the Polarization Index (PI), but DAR takes the ratio of the Insulation Resistance usually measured at 30 sec and 1 min.
- **Step Voltage Test:** Step Voltage Test is designed as a controlled over-voltage or proof test to provide an additional evaluation of the insulation system integrity.
- **Ramp Diagnostic Test:** The Ramp Test is performed with a slowly rising voltage.
- **Software Selectable Filter:** User selectable software filter can be used depending on noise levels. This help in accurate reading in noisy environments.
- **Capacitance Measurement:** Capacitance can be measured from 1nf to 50uF.
- **Go- NoGo Function:** User can set an insulation resistance limit below which user will be alarmed about the quality of insulation.

- **Insulation Graph Display:** Insulation Resistance trend can be displayed over the time in graphical form.
- **Communication Interface:** Bluetooth 2.0 & 4.0 Class II and electrically isolated USB 2.0 communication.
- **Software and Mobile Application:** It has data logging and monitoring software for window system and an interactive mobile application for android.
- **File Explorer:** It has file explorer to view the datalog file on TFT display.
- **Audio Read-Out:** Audible test result on completion of test for awkward locations.
- **Rechargeable Battery:** Li-Ion 3 Cell Battery with charging current of 1A.
- **Internal Data logging:** It has internal data logging feature. It can log up to 2000 test files with customer information and time stamp.
- **Selectable test time:** User can set the test time to any desired test time from 45 sec to 99 min 59 sec.

The home screen of the meter is as shown below:

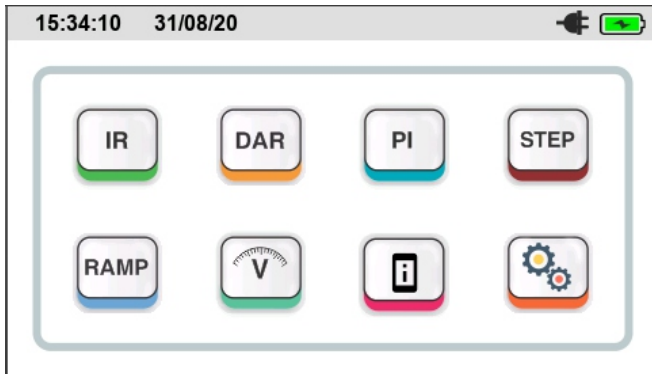

CHAPTER 2 USER AND BATTERY SAFETY

USER SAFETY:



Following safety measures should be taken while using the instrument:

- The circuit under test should be turned off /denergized(dead), all its terminals should be isolated, the circuit should also be discharged and checked before the insulation is tested.
- During the test please make sure that you do not touch any of the test leads. The caution symbol on the measurement screen indicates that hazardous voltage is present at the test leads.
- After test completion you should make sure that the load is completely discharged because this charge can be dangerous.
- The voltage indicator and internal discharge should be treated like additional safety devices and not a substitute for the general practices.
- Insulation testing in wet conditions can be hazardous. It is recommended that the instrument should not be used under these circumstances.
- During control from bluetooth or USB the test can be started at any time. Please make sure the connections are proper before turning on the test.
- Please use only the leads supplied with the meter for testing the device.

NOTE: INSTRUMENT SHOULD BE OPERATED BY SUITABLY TRAINED AND COMPETENT PERSONS ONLY

BATTERY SAFETY:

Following safety measures should be followed while handling the battery:

- Do not disassemble or change the battery. This battery consists of safety and protection devices which if damaged can cause harm to the battery.
- Do not heat the battery in any way.
- Do not pierce the battery.
- Do not expose the battery to water.

- Do not subject the battery to shocks.
- Never short circuit the battery pack.
- In case the battery starts leaking, do not allow the liquid to come in contact with skin or eyes. If by mistake you make contact, wash the affected area with water and contact doctor.
- Keep the battery away from children.
- Do not expose the battery to extreme temperatures. Extreme temperature will reduce the lifetime of the lithium ion battery.

SYMBOLS ON THE INSTRUMENT:



Caution: Please refer user manual



Caution: Risk of electrical shock



Equipment complies with current EU directives



Bluetooth



Equipment protected throughout double insulation



Do not dispose in normal waste



Audio Readout



Mains connected



Universal Serial Bus(USB)

**600 V
CAT IV**

Overvoltage category IV (equipment installed at or near the origin of the electrical supply to a building) & 600V refers to the rms phase to earth voltage that instruments can withstand to the overvoltage category IV rating.













CHAPTER 3 BASIC COMPONENTS AND INDICATIONS IN THE METER



3.1 LEGENDS AND THEIR MEANING

1. Negative(-) terminal
2. Guard(G) terminal
3. Positive(+) terminal
4. LED indicating presence of mains
5. USB slot for device connection
6. Speaker
7. Protective cover
8. Resting handle
9. TFT touch screen display

3.2 BASIC INDICATIONS AND THEIR MEANING

	Mains connected		Breakdown mode		Guard fuse blown
	Battery charging		Burn mode		USB mode
	Bluetooth mode		Pre-alarm for battery charging		Danger High Voltage at leads
	Speaker mute		Speaker unmute		Current limit warning
	Battery fully charged indication				

CHAPTER 4 CONNECTION OF TEST LEADS TO METER

The meter has 3 probes guard, positive and negative. Each probe consists of 2 ends. One of these ends is the probe handle which has to be connected to the meter and the other end will depend upon the type of accessories ordered. Figure below shows the probe handle for the single probes(Guard and positive) and double probe which is connected to the negative terminal. Both the handles have a rotor for locking the probe to the meter

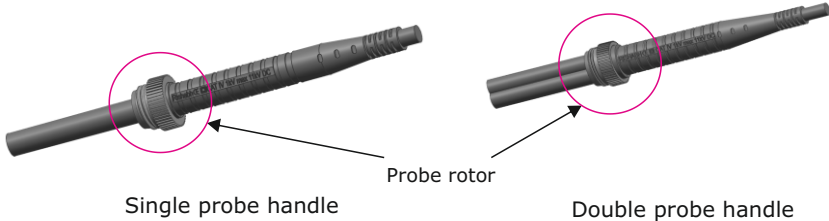

NOTE: Insulation of the DUT should be fully discharged before connecting the leads to the DUT.

Due to the locking mechanism of the probes the probes remain firmly connected to the meter during the test. Following are the steps to connect the probe to the meter:

- Insert the probes into the meter as shown in the below diagram:

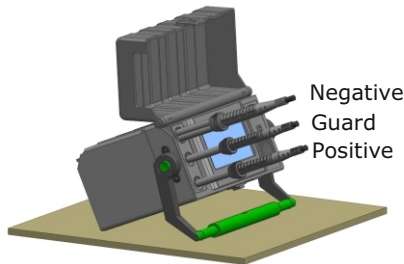

- Then push the probes into the meter and rotate the probe rotor as shown below so that the probe gets locked to the meter.

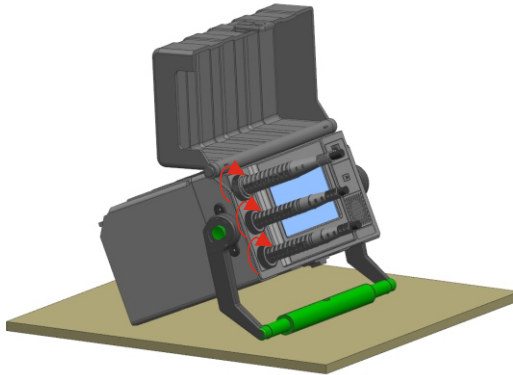

NOTE: Do not disconnect the test leads of the meter till the test has been completed and the DUT has been discharged as the leads can cause electrical hazard to the user when the test is being conducted or if the DUT is still charged.

CHAPTER 5 MEASUREMENT MODES OF THE METER

5.1 IR Mode:

This mode is used to measure the insulation resistance of a device for a fixed amount of time. The default time of this test is 45 sec. The steps to do a test in the IR mode are as follows

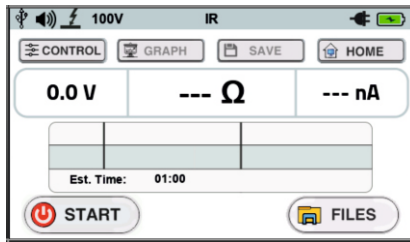

- To enter the IR mode press  icon on the home screen. The main measurement screen will appear.

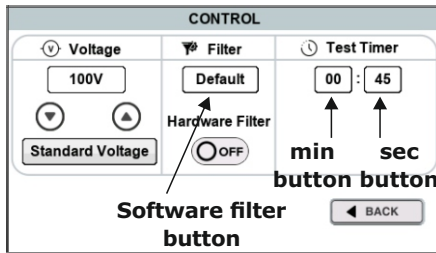

- To setup the basic settings of the mode press the  icon. The control window will appear as shown below.



- Here you can set the voltage using the voltage up and down in steps of 10V below 1000V and in steps of 25V above 1000V. There is also a standard voltage button to set standard testing voltages (100V, 250V, 500V, 1000V, 2500V, 5000V).

- You can also change the filter settings in this window (hardware and software filter). These filters are very useful in noisy environments. The software filter can be selected from the drop down list which will appear after pressing the software filter button.
- You can also set the test time in this mode by pressing the second or minute button. The keyboard will appear and then you can enter the desired time between 45 sec and 99 min 59 sec and then press the  button on the keyboard to set the time.
- After setting up all the basic settings press the  button to go back to the main measurement screen. All these control settings are stored by the meter so that the next time you start the meter you do not need to do these settings again.
- Then connect the test leads to the equipment whose Insulation Resistance has to be measured.
- On the measurement screen press and hold the  button for about 3 seconds and then release it to start the test.
- The speaker will give 3 beeps in order to indicate that the test has started. After the test has been completed all the parameters will be displayed (according to the meter setting) like insulation resistance, capacitance, DAR, PI, voltage, current as shown below.

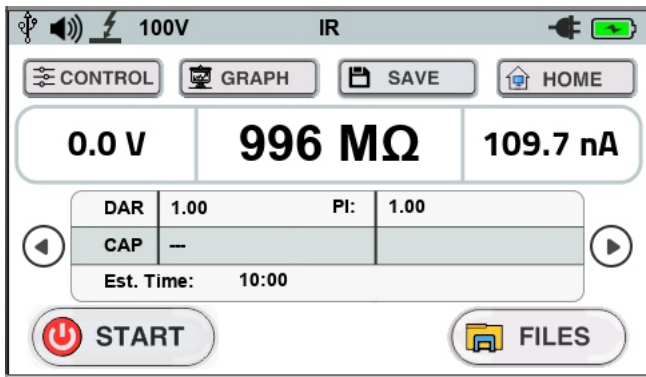

- Because there are a lot of parameters to be displayed they have been divided into three sub screens which can be scrolled using the scrolling arrows. Figure shows the sequence of the screens along with the parameters displayed on the corresponding screen.

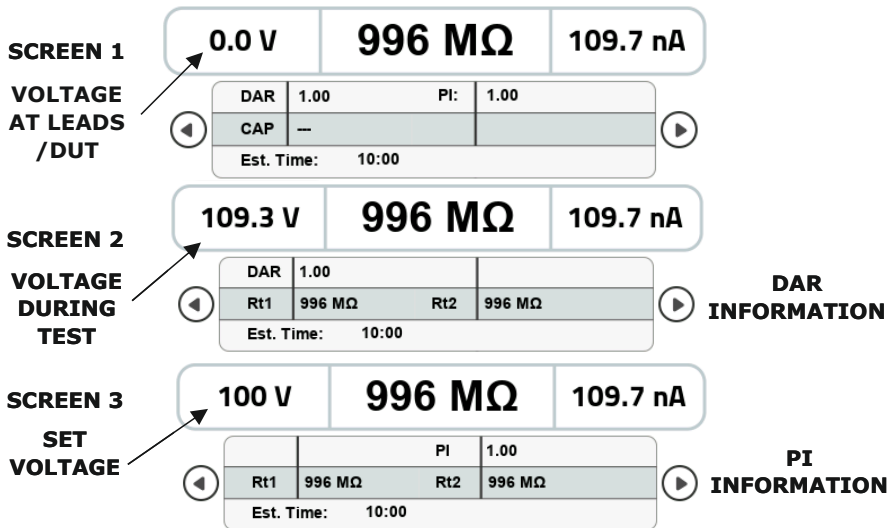

- You can save the data of this test by pressing the **SAVE** button. After pressing this button a message will appear to tell you about the file number. You can press the OK button on the message box in order to go back to the measurement screen.

5.2 DAR Mode:

DAR(Dielectric Absorption Ratio) is defined as the ratio of insulation resistance at 1 minute divided by insulation resistance at 30 seconds. It is very useful to know the condition of the insulation. It can be expressed in formula as:

DAR = IR60s / Ir30s

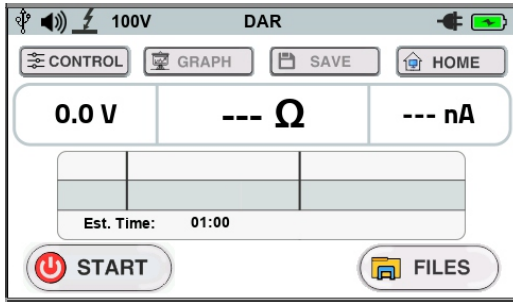

DAR of less than 1 indicates that the insulation is in poor condition, DAR of 1-1.4 indicates that the insulation is in good condition and DAR of greater than 1.4 indicates that the insulation is in an excellent condition. The steps to take a test in DAR mode are as follows:

- To enter the DAR mode press the  icon on the home screen and following screen will be displayed.

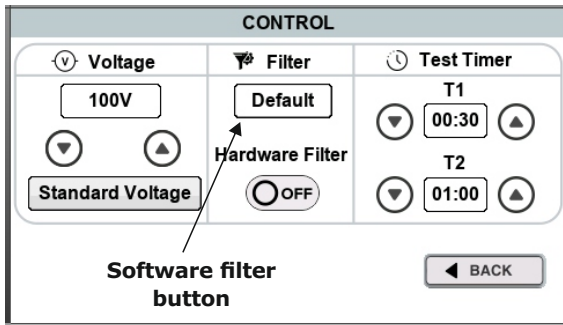

- To setup the basic settings of the mode press the  icon. The control window will appear as shown below.



- Here you can set the voltage using the voltage up and down in steps of 10V below 1000V and in steps of 25V above 1000V. There is also a standard voltage button to set standard testing voltages (100V, 250V, 500V, 1000V, 2500V, 5000V).
- You can also change the filter settings in this window (hardware and software filter). These filters are very useful in noisy environments. The software filter can be selected from the drop down list which will appear after pressing the software filter button.
- As we know DAR tests are measurements of resistance over time expressed as a ratio of resistance at time t2 divided by resistance at time t1. The t1 and t2 both can be set in the control window with the help of their corresponding arrows. The up arrow will increase the time and the down arrow will decrease the time.
- After setting up all the basic settings press the  button to go back to the main measurement screen. All these control settings are stored by the meter so that the next time you start the meter you do not need to do these settings again.
- Then connect the test leads to the equipment whose Insulation Resistance has to be measured.
- On the measurement screen press and hold the  button for about 3 seconds and then release it to start the test.
- The speaker will give 3 beeps in order to indicate that the test has started. After the test has been completed all the parameters will be displayed (according to the meter setting) like insulation resistance, capacitance, DAR, PI, voltage, current.

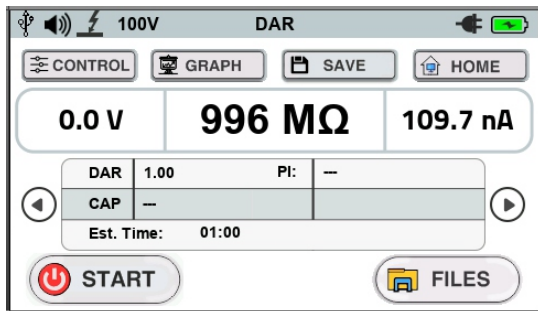

- Because there are a lot of parameters to be displayed they have been divided into three sub screens which can be scrolled using the scrolling arrows. Figure shows the sequence of the screens along with the parameters displayed on the corresponding screen.

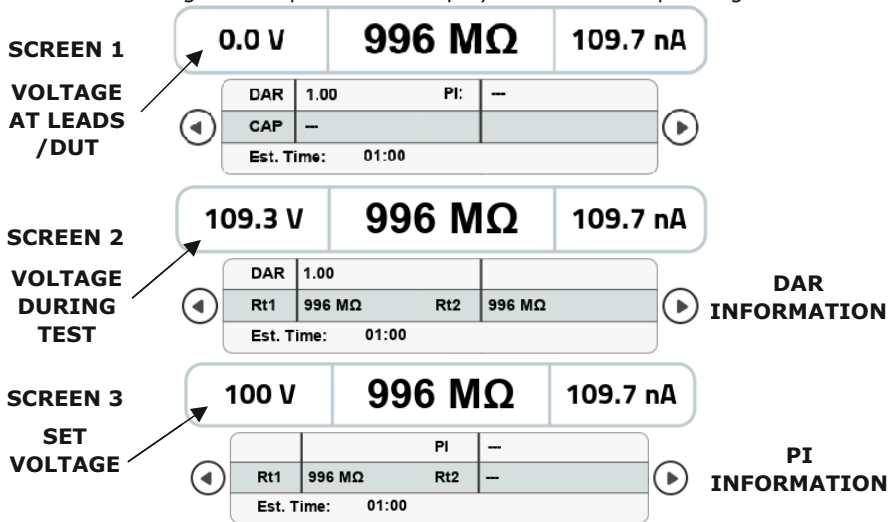

- You can save the data of this test by pressing the **SAVE** button. After pressing this button a message will appear to tell you about the file number. You can press the OK button on the message box in order to go back to the measurement screen.

5.3 PI Mode:

PI(Polarization Index) is defined as the ratio of insulation resistance at 10 minute divided by insulation resistance at 1 minute. It is very useful to know the condition of the insulation. It can be expressed in formula as:

$$PI = IR_{10min} / IR_{1min}$$

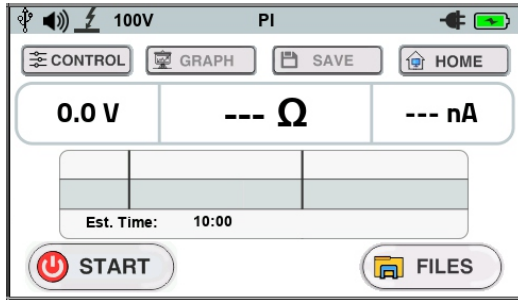

PI of less than 1-2 indicates that the insulation is in poor condition, PI of 2-4 indicates that the insulation is in good condition and DAR of greater than 4 indicates that the insulation is in an excellent condition. The steps to take a test in PI mode are as follows:

- To enter the PI mode press the  icon on the home screen and the following screen will be displayed:

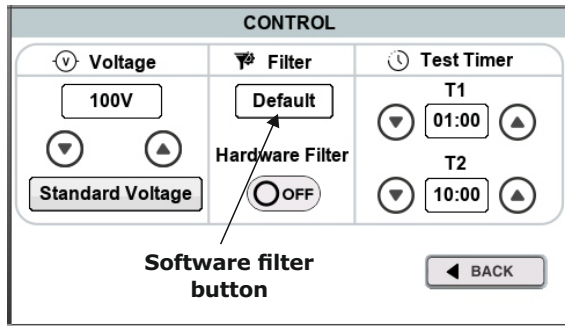

- To setup the basic settings of the mode press the  icon. The control window will appear as shown below.



- Here you can set the voltage using the voltage up and down in steps of 10V below 1000V and in steps of 25V above 1000V. There is also a standard voltage button to set standard testing voltages (100V, 250V, 500V, 1000V, 2500V, 5000V).
- You can also change the filter settings in this window (hardware and software filter). These filters are very useful in noisy environments. The software filter can be selected from the drop down list which will appear after pressing the software filter button.
- As we know PI tests are measurements of resistance over time expressed as a ratio of resistance at time t2 divided by resistance at time t1. The t1 and t2 both can be set in the control window with the help of their corresponding arrows. The up arrow will increase the time and the down arrow will decrease the time.
- After setting up all the basic settings press the  button to go back to the main measurement screen. All these control settings are stored by the meter so that the next time you start the meter you do not need to do these settings again.
- Then connect the test leads to the equipment whose Insulation Resistance has to be measured.
- On the measurement screen press and hold the  button for about 3 seconds and then release it to start the test.
- The speaker will give 3 beeps in order to indicate that the test has started. After the test has been completed all the parameters will be displayed (according to the meter setting) like insulation resistance, capacitance, DAR, PI, voltage, current.

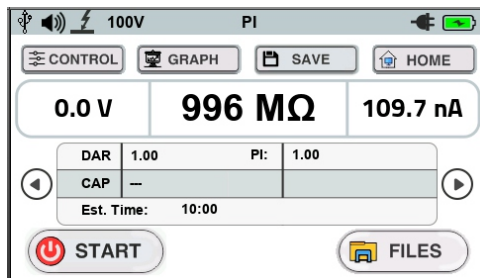

- Because there are a lot of parameters to be displayed they have been divided into three sub screens which can be scrolled using the scrolling arrows. Figure shows the sequence of the screens along with the parameters displayed on the corresponding screen.

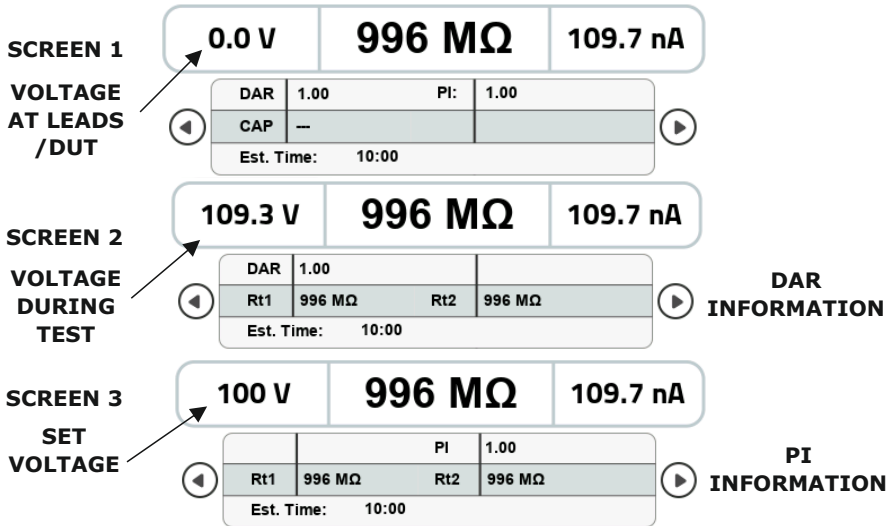

- You can save the data of this test by pressing the button. After pressing this button a message will appear to tell you about the file number. You can press the OK button on the message box in order to go back to the measurement screen.

5.4 Step Mode:

In the step voltage test 5 test voltages are applied to the DUT. The SV test is based on the principle that an ideal insulator will produce identical readings at all voltages, while an insulator which is being over stressed, will show lower insulation values at higher voltages. This test is divided into 5 intervals.

Interval = test time/5

In the first interval a test voltage of $V/5$ volts is applied to the DUT where V is the voltage selected in the control window. At the end of each interval the test voltage is increased by $V/5$ volts. So in the last interval the test voltage will become V volts. The value at the end of each interval is stored by the meter.



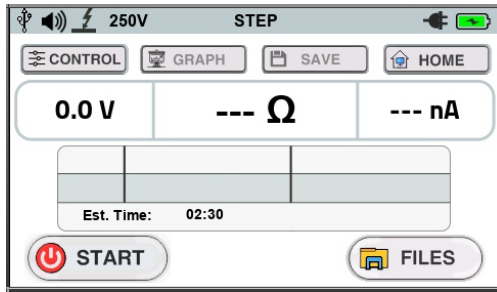

The steps to take a test in STEP mode are as follows:

- To enter the step mode press the  icon on the home screen and following screen will be displayed.

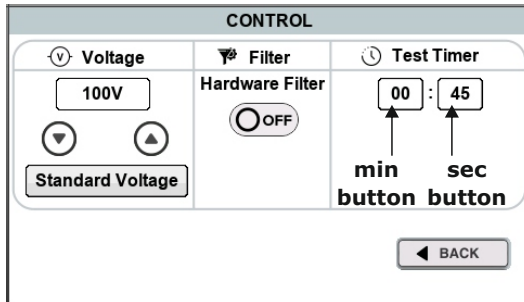

- To setup the basic settings of the mode press the  icon. The control window will appear as shown below.



- Here you can set the voltage using the voltage up and down in steps of 10V below 1000V and in steps of 25V above 1000V. There is also a standard voltage button to set standard testing voltages (250V, 500V, 1000V, 2500V, 5000V).
- You can also change the filter settings in this window (hardware filter). This filter is very useful in noisy environments.
- You can also set the test time in this mode by pressing the second or minute button. The keyboard will appear and then you can enter the desired time between 2 min 30 sec and 99 min 59 sec and then press the  button on the keyboard to set the time. Please note that the number of seconds entered should be a multiple of 5 or the meter will modify it to a value which is divisible by 5.
- After setting up all the basic settings press the  button to go back to the main measurement screen. All these control settings are stored by the meter so that the next time you start the meter you do not need to do these settings again.
- Then connect the test leads to the equipment whose Insulation Resistance has to be measured.
- On the measurement screen press and hold the  button for about 3 seconds and then release it to start the test.
- The speaker will give 3 beeps in order to indicate that the test has started. After the test has been completed all the parameters will be displayed like insulation resistance in all the 5 intervals (for last interval it is the value on the main display) and also the current and voltage values for each interval are displayed.
- Because there are a lot of parameters to be displayed they have been divided into three sub screens which can be scrolled using the scrolling arrows. Figure (on next page) shows the sequence of the screens along with the parameters displayed on the corresponding screen.
- You can save the data of this test by pressing the  button. After pressing this button a message will appear to tell you about the file number. You can press the OK button on the message box in order to go back to the measurement screen.

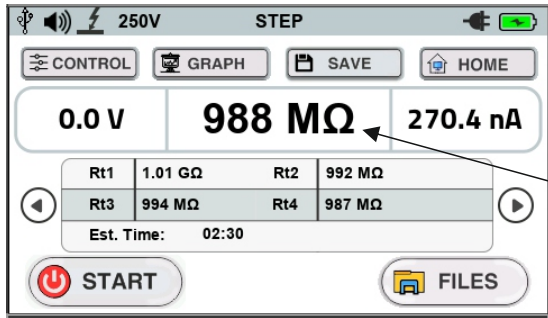

**RESISTANCE AT
LAST
INTERVAL/STEP
(Rt5)**

**SCREEN 1
VOLTAGE AT LEADS
/DUT**

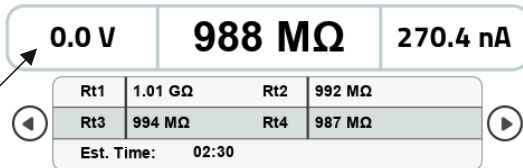

**RESISTANCE
AT EACH STEP**

**SCREEN 2
VOLTAGE DURING
TEST**

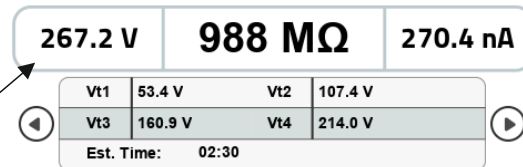

**VOLTAGE AT
EACH STEP**

**SCREEN 3
SET
VOLTAGE**

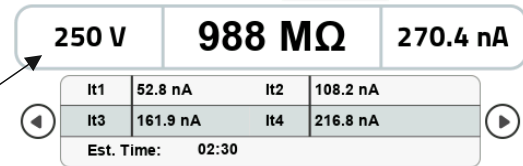

**CURRENT AT
EACH STEP**

Please note that in step mode if the meter is running on battery supply, the meter will not be able to deliver 5000V to a load resistance of below 10 MΩ.

5.5 Ramp Mode:

The ramp mode is similar to the step voltage test but with many small tests. In this test the voltage increases continuously each second. The rate of increase of voltage is determined by the slope rate which can be set in the control window. For a slope rate of 100V/min the voltage will increase by approximately 1.67V in one second. (100V in 60 sec)

The final voltage is also set by user. This is the voltage up to which the test has to be conducted (It will stop increasing if current limit condition is detected). The current limit condition is detected when current is greater than short circuit current limit which can be set in the settings window. It will be discussed in detail in the further chapters. The test time in this test is determined by the final voltage and the slope. Example if you set 100V and 100V/min slope rate the test time will become one minute.

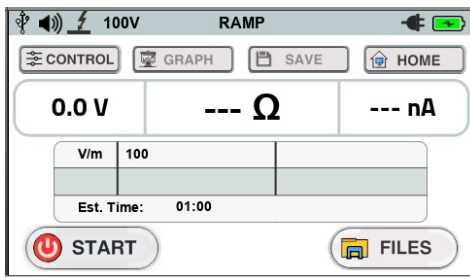

The steps to take a test in RAMP mode are as follows:

- To enter the PI mode press the  icon on the home screen and following screen will appear.

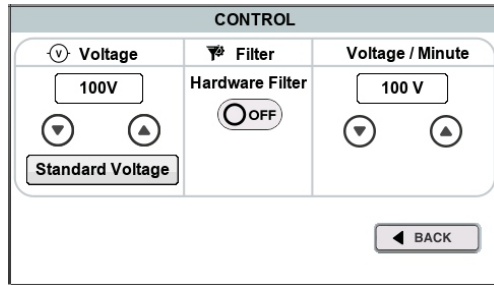

- To setup the basic settings of the mode press the  icon. The control window will appear as shown on the figure on next page.
- Here you can set the voltage using the voltage up and down in steps of 10V below 1000V and in steps of 25V above 1000V. There is also a standard voltage button to set standard testing voltages (100V, 250V, 500V, 1000V, 2500V, 5000V).



- You can also change the filter settings in this window (hardware filter). This filter is very useful in noisy environments.
- You can also set the slope rate (voltage/min) with up and down arrows in this window. It is the rate at which voltage will increase in the test. Max slope rate is 5000 V/m.
- After setting up all the basic settings press the  button to go back to the main measurement screen. All these control settings are stored by the meter so that the next time you start the meter you do not need to do these settings again.
- Then connect the test leads to the equipment whose Insulation Resistance has to be measured.
- On the measurement screen press and hold the  button for about 3 seconds and then release it to start the test.
- The speaker will give 3 beeps in order to indicate that the test has started. After the test has been completed all the parameters will be displayed like insulation resistance voltage and current.
- Because there are a lot of parameters to be displayed they have been divided into three sub screens which can be scrolled using the scrolling arrows. Figure (on next page) shows the sequence of the screens along with the parameters displayed on the corresponding screen.

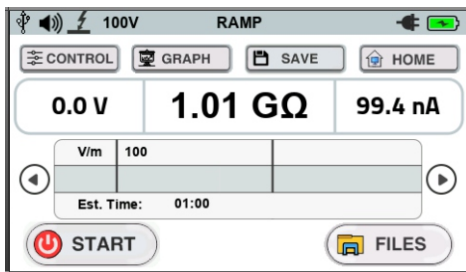

SCREEN 1
VOLTAGE
AT LEADS
/DUT

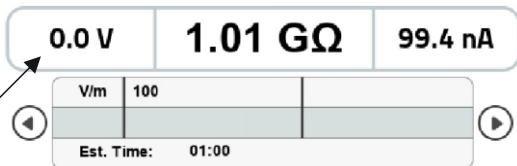

SCREEN 2
VOLTAGE
DURING
TEST

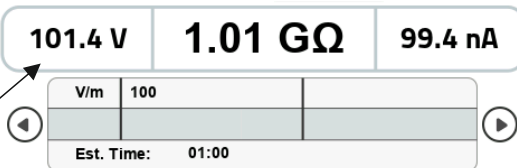

SCREEN 3
SET
VOLTAGE

SLOPE

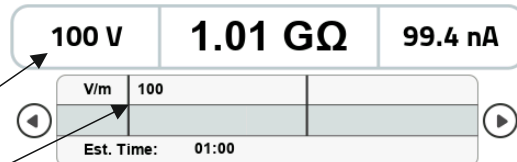

- You can save the data of this test by pressing the **SAVE** button. After pressing this button a message will appear to tell you about the file number. You can press the OK button on the message box in order to go back to the measurement screen.

Please note that if in any test the test current reaches beyond 1 mA, the meter will take a response time of about 10 min to display accurate readings for a current below 10 nA. This time can be reduced by turning hardware filter off.

Please note that the capacitance measurement is not available in the STEP and RAMP modes of measurement.

Please note that for the proper measurement of capacitance of DUT the test should be run till the voltage of DUT reaches the set voltage.

5.6 Voltage Mode:

- The instrument also has a voltmeter that measures AC/DC voltage from 20 V to 600 V. This voltmeter is useful as it shows the presence of voltage when it is connected to a DUT which has induced voltage.
- To enter the voltage mode press the  button on the home screen of the meter. The following screen will be displayed.

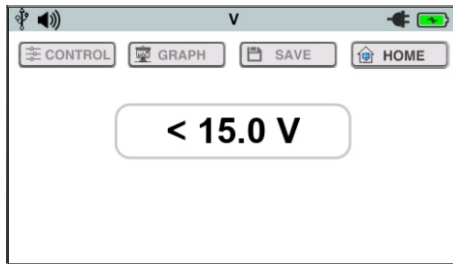

- Additionally the meter also displays the voltage at the test leads/DUT in other modes(IR,DAR,PI,STEP and RAMP) before the start of the test as shown in figure (figure on next page).

- Before the start of the test if voltage above 50V is present at the terminals the speaker will make beep sound to indicate the presence of voltage in these modes(IR,DAR,PI,STEP and RAMP).

VOLTAGE AT LEADS/DUT

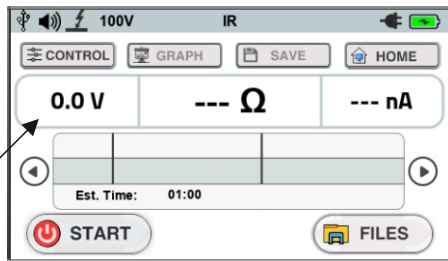

CHAPTER 6 GRAPH WINDOW

Along with the insulation resistance value and related parameters the meter also shows a trend of the insulation resistance of the DUT over time. This is a very important feature as the trend of the insulation resistance gives a lot of information about the condition of the insulation. In the graph there can be a maximum of 300 data points. The interval between each data point depends upon the test duration. Table shows the test duration and the corresponding interval between each data point.

Test duration	Duration between 2 data points(Sample rate)
<=5min	1 sec/data point
5 min 01 sec - 10 min	2 sec/data point
10 min 01 sec - 15 min	3 sec/data point
15 min 01 sec - 20 min	4 sec/data point
20 min 01 sec - 25 min	5 sec/data point
25 min 01 sec - 30 min	6 sec/data point
30 min 01 sec - 35 min	7 sec/data point
35 min 01 sec - 40 min	8 sec/data point
40 min 01 sec - 45 min	9 sec/data point
45 min 01 sec - 50 min	10 sec/data point
50 min 01 sec - 55 min	11 sec/data point
55 min 01 sec - 60 min	12 sec/data point
60 min 01 sec - 65 min	13 sec/data point
65 min 01 sec - 70 min	14 sec/data point
70 min 01 sec - 75 min	15 sec/data point
75 min 01 sec - 80 min	16 sec/data point
80 min 01 sec - 85 min	17 sec/data point

Test duration	Duration between 2 data points(Sample rate)
80 min 01 sec - 85 min	17 sec/data point
85 min 01 sec - 90 min	18 sec/data point
90 min 01 sec - 95 min	19 sec/data point
95 min 01 sec - 99 min 59 sec	20 sec/data point

Following are the steps to view graph of insulation resistance vs time for a given DUT:

- On the home screen go to your desired test mode(IR,DAR,PI,STEP or RAMP) using their corresponding button.
- After this run the test as per the instructions given in the previous chapter.
- After the test is completed, press the **GRAPH** button to display the graph window. The graph window is as shown below:

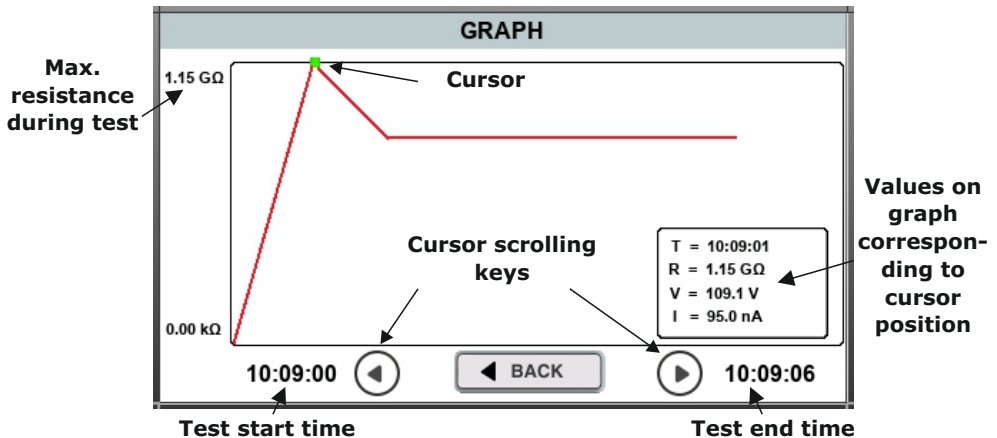

- With the help of arrow keys on the graph window you can view the detailed information of each data point (time, voltage, current and insulation resistance). To indicate the point on the graph the cursor also moves on the graph.
- To exit the graph window you can press the button.
- Along with the data of the test the graph of the test is also stored when you save the file. The saved graph can be viewed in the file explorer.
- Also you can view the graph while the test is running. While the test is running the detailed information of each point and cursor cannot be viewed. The graph window while the test is running will be as shown below. The values displayed in the box are realtime value of the parameters.

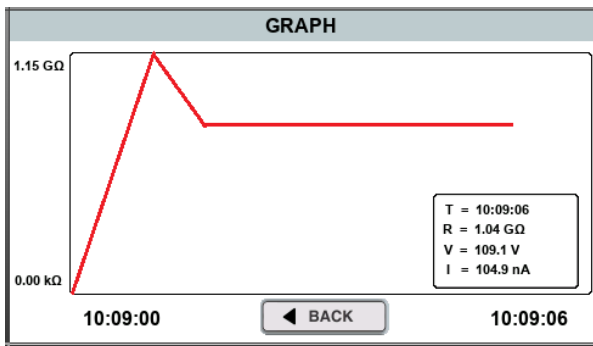

CHAPTER 7 FILE EXPLORER

The meter has an inbuilt storage facility where we can save the test data for future analysis. The meter has storage capacity of 2000 files. Along with the parameters (insulation resistance, voltage, current, DAR, PI and many others) the device also stores the graph for the saved test. It is also possible to delete unwanted files from the meter. To enter the file explorer and to read the data in your desired files you have to follow the following steps:

- On the home screen enter any mode using their respective icon.(IR,DAR,PI,STEP or RAMP)
- Press the  button to enter the file explorer. The file explorer window will appear as shown:

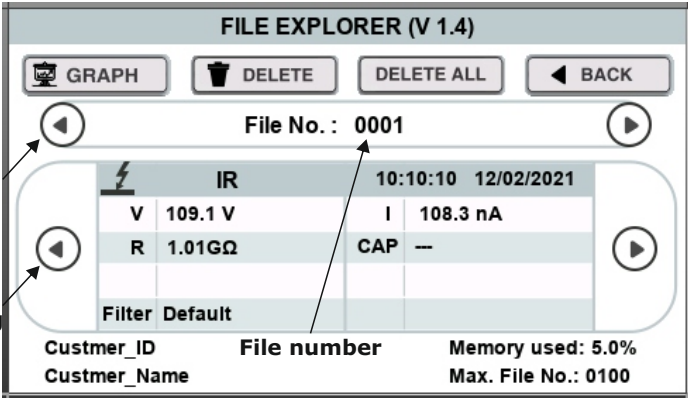

FILE EXPLORER (V 1.4)

GRAPH DELETE DELETE ALL BACK

File No. : 0001





IR	10:10:10	12/02/2021
V 109.1 V	I 108.3 nA	
R 1.01GΩ	CAP --	
Filter Default		

Customer_ID File number Memory used: 5.0%
Customer_Name Max. File No.: 0100

File scrolling arrow

Data scrolling arrow

- When you open the file explorer it displays the last file saved by the user. To go to your desired file click on the file number.
- Enter the file number on keyboard and then press  button and the file will appear.

- You can also scroll to the desired file using the arrow keys.
- In some modes there are a lot of parameters which cannot be displayed on a single screen. So in such cases the main parameters are displayed on the front. The other parameters can be seen by pressing the scrolling arrows.
- You can also view the graph for the test by pressing the  button.
- In case the memory gets fully occupied you can delete individual files by going to the file and pressing the  button.
- You can also delete all the files by pressing the  button.
- You can go back to the main screen by using the  button.
- The file explorer also stores the customer information which can be set in the settings window in order to differentiate a test from other tests.

CHAPTER 8 AUDIO READ-OUT FEATURE

The meter has the audio read out feature. The meter reads out the insulation resistance values and other parameters like Polarization index(PI) and Dielectric Absorption Ratio(DAR) with the help of powerful speaker. This feature comes in very handy where the screen of meter is not directly accessible.

Depending upon the mode of the meter it will announce values accordingly. In the IR, STEP and RAMP modes the meter will read out the resistance after the test has been completed. In the PI mode it will read out the Polarization Index(PI) and in the DAR mode it will read out the Dielectric Absorption Ratio(DAR) after the test is completed.



This feature can be turned on/off by the user. So to check whether this feature is on/off you can look at the mute/unmute icon in the status bar as shown below:



 indicates that the audio read-out feature is ON.

 indicates that the audio read-out feature is OFF.

To turn this setting ON/OFF:

- Click on the  icon on the home screen to enter the settings menu.
- Then click on the  icon on the settings screen to enter the other settings window.
- Then click on the mute/unmute icon to turn this setting on/off.

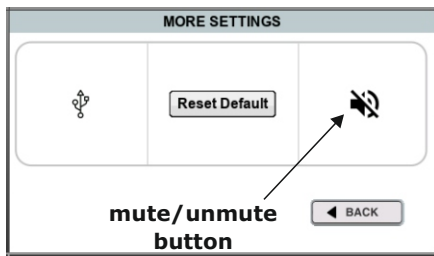

CHAPTER 9 SETTINGS OF THE METER

In addition to the settings in the control settings, there are also additional settings provided in the meter. These settings include sleep, date and time, customer information, brightness, short circuit, go no go and other settings. To enter the settings window press the  icon to enter the settings window. Please note that all the settings in this window (except date/time, mute/unmute and bluetooth/usb) get reset to their default values once the meter is restarted. The settings window is as shown below:

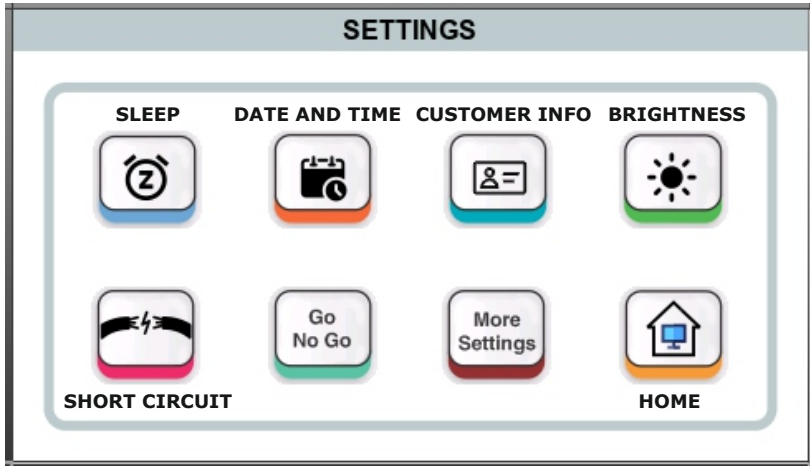

9.1 SLEEP Mode Settings:

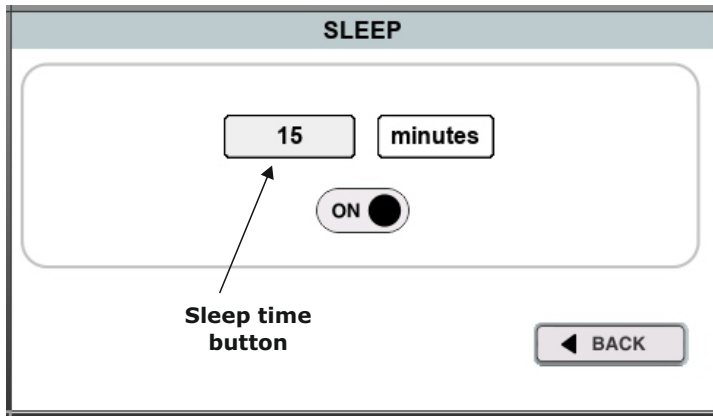

As the meter is a battery operated device power saving plays a very important role. So we have added 'sleep mode' in the meter to save power. In this mode the back light of the TFT LCD and communication is turned off in order to reduce the power consumption of the battery. Therefore the meter will operate for a longer time. Please note that the meter is not

turned off in this mode. You will enter the sleep mode after a specified minutes of inactivity which can be set (default: 15 min). Also the sleep mode can be turned off if required by the user. Once meter enters the sleep mode you can come out of sleep mode by touching the screen. The sleep mode settings can be changed by pressing the  icon in the settings window and the following screen will appear.



Here you can change the sleep time by pressing on the minutes button and a keyboard will appear where you have to enter the minutes and press  button. The sleep mode can also be turned ON/OFF by clicking on the ON/OFF button.

9.2 Time/Date Settings:

As we know the meter can save the test data with its corresponding time. The meter's date and time can be changed by pressing the  icon on the settings window. The hour, minute, second, day, month and year can be changed by clicking on their respective buttons after which keyboard appears and then you can enter the desired value and press .

The date and time window is as shown below:

DATE AND TIME

00 : 00 : 00 01 / 01 / 00
hh mm ss DD MM YY

Click on the corresponding button to change field

◀ BACK

9.3 Customer Information Settings:

Along with the parameters the meter also stores customer information in the file in which the customer can write the test specific data like customer ID and name. This can also be set in the setting window by pressing the  button after which the following window appears:

CUSTOMER INFORMATION

ID (maximum 10 characters)

Name (maximum 20 characters)

Customer ID button Customer Name button

◀ BACK

In this window you can edit the customer ID and name by clicking on their respective buttons. Then an alphanumeric keyboard will appear where you have to enter the customer ID/ name and then press the **ENTER** key.

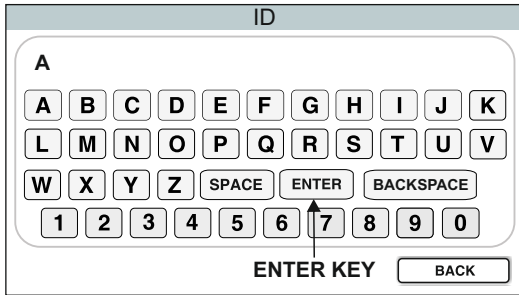

9.4 Brightness Settings:

You can also change the brightness of the screen as per your requirement. There are three settings available. You can change the brightness settings by pressing the  icon in the settings window. It is a very useful aid for battery saving.

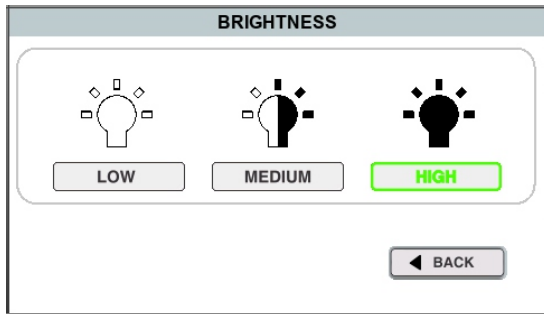

9.5 Short Circuit Settings:

In this meter the short circuit current of the meter can also be changed. There are 2 settings available 1.2 mA and 3 mA. Also in case of fault(current goes above short circuit value) you can select whether to keep running the test or not using the breakdown/burn settings. To change these settings you can press the  icon and then the following window will be displayed:

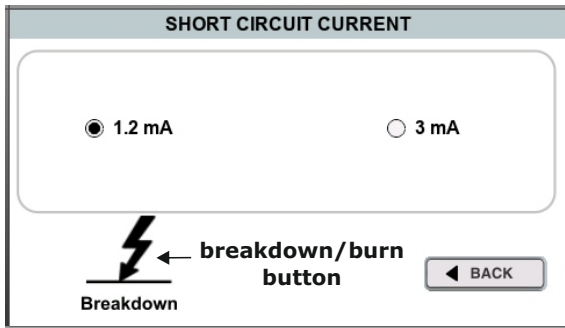

You can select the desired short circuit current by clicking on the corresponding button. And you can change the breakdown/burn setting by clicking on the icon in the bottom left corner which indicates the present breakdown/burn setting.

Difference between breakdown mode and burn mode:

Breakdown mode: In this mode the insulation resistance test will be stopped in case the current in the DUT crosses the selected short circuit current for about 20 seconds. In breakdown mode the meter displays message. The meter may display one of 2 different messages after it stops:

- **Current limit condition detected:** This is displayed if the voltage at DUT delivered by meter doesn't reach the nominal voltage(voltage set by user) and the current crosses the short circuit current for about 20 sec.

- **Breakdown condition detected:** This is displayed if the voltage at DUT delivered by meter reaches the nominal voltage(voltage set by user) and the current crosses the short circuit current for about 20 sec. This message will not be displayed in the RAMP mode, only current limit condition is shown in this mode even if breakdown condition occurs.

Burn mode: In this mode the insulation resistance test is not stopped even if the current in the DUT crosses the short circuit current. In this case the meter limits the current in the DUT to the short circuit current so that harm is not caused due to excessive current.

In addition to the above messages another message maybe displayed which is “High voltage shorted to guard or breakdown”. This is displayed when the voltage doesn’t reach the desired value and the current is below 1 mA. This is generally displayed when the user accidentally shorts the positive and guard terminals/guard breakdown. Please note that this message will be shown in both BURN mode and BREAKDOWN mode.

9.6 Go No Go Settings:

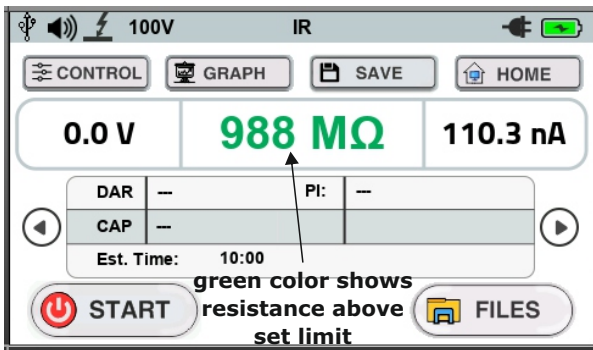

This meter also has go no go setting in which a user can set a limit above which the insulation will be declared healthy by the meter. During the test the insulation resistance text color will turn green on the main measurement screen if the go no go setting is ON and the insulation resistance is above the decided limit as shown below otherwise it will turn red.

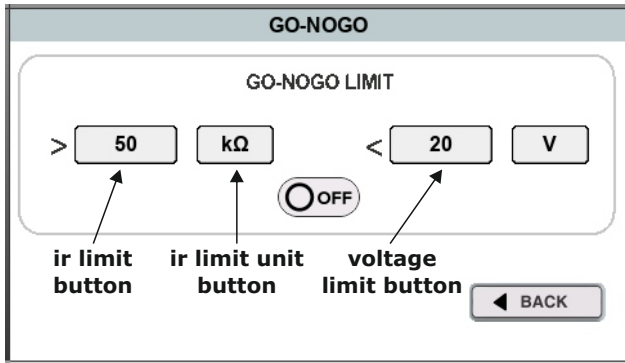

The go no go setting is also available in the voltage mode where the voltage text color will turn red if the go no go setting is ON and the voltage is above the decided limit

otherwise it will turn green. The go no go settings can be changed by pressing the  icon on the settings window.



You can change the go no go insulation resistance limit by clicking on the go no go insulation resistance button after which a keyboard will appear where you can insert the desired value and press the  button. The unit of the insulation resistance can be changed by pressing the go no go resistance unit button. Similarly you can also change the go no go voltage limit by pressing on the go no go voltage button and entering the desired value on the keyboard and then pressing the  button. You can also turn on/off go no go by clicking on/off button shown in the above window. The icon of this button shows whether the go no go function is on/off.

9.7 Other Settings:

Apart from all the above settings there are also a few more additional settings. These include the Communication interface setting, Audio on/off feature, and the reset default settings button which will reset control settings, and the other settings in the settings menu to their default value. To change these settings in the settings window, press the 

the  icon. Then the more settings window will be displayed as shown on the next page.

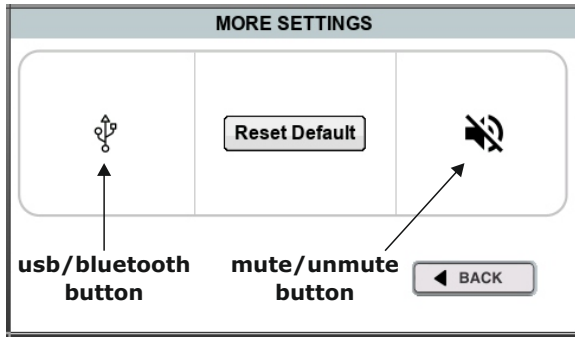

Communication interface setting: This meter has 2 interfaces for communication (Bluetooth or USB). Please note that at any given time only one interface can be used for communication. To select which interface to use you can press the USB/bluetooth button in the more settings window. The currently activated interface is shown by the icon of this button.

Audio read out setting: As discussed before, this meter also has the audio read out feature. The meter reads out the insulation resistance values and other parameters like Polarization index(PI) and Dielectric Absorption Ratio(DAR) with the help of powerful speaker. This feature can be turned on/off by pressing the mute/unmute button. Please note that even if the speaker is muted the meter will give cautionary beeps at the start of the test. This feature comes in very handy where the screen of meter is not directly accessible.

Reset default settings: The meter settings(control settings and settings in the setting window) can be set to their default value using the reset default button in the more settings window.

CHAPTER 10 METER SPECIFICATIONS

- **Insulation Resistance Measurement:**

Nominal voltage	Maximum Resistance	Intrinsic Error
100 V	2 GΩ	5% ± 1D
250 V	10 GΩ	5% ± 1D
	100 GΩ	20% ± 1D
500 V	20 GΩ	5% ± 1D
	200 GΩ	20% ± 1D
1000 V	40 GΩ	5% ± 1D
	500 GΩ	20% ± 1D
2500 V	100 GΩ	5% ± 1D
	1 TΩ	20% ± 1D
5000 V	200 GΩ	5% ± 1D
	2 TΩ	20% ± 1D

- **Voltage Measurement:**

Measuring Range	Frequency	Intrinsic Error
20V - 600V AC DC	45 Hz- 500 Hz	3% + 10D

- **Capacitance Measurement:** 1nF to 50uF; Accuracy $\pm 10\% \pm 5$ digits
- **Insulation Leakage Current Measurement:** 0.01nA to 3mA; Accuracy $\pm 5\% \pm 0.2$ nA
- **Test voltage Accuracy:** +7%, -0%, ± 10 V nominal test voltage

- **Guard terminal:** 2% error guarding 500 kΩ leakage, 100 MΩ load

- **Timer range for IR tests:**

Time: 45s - 99 min 59 sec with three programmable timers

Tests: IR(t),DAR,PI,Step Voltage, Ramp voltage

- **Ambient conditions:**

Operating Temperature: -20°C - +50°C

Storage Temperature: -20°C - +70°C

Relative Humidity: max. 90% (condensation must be avoided)

Elevation: up to 2000m

Protection: IP 52

- **Applicable Standards:**

Standard	Norms
IEC 61010-1	Safety regulations for electrical measurement, control, regulation and lab devices
IEC 61557	Measuring and monitoring facilities for testing the electrical safety in lines with nominal voltages up to AC1000V and DC1500V
PART-1	General
PART-2	Insulation resistance measuring devices

- **Reference Conditions:**

Ambient Temperature: 23°C \pm 2 k

Relative Humidity: 45-55%

Measured quantity frequency: 50 Hz \pm 10 Hz

Line voltage waveform: Sine wave

Battery Voltage: 11.1V \pm 1%

Operating position: Horizontal

Power Supply Voltage(Mains): 230V \pm 15% 50/60 Hz

- **Battery specifications:**

Battery: 11.1 V, 7.8Ah Li-on battery

Battery Service Life: 6 Hrs continuous testing at 5 KV (100 Megaohm load)

Battery charging time: 7 Hrs

- **Power Supply (Mains):** Nominal power(mains) 230V AC \pm 15%, 50/60 Hz

- **Power Supply Fuse Rating:** Dimension(20X5mm), 250VAC , 5A

- **Electromagnetic Compatibility Standard:** IEC 61326-1

- **Immunity:**

IEC 61000-4-2: 8 KV atmosphere discharge, 4 KV contact discharge

IEC 61000-4-3: 3 V/m

- **Electrical Safety:**

Over voltage category: 600 V CAT IV

Test voltage: 7.4 KV AC

Pollution degree: 2

- **Dimensions:**

L X B X H: 290mm x 250mm x 140mm

Weight: Approx. 5 kg

- **Accessories:**

- a) Standard scope of supply:**

1 In built Li-ion rechargeable battery

1 Operating instructions

1 Power cord

1 USB cable for communication and software CD

- b) Test lead options(whichever applicable):**

Test lead set with 3m test leads with crocodile clips (+ve, -ve & Guard lead)

Test lead set with 3m test leads(+ve, -ve & Guard lead)with 3 clamps(50 mm jaw opening)

Test lead set with 10m test leads(+ve, -ve & Guard lead)with 3 clamps(50 mm jaw opening)

Test lead set with 15m test leads(+ve, -ve & Guard lead)with 3 clamps(50 mm jaw opening)

CHAPTER 11

BATTERY CHARGING AND BATTERY ALARMS

11.1 Battery charging process:

- To charge the battery of the meter you have to insert the power cord provided with the meter into the socket at the back of the meter.
- Then connect the power cord into any nearby power socket. Please make sure that the voltage supplied to the power cord is according to the specifications provided in the manual or datasheet(230 V \pm 15% 50/60 Hz AC supply).
- Then turn on the switch of the socket and the mains power LED will turn ON to indicate the presence of mains.
- Also the power cord symbol will appear on the task bar as shown below. Also the battery charging symbol will appear.

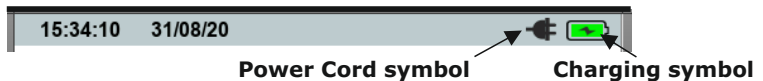

- If the meter battery has completely discharged it will take about 7 Hrs to charge the battery. As soon as the battery gets charged the charging symbol will disappear in the status bar as shown below.



- Please note that even if the meter is turned off the battery will charge if power cord is connected.

11.2 Battery alarms:

- The battery pre-alarm indication appears when the battery level is approximately below 50% and it does not affect the measurement.



- When the battery level is extremely low a message box is displayed with warning "Battery low..! Test will not start." and this means measurement is not possible.

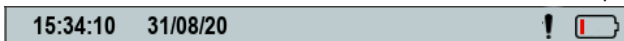

CHAPTER 12

INSULATION RESISTANCE MEASUREMENT FOR VARIOUS EQUIPMENTS

Insulation resistance is measured while manufacturing various equipments like transformer, circuit breakers, cables etc. It should be noted that the negative measurement lead should not be connected to large ground conductors. Following are the connections schemes for insulation resistance measurement for different equipments:

12.1 TRANSFORMERS:

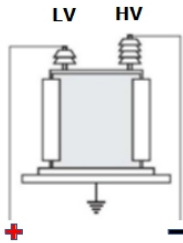

HV winding (with 3 phases short) to LV winding (with 3 phases short)

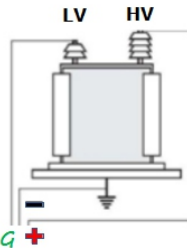

HV winding (with 3 phases short) to ground with LV winding guarded

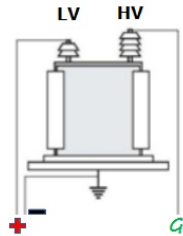

LV winding (with 3 phases short) to ground with HV winding guarded

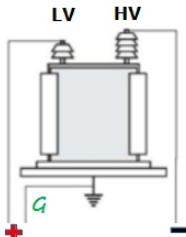

HV winding (with 3 phases short) to LV winding (with 3 phases short)

- + Positive terminal of insulation tester
- Negative terminal of insulation tester
- G Guard terminal of insulation tester

12.2 CIRCUIT BREAKERS:

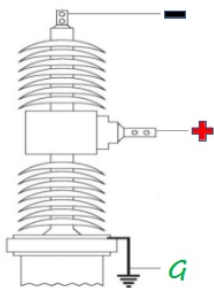

Top to bottom with guard grounded

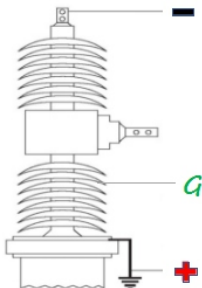

Top to earth with guard to body

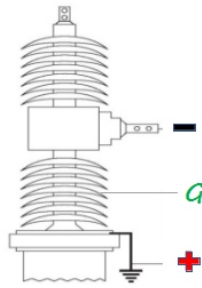

Bottom to earth with guard to body

+ Positive terminal of insulation tester **■** Negative terminal of insulation tester

G Guard terminal of insulation tester

12.3 CABLES:

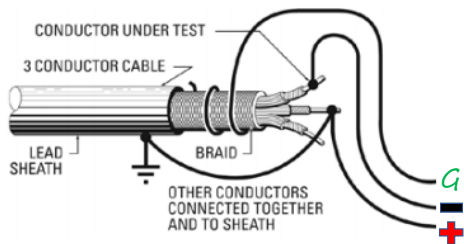

+ Positive terminal of insulation tester

■ Negative terminal of insulation tester

G Guard terminal of insulation tester

Insulation resistance of power cables

12.4 CURRENT TRANSFORMERS:

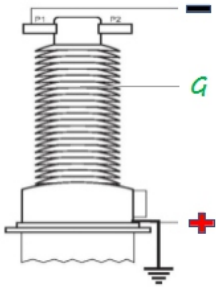

- +** Positive terminal of insulation tester
- Negative terminal of insulation tester
- G** Guard terminal of insulation tester

Primary to ground with body of the CT connected to guard

12.5 MOTORS:

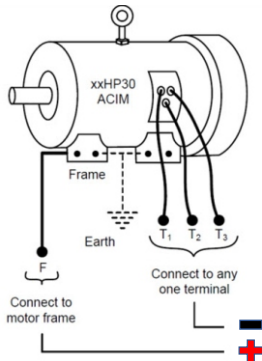

- +** Positive terminal of insulation tester
- Negative terminal of insulation tester

Insulation resistance testing of motor

CHAPTER 13

CONNECTION OF METER WITH PC USING USB

For connection of meter with the PC using USB follow the following steps:

- On the meter, go to Settings> More Settings and turn on the USB by touching on the USB/bluetooth. When the icon will have icon of USB it means USB has been selected.

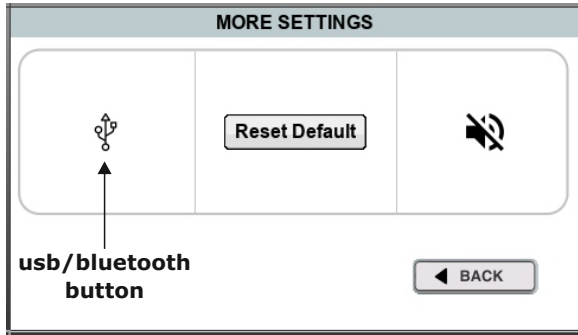

- Then go back to home screen of the meter and then connect the USB cord received with the meter to the USB port of the meter.
- Then installing driver message will appear on the computer as shown below.

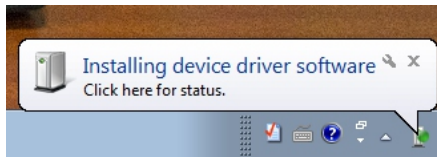

- Then driver installed message will appear as shown below.

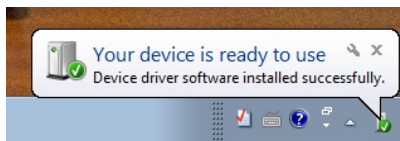

- Then go to the device manager of your computer and check the COM port of the installed device as shown below.

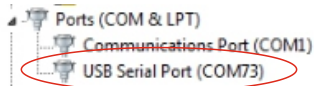

- Then install the software provided with the device.
- Then select the COM port in the software and press the connect button.

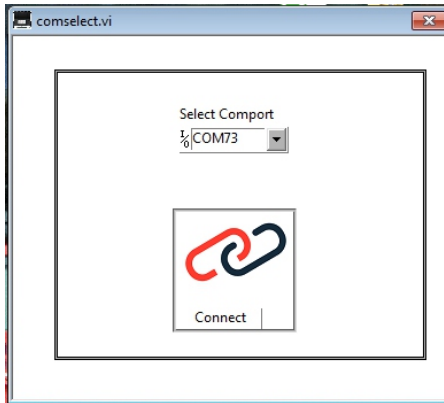

- Then message will be displayed. Press ok button as shown below and the device will be connected to the software.

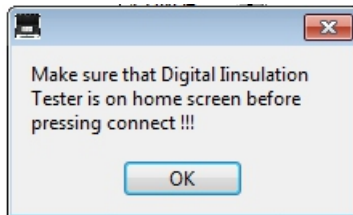

CHAPTER 14

CONNECTION OF METER WITH PC USING BLUETOOTH

For connection of meter with the PC using USB follow the following steps:

- On the meter, go to Settings> More Settings and turn on the bluetooth by touching on the USB/bluetooth. When the icon will have icon of bluetooth it means bluetooth has been selected.

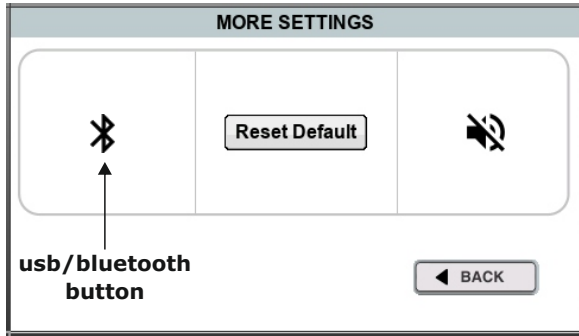

- Then go back to home screen of the meter.
- Make sure bluetooth is turned ON on your computer.
- Right click on the bluetooth icon on the taskbar.



- Then click on add new device.

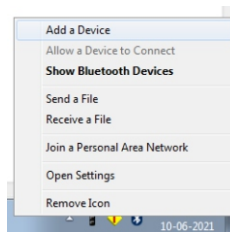

- Then click on 5Dt_xxxxxxxx where xxxxxxxx is serial number and then press next button.

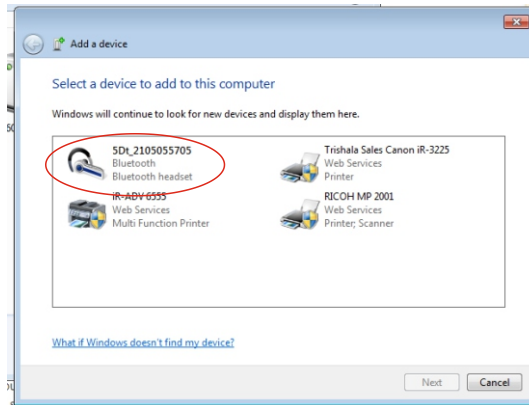

- The computer will pair with the device and the following screen will appear. Click on the close button.



- Then installing driver message will appear.

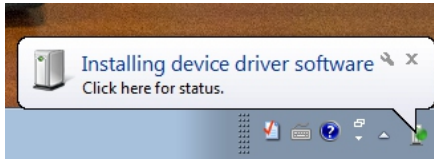

- Wait till the driver is installed and then driver installed message will appear.

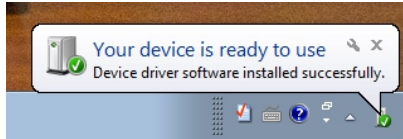

- Now again right click on the bluetooth icon and click on show bluetooth device.
- Then right click on 5Dt_xxxxxxxx and click properties.

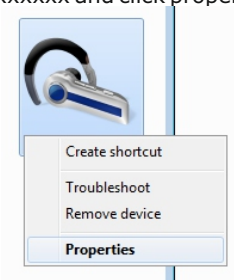

- In properties go to Hardware and note the COM port.

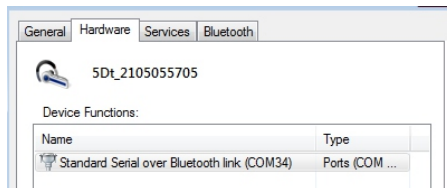

- Then install the software provided with the device.
- Then select the COM port in the software and press the connect button.

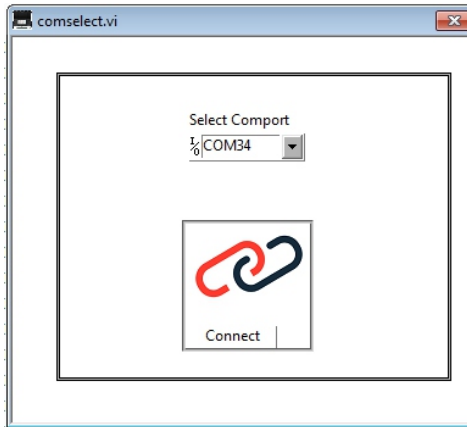

- Then press ok button as shown below and the device will be connected to the computer.

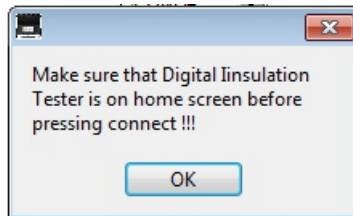

CHAPTER 15

CONNECTION OF METER WITH ANDROID PHONE USING BLUETOOTH

For connection of meter with the PC using USB follow the following steps:

- On the meter, go to Settings> More Settings and turn on the bluetooth by touching on the USB/bluetooth. When the icon will have icon of bluetooth it means bluetooth has been selected.

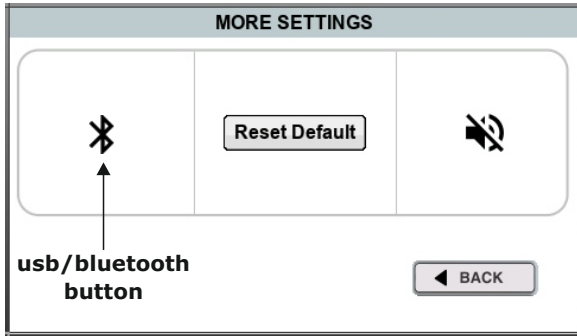

- Then go back to home screen of the meter.
- Install the mobile application (INSU Connect) on your phone from google play store.
- Then provide the permissions of bluetooth and location to the application.
- Turn on bluetooth and location on your phone and open the application.

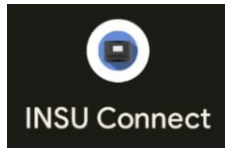

- Then press the button shown in the figure.

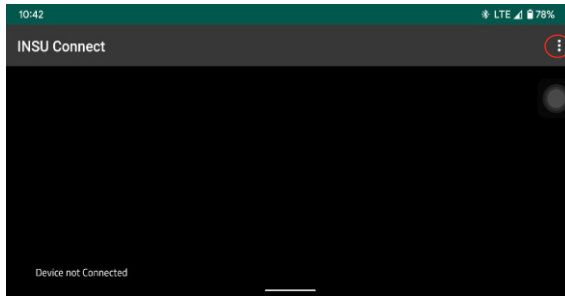

- Then in the drop down menu press the connect button.

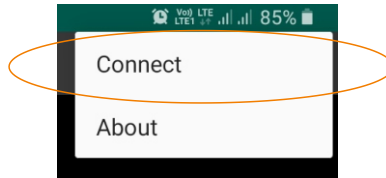

- Then the following screen will be displayed and the meter is now connected to your phone.

