

EM 3490 DS- Three Phase (3W/4W) Three Phase Dual Source Energy Meter Installation & Operating Instructions

Section	Contents
1.	Introduction
2.	Measurement Reading Screens
3.	Programming
3.1	Password Protection
3.2	Menu selection
3.2.1	System Parameter selection screen
3.2.1.1	System type
3.2.1.2	Potential transformer Primary value
3.2.1.3	Potential transformer secondary value
3.2.1.4	Current transformer Primary value
3.2.1.5	Energy Display on modbus
3.2.1.6	Energy Digit Rollover(reset) count
3.2.1.7	Auto Scrolling
3.2.2	Communication Parameter selection screen
3.2.2.1	Address Setting
3.2.2.2	RS 485 Baud rate
3.2.2.3	RS 485 Parity selection
3.2.3	Reset Parameter selection screen
3.2.3.1	Resetting Parameter
3.2.4	Relay Output parameter selection screen
3.2.4.1	Pulse Duration (width) selection
3.2.4.2	Pulse rate divisor
3.2.5	Quit screen
4.	Relay Output (Optional)
4.1	Pulse Output
5.	RS 485 (Modbus) Output
5.1	User assignable Modbus Register
6.	Phaser Diagram
7.	Installation
7.1	EMC Installation Requirements
7.2	Case Dimensions and Panel Cut-out
7.3	Wiring
7.4	Auxiliary Supply
7.5	Fusing
7.6	Earth / Ground Connections
8.	Connection Diagrams
8.1	Network Wiring
8.2	Generator Sense Connection diagram
9.	Specification
10.	Connection for Optional Pulse output / RS 485

1. Introduction

15000191_Rev.G - 8/12

The EM 3490 DS is a panel mounted 96 x 96mm DIN Quadratic Dual source energy meter. It accumulates Active energy, Run hour, On Hour, No of Interruption in completely different registers for Utility (Normal mode) & Generator (in power back up) in three phase network.

The switch over from utility to generator or vice versa is sensed through the sensing Voltage applied at Generator sense terminal at the rear side of the EM 3490 DS. If voltage is present at sensing terminal EM 3490 DS will measure Generator parameters and if absent then it will measure utility parameters.

The instrument also measures AC Voltage, AC Current, Frequency, Power, Power factor, Phase Angle, Apparent Energy (Utility & Generator) which can be accessed via Modbus. All voltage & Current measurements are True RMS upto 15th harmonic.

Ultra high brightness LED display.

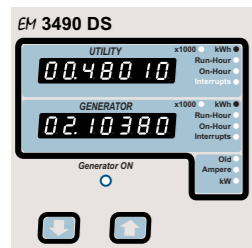

DownKey UpKey

EM 3490 DS can be configured & Programmed at site for the following :
PT Primary, PT Secondary 3 phase 3W or 3 Phase 4W system.

The front panel has two push buttons through which the user may scroll through the available measurement readings, Can reset the energy & configure the product. It also has "Generator On" Led which indicates energy integration mode.
LED ON : Generator On & energy is integrated in Generator counter.
LED OFF : Generator Off energy is integrated

TABLE 1:

Measured Parameters	Units of measurement
System Voltage	Volts
System Current	Amps
Voltage VL1-N(4wire only)	Volts
Voltage VL2-N(4wire only)	Volts
Voltage VL3-N(4wire only)	Volts
Voltage VL1-L2	Volts
Voltage VL2-L3	Volts
Voltage VL3-L1	Volts
Current L1	Amps
Current L2	Amps
Current L3	Amps
Neutral Current (4 wire only)	Amps
Frequency	Hz
Active Power (System / Phase (4 wire only))	Kwatts
Reactive Power (System / Phase (4 wire only))	KVAr
Apparent Power (System / Phase (4 wire only))	KVA
Power Factor (System / Phase (4 wire only))	—
Phase Angle (System / Phase (4 wire only))	Degree
Active Energy (Utility / Generator)	kWh
Apparent Energy (Utility / Generator)	kVAh
Run Hour (Utility / Generator/Total)	hours:min
On Hour (Utility / Generator/Total)	hours:min
Number of Interruptions (Utility / Generator)	Counts
Old Active Energy (Utility / Generator)	kWh
Old Run Hour (Utility / Generator/Total)	hours:min
Old On Hour (Utility / Generator/Total)	hours:min
Old Number of Interruptions (Utility / Generator)	Counts

2. Measurement Reading Screens

In normal operation the user is presented with one of the measurement reading screens out of several screens. These screens may be scrolled through one at a time in incremental order by pressing the "Up key" and in decremental order by pressing "Down key".

Screen 1 : Active Energy (kWh)

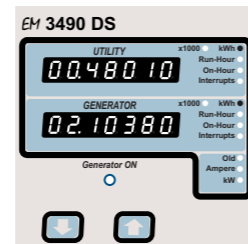

"Generator ON" LED:- OFF
Energy is integrated in Utility counter

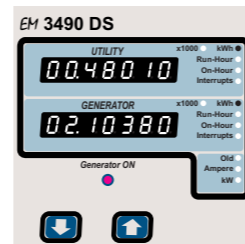

"Generator ON" LED:- ON
Energy is integrated in Generator counter

Screen 2 : Run-Hour (hh:mm:ss)

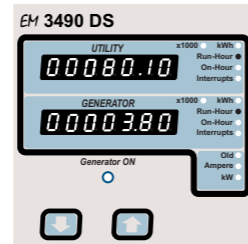

"Generator ON" LED:- OFF
Run-Hour is integrated in Utility counter

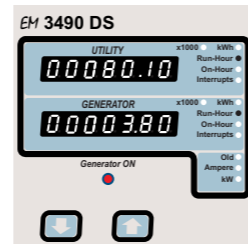

"Generator ON" LED:- ON
Run-Hour is integrated in Generator counter

Screen 3 : Run-Hour Total ,

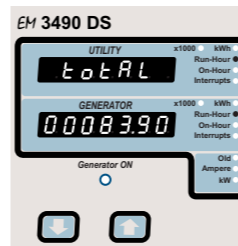

Total Run-Hour = Utility Run-Hour + Generator Run-Hour

Screen 4 : On-Hour (hh:mm:ss)

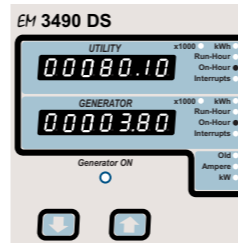

"Generator ON" LED:- OFF
On-Hour is integrated in Utility counter

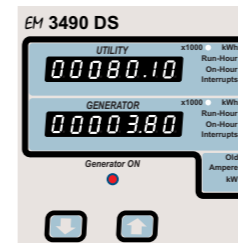

"Generator ON" LED:- ON
On-Hour is integrated in Generator counter

Screen 5 : On-Hour (hh:mm:ss)

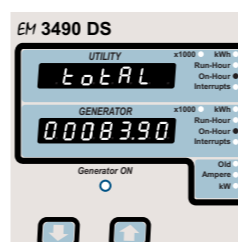

Total On-Hour = Utility On-Hour + Generator On-Hour

Screen 6 : Count for number of times Generator and Utility got interrupted

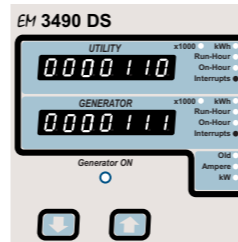

Screen 7 : Phase 1 Current

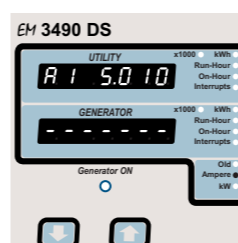

"Generator ON" LED:- OFF
Utility Phase 1 Current

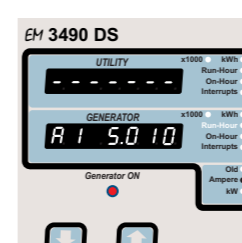

"Generator ON" LED:- ON
Generator Phase1 Current

Screen 8 : Phase 2 Current

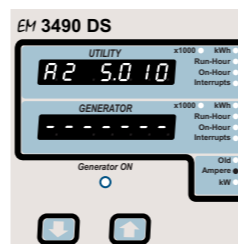

"Generator ON" LED:- OFF
Utility Phase 2 Current

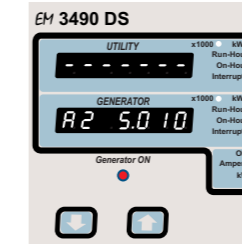

"Generator ON" LED:- ON
Generator Phase 2 Current

Screen 9 : Phase 3 Current

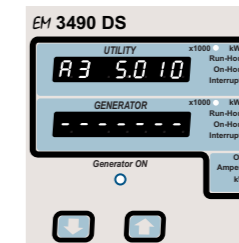

"Generator ON" LED:- OFF
Utility Phase 3 Current

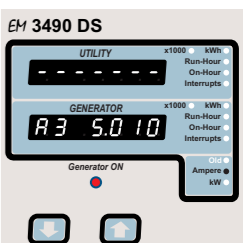

"Generator ON" LED:- ON
Generator Phase 3 Current

Screen 10 : System Current

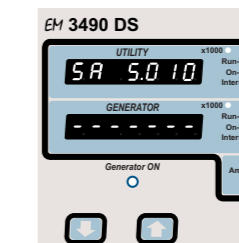

"Generator ON" LED:- OFF
Utility System Current

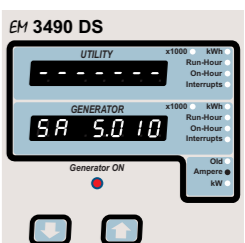

"Generator ON" LED:- ON
Generator System Current

Screen 11 : Phase 1 Active Power

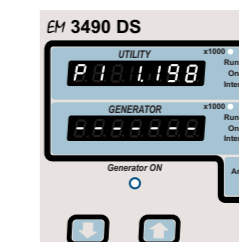

"Generator ON" LED:- OFF
Utility Phase 1 Active Power

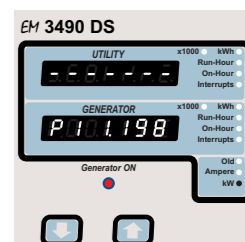

"Generator ON" LED:- ON
Generator Phase1 Active Power

Screen 12 : Phase 2 Active Power

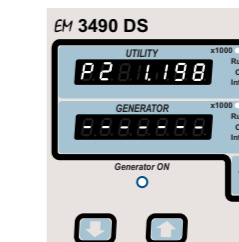

"Generator ON" LED:- OFF
Utility Phase 2 Active Power

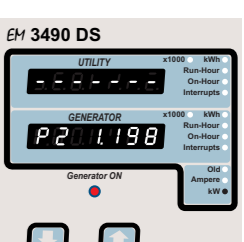

"Generator ON" LED:- ON
Generator Phase2 Active Power

Screen 13 : Phase 3 Active Power

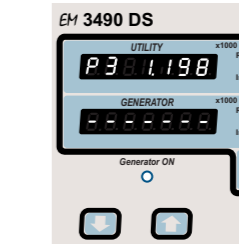

"Generator ON" LED:- OFF
Utility Phase 3 Active Power

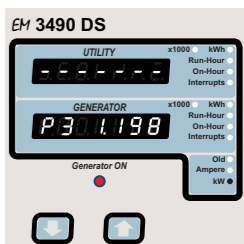

"Generator ON" LED:- ON
Generator Phase 3 Active Power

Screen 14 : System Active Power

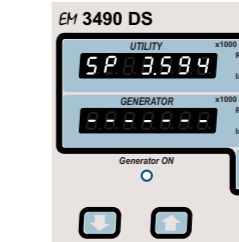

"Generator ON" LED:- OFF
Utility System Active Power

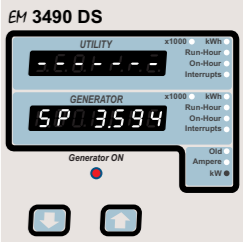

"Generator ON" LED:- ON
Generator System Active Power

Screen 15 : Active energy old count

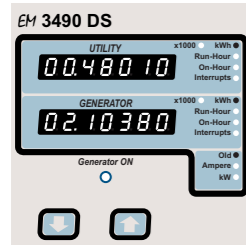

"Active energy old" count for utility and generator shows count stored, while resetting active energy count for both utility and generator. Or it may show the count stored when either utility or generator active energy count got overflowed

Screen 16 : Run-Hour old count

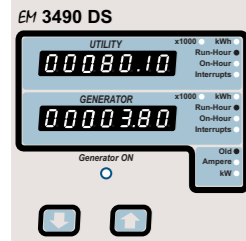

"Run-Hour old" count for utility and generator shows count stored, while resetting Run-Hour count for both utility and generator. Or it may show the count stored when either utility or generator Run-Hour count got overflowed

Screen 17 : Run-Hour Total old count

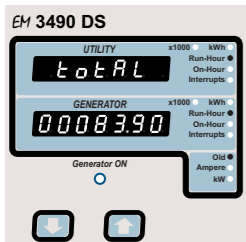

"Run-Hour Total old" count for utility and generator shows total Run-Hour count stored, while resetting Run-Hour count for both utility and generator. Or it may show the count stored when either utility or generator Run-Hour count got overflowed

Screen 18 : On-Hour old count

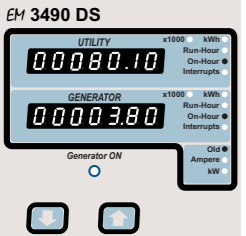

"On-Hour old" count for utility and generator shows On-Hour count stored, while resetting On-Hour count for both utility and generator. Or it may show the count stored when either utility or generator On-Hour count got overflowed

Screen 19 : On-Hour Total old count

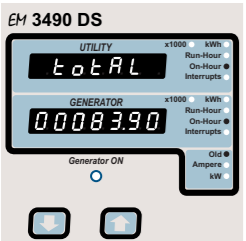

"On-Hour Total old" count for utility and generator shows total On-Hour count stored, while resetting On-Hour count for both utility and generator. Or it may show the count stored when either utility or generator On-Hour count got overflowed

Screen 20 : Old Count for number of times Generator and Utility got interrupted

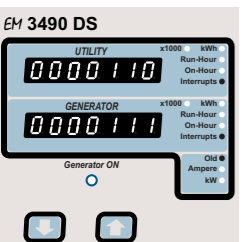

"Interrupt old" count for utility and generator shows interrupt count stored, while resetting interrupt count for both utility and generator. Or it may show the count stored when either utility or generator interrupt count got overflowed

Screen 21 .Phase Rotation Error screen :

Meter shows phase rotation error if the phase sequence R-Y-B (L1-L2-L3) is not maintained

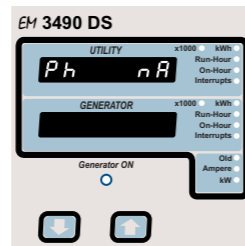

This Screen indicates that all three phases (Voltages) are absent.

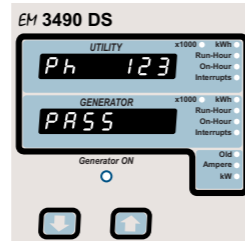

Correct Phase sequence :

This Screen indicates the phase sequence connected to meter is correct. If phase sequence is wrong this screen is useful to get correct phase sequence by interchanging connection & verifying it with screen.

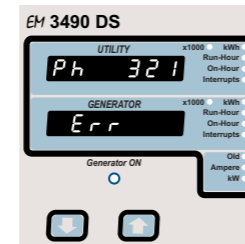

This screen indicates that Phase sequence is incorrect.

User must check this screen in order to get correct readings When meter is connected.

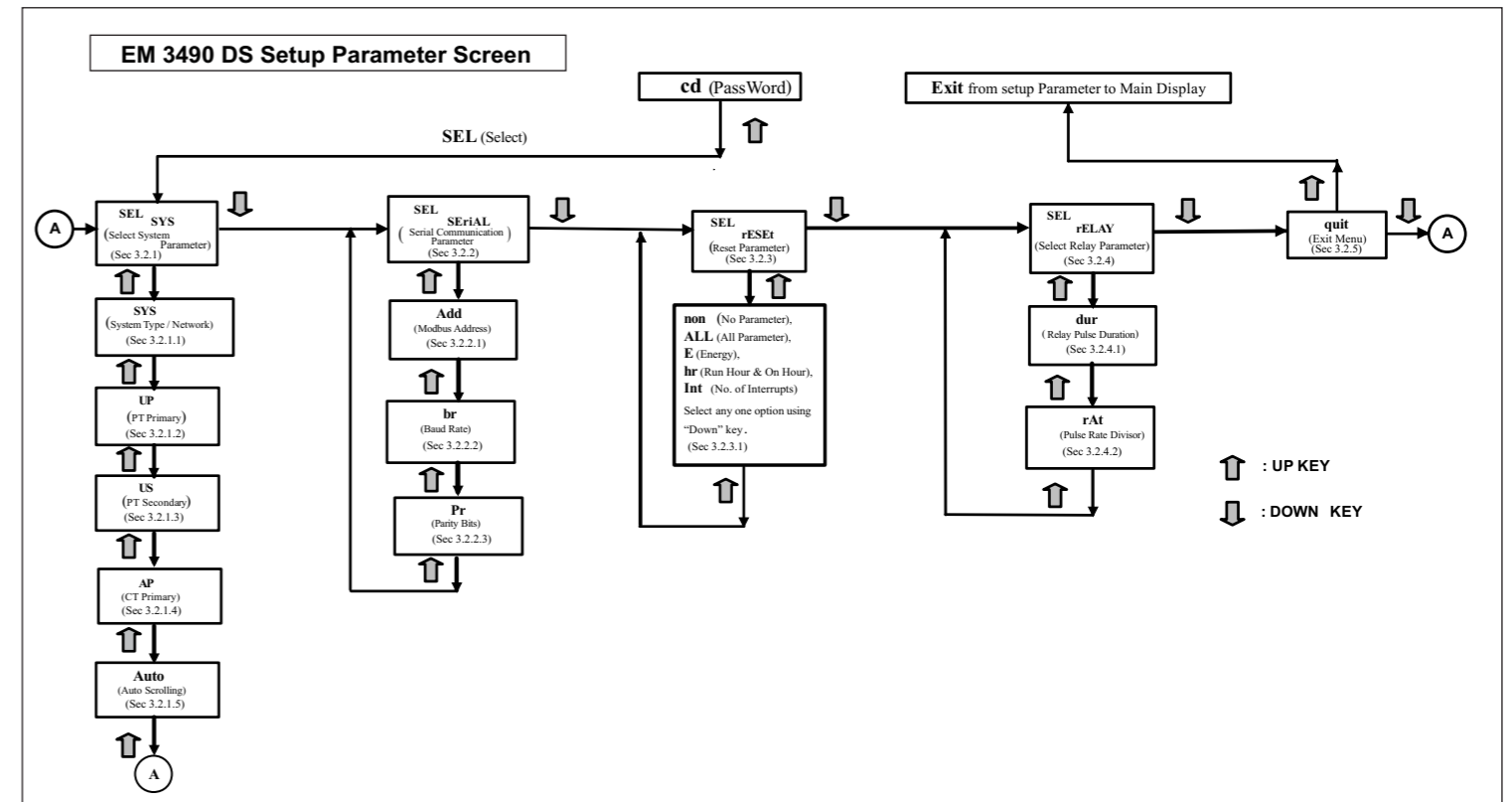

3. Programming

The following sections comprise step by step procedures for configuring the EM 3490 DS for individual user requirements.

To access the set-up screens press and hold the "Down" and "Up" Key simultaneously for 5 seconds. This will take the User into the Password Protection Entry Stage (Section 3.1).

3.1. Password Protection

Password protection can be enabled to prevent unauthorised access to set-up screens, by default password protection is not enabled.

Password protection is enabled by selecting a four digit number other than 0000, setting a password of 0000 disables the password protection.

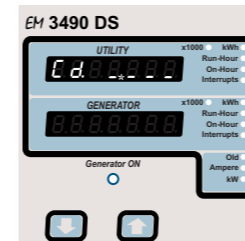

Enter Password, prompt for first digit. (* Denotes that decimal point will be flashing).

Press the "Down" key to scroll the value of the first digit from 0 through to 9, the value will wrap from 9 round to 0.

Press the "Up" key to advance to next digit.

In the special case where the Password is "0000" pressing the "Up" key when prompted for the first digit will advance to the "Password Confirmed" screen.

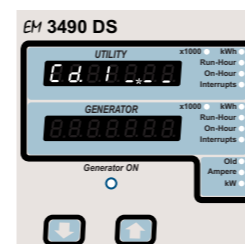

Enter Password, first digit entered, prompt for second digit. (* Denotes that decimal point will be flashing).

Use the "Down" key to scroll the value of the second digit from 0 through to 9, the value will wrap from 9 round to 0.

Press the "Up" key to advance to next digit.

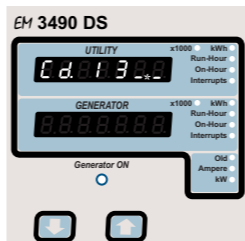

Enter Password, second digit entered, prompt for third digit. (* Denotes that decimal point will be flashing).

Use the "Down" key to scroll the value of the third digit from 0 through to 9, the value will wrap from 9 round to 0.

Press the "Up" key to advance to next digit.

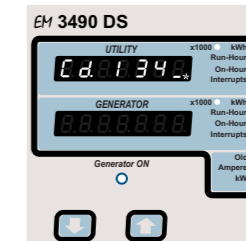

Enter Password, third digit entered, prompt for fourth digit. (* Denotes that decimal point will be flashing).

Use the "Down" key to scroll the value of the fourth digit from 0 through to 9, the value will wrap from 9 round to 0.

Press the "Up" key to advance to verification of the password.

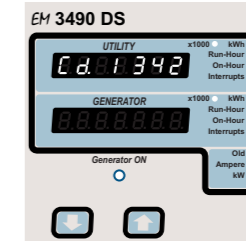

Enter Password, fourth digit entered, awaiting verification of the password.

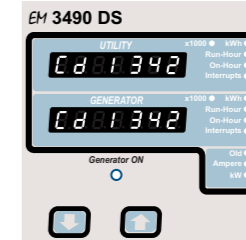

Password confirmed.

Pressing "Down" key will advance to the "New / change Password" entry stage.

Pressing the "Up" key will advance to the Menu selection screen. (See section 3.2).

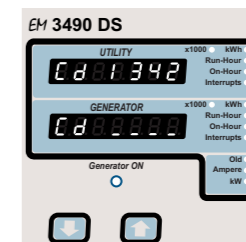

Password Incorrect.

The unit has not accepted the Password entered.

Pressing the "Down" key will return to the Enter Password stage.

Pressing the "Up" key exits the Password menu and returns operation to the measurement reading mode.

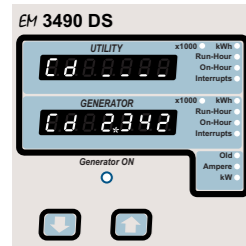

New / Change Password

(*Decimal point indicates that this will be flashing).

Pressing the "Down" key will scroll the value of the first digit from 0 through to 9, the value will wrap from 9 round to 0.

Pressing the "Up" key to advance the operation to the next digit and sets the first digit, in this case to "2"

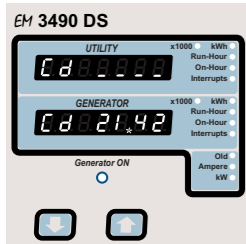

New / Change Password, first digit entered, prompting for second digit. (*Decimal point indicates that this will be flashing).

Pressing the "Down" key will scroll the value of the second digit from 0 through to 9, the value will wrap from 9 round to 0.

Pressing the "Up" key to advance the operation to the next digit and sets the second digit, in this case to "1"

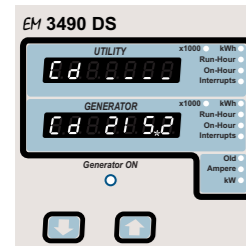

New / Change Password, second digit entered, prompting for third digit. (*decimal point indicates that this will be flashing).

Pressing the "Down" key will scroll the value of the third digit from 0 through to 9, the value will wrap from 9 round to 0.

Pressing the "Up" key to advance the operation to the next digit and sets the third digit, in this case to "5"

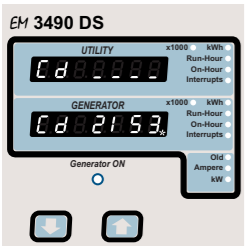

New / Change Password, third digit entered, prompting for fourth digit. (* denotes that decimal point will be flashing).

Pressing the "Down" key will scroll the value of the fourth digit from 0 through to 9, the value will wrap from 9 round to 0.

Pressing the "Up" key to advance the operation to the "New Password Confirmed" and sets the fourth digit, in this case to "3".

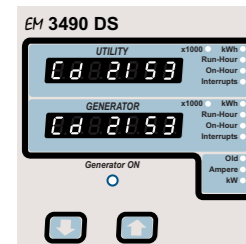

New Password confirmed.

Pressing the "Down" key will return to the "New/Change Password".

Pressing the "Up" key will advances to the Menu selection screen.(see section 3.2).

3.2 Menu selection.

3.2.1 System Parameter selection screen.

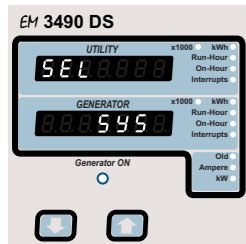

This menu screen is used to select the different system Parameter like "system type," "CT Ratio," "PT Ratio",

Pressing the "Up" key allows the user to set Different system parameters. (see section 3.2.1.1 to 3.2.1.5)

Pressing the "Down" key will advance to Communication selection screen (see section 3.2.2)

3.2.2 Communication Parameter selection screen.

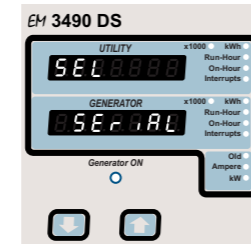

This menu screen is used to select the different communication parameters like "Address selection", "RS485 Parity selection", "RS485 baud rate"

Pressing the "Up" key allows the user to set different Communication parameters (see section 3.2.2.1 to 3.2.2.3)

Pressing the "Down" key will advance to Reset parameter Screen. (see section 3.2.3)

3.2.3 Reset Parameter selection screen.

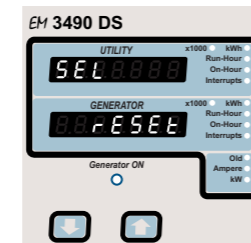

This menu screen is used to Reset the different parameters .

Pressing the "Up" key allows the user to Reset different system parameters (see section 3.2.3.1)

Pressing the "Down" key " will advance to Output Option selection screen (see section 3.2.4).

3.2.4 Relay Output Parameter selection screen.

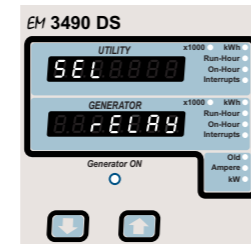

This menu screen will allow the user to select different Parameter related to Relay Output.

Pressing the "Up" key allows the user to select & Configure the relay output option (see section 3.2.4.1)

Pressing the "Down" key will advance to Quit screen. (see section 3.2.5)

3.2.5 Quit screen.

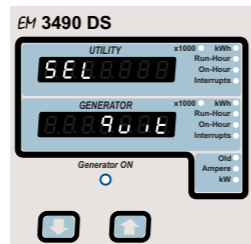

This screen allows user to Quit from Menu.

Pressing the "Up" key will allow the user to Quit from menu & return to measurement screen.

Pressing the "Down" key will advance to system Parameter Selection screen (see section 3.2.1)

3.2.1 System parameters Selection

3.2.1.1 System Type

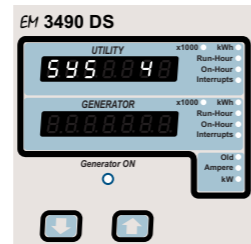

This screen is used to set the system type . System type "3" for 3 phase 3 wire & "4" for 3 phase 4 wire system.

Pressing the "Up" key accepts the present value and advances to the "Potential transformer primary value Edit" menu (see section 3.2.1.2)

Pressing the "Down" key will enter the system type edit mode and scroll the values through values available .

Pressing the "Up" key advances to the system type confirmation menu.

System Type Confirmation

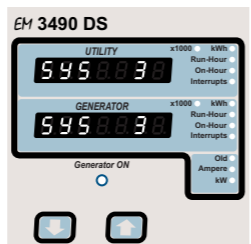

This screen will only appear following the edit of system type. If system type is to be Downed again,

Pressing the "Up" key sets the displayed value and will advance to "Potential Transformer Primary Value Edit" menu. (See section 3.2.1.2)

Pressing the "Down" key will return to the system type edit stage by blanking the bottom line of the display

3.2.1.2 Potential Transformer Primary Value

The nominal full scale voltage which will be displayed as the L1-N, L2-N and L3-N for a four wire (Ln) system or as L1-2, L2-3 and L3-1 in a three wire(LL) system. This screen enables the user to display the line to neutral and line to line voltages inclusive of any transformer ratios, the values displayed represent the voltage in kilovolts (note the x1000 enunciation).

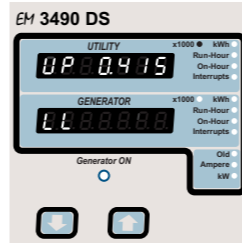

Pressing the "Up" key accepts the present value and advances to the "potential Transformer secondary Value edit" menu. (See Section 3.2.1.3)

Pressing the "Down" key will enter the "Potential Transformer Primary Value Edit" mode.

Initially the "multiplier must be selected, pressing the "Down" key will move the decimal point position to the right until it reaches ###.# after which it will return to ##.##.

Pressing the "Up" key accepts the present multiplier (decimal point position) and advances to the "potential Transformer primary Digit Edit" mode.

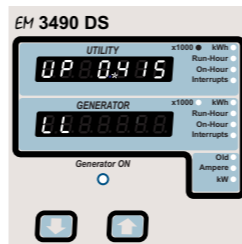

Potential Transformer primary Digit Edit

Pressing the "Down" key will scroll the value of the most significant digit from 0 through to 9 unless the presently displayed Potential Transformer Primary Value together with the Current Transformer Primary Value, previously set, would result in a maximum power of greater than 1000 MVA per phase in which case the digit range will be restricted.

Pressing the "Up" key accepts the present value at the cursor position and advances the cursor to the next less significant digit.

Note : the flashing decimal point indicates the cursor position, a steady decimal point will be present to identify the scaling of the number until the cursor position coincides with the steady decimal point position. At this stage the decimal point will flash.

When the least significant digit has been set pressing the "Up" key will advance to the "Potential Transformer Primary Value Confirmation" stage.

Screen showing display of 0.120 kV i.e. 120 Volts indicating steady decimal point and cursor flashing at the "hundreds of volts" position.

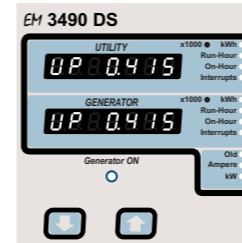

Potential Transformer Primary Value Confirmation

This screen will only appear following an edit of the Potential Transformer Primary Value.

If the scaling is not correct, pressing the "Down" key will return to the "Potential Transformer Primary Value Edit" stage with the digits flashing indicating that the multiplier (decimal point position) should be selected.

Pressing the "Up" key sets the displayed value and will advance to the Potential Transformer secondary Value (See Section 3.2.1.3)

Note : 0.120 kV i.e. 120 V_{L-N} for 4W
120 V_{L-L} for 3W

3.2.1.3 Potential Transformer secondary Value

The value must be set to the nominal full scale secondary voltage which will be obtained from the Transformer when the potential transformer(PT)primary is supplied with the voltage defined in 3.2.1.2 potential transformer primary voltage.The ratio of full scale primary to full scale secondary is defined as the transformer ratio.

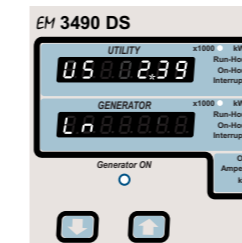

Pressing the "Up" key accepts the present value and advances to the "Current Transformer Primary Value edit" menu. (See Section 3.2.1.4)

Note that the range of instrument is from 140 to 277V for 239 VL-N. Please refer the table below for different ranges.

Pressing the "Down" key will enter the "Potential Transformer Secondary Value Edit" mode. Down" key will scroll the value of the most significant digit From available range of PT secondary value

Pressing the "Up" key accepts the present value at the cursor position and advances the cursor to the next less significant digit.

Potential Transformer secondary ranges for various Input Voltages

110V L-L (63.5V L-N)	100 - 120V L-L (57V - 69V L-N)
230V L-L (133.0V L-N)	121 - 239V L-L (70V - 139V L-N)
415V L-L (239.6V L-N)	240 - 480V L-L (140V - 277V L-N)

Note : the flashing decimal point indicates the cursor position, a steady decimal point will be present to identify the scaling of the number until the cursor position coincides with the steady decimal point position. At this stage the decimal point will flash.

When the least significant digit has been set pressing the "Up" key will advance to the "Potential Transformer secondary Value Confirmation" stage.

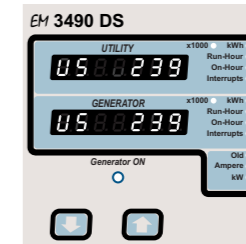

Potential Transformer Secondary Value Confirmation

This screen will only appear following an edit of the Potential Transformer Secondary Value.

If the scaling is not correct, pressing the "Down" key will return to the "Potential Transformer Secondary Value Edit"

Pressing the "Up" key sets the displayed value and will advance to the current Transformer Primary Value (See Section 3.2.1.4)

3.2.1.4 Current Transformer Primary Value

The nominal Full Scale Current that will be displayed as the Line currents. This screen enables the user to display the Line currents inclusive of any transformer ratios, the values displayed represent the Current in Amps.

Pressing the "Up" key accepts the present value and advances to the Auto scrolling Of displayed screen (See Section 3.2.1.5)

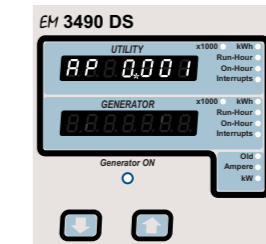

Pressing the "Down" key will enter the "Current Transformer Primary Value Edit" mode. This will scroll the value of the most significant digit from 0 through to 9, unless the presently displayed Current Transformer Primary Value together with the Potential Transformer Primary Value results in a maximum power of greater than 1000 MVA in which case the digit range will be restricted, the value will wrap. Example: If primary value of PT is set as 400kV (max value) then primary value of Current is restricted to 1736A.

Pressing the "Up" key will advance to the next less significant digit. (* Denotes that decimal point will be flashing).

The "Maximum Power" restriction of 1000 MVA refers to 120% of nominal current and 120% of nominal voltage, i.e. 694.4 MVA nominal power per phase.

When the least significant digit had been set, pressing the "Up" key will advance to the "Current Transformer Primary Value Confirmation" stage.

The minimum value allowed is 1, the value will be forced to 1 if the display contains zero when the "Up" key is pressed.

Current Transformer Primary Value Confirmation.

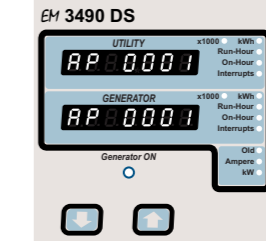

This screen will only appear following an edit of the Current Transformer Primary Value.

If the scaling is not correct, Pressing the "Down" key will return to the "Current Transformer Primary Value Edit" stage with the most significant digit highlighted (associated decimal point flashing) and the bottom line of the display will be blanked.

Pressing the "Up" key sets the displayed value and will advance to the "Energy display on modbus" menu. (See Section 3.2.1.5)

3.2.1.5. Energy Display on modbus

This screen enable user to set energy in terms of Wh / KWh / MWh on RS 485 Output depending as per the requirement.

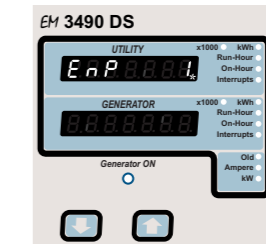

Pressing "Up" key accepts the presents value and advances to the "Energy digit Rollover(reset) count" menu (See section 3.2.1.6).

Pressing the "Down" key will enter the "Energy Display On Modbus Edit" mode and scroll the value through the values 1,2 & 3 wrapping back to 1

- 1: Energy In Wh
- 2: Energy in KWh
- 3: Energy in MWh.

Pressing the "Up" key advances to the "Energy Display On Modbus Confirmation" menu.

Energy Display On Modbus Confirmation.

This screen will only appear following an edit of the Energy Display On Modbus.

Pressing the "Down" key will enter the "Energy Display On Modbus Edit" stage by blanking the bottom line of the display.

Pressing "Up" key sets the displayed value and will advance to the "Energy digit Rollover(reset) count" menu. (See section 3.2.1.6)

Note : Default value is set to '1' i.e. Energy on Modbus will be in terms of Wh/VAh/VAh/Ah resp.

3.2.1.6 Energy Digit Rollover(reset) count :

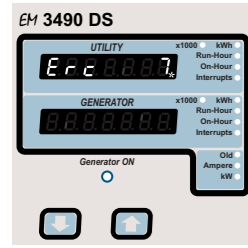

This screen enables user for setting maximum energy count after which energy will rollback to zero depends upon setting of Wh,KWh, & MWh.
Pressing the "Up" key sets the displayed value and will advance to the "Auto Scrolling" selection (See Section 3.2.1.7)

Pressing the "Down" key will enter the Energy digit reset count edit mode. This will scroll the value of reset count from 7 to 14 for Wh, from 7 to 12 for KWh & from 7 to 9 for MWh. Ex. If energy display on modbus is set Wh & It will set Energy digit count to 10 then energy will reset after "9,999,999,999" & then will rollback to zero

Pressing "Up" key " will advance to Energy digit reset count confirmation screen.

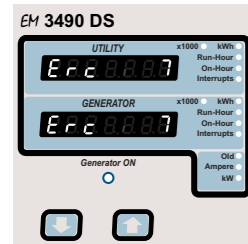

Energy Digit Rollover(reset) count Confirmation.
Pressing the "Down" key will re-enter Energy digit Rollover(reset) count edit mode.

Pressing the "Up" key sets the displayed value and will advance to the "Auto Scrolling" selection (See Section 3.2.1.7)

- Note :**
- 1) Default value is set to "14" i.e if energy count crosses 14 digit it will rollback to zero.
 - 2) Energy displays on modbus is set to (2) & energy digit reset count is set to 12. Energy screen on display will show "-----" i.e Energy overflow when energy crosses the 11 digit count.
 - 3) Energy displays on modbus is set to (3) & energy digit reset count is set to 9. Energy screen on display will show "-----" i.e Energy overflow when energy crosses the 8 digit count.

3.2.1.7 Auto Scrolling :

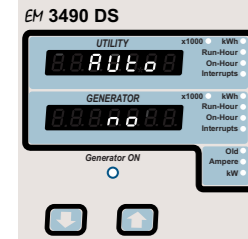

This screen allows user to enable screen scrolling.

Auto scrolling Edit.

Pressing "Up" key accepts the present status and advance to System parameter selection screen (See Section 3.2.1)

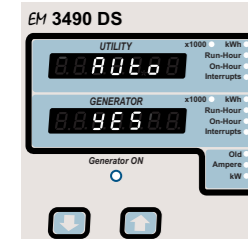

Pressing the "Down" key will enter the "Auto Screen Scrolling Edit" and toggle the status 'Yes' and 'No'.

Pressing the "Up" key will select the status displayed and advance to System parameter selection screen (See Section 3.2.1)

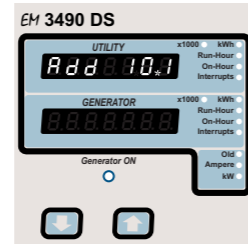

Enter Address, second digit entered, prompt for third digit (* Denotes that decimal point will be flashing).

Use the "Down" key to scroll the value of the third digit

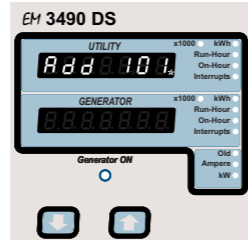

Enter Address for third digit .

Press the "Up" key to advance to Address confirmation Screen.

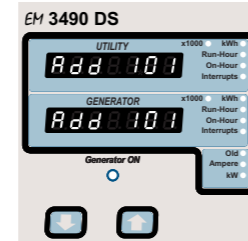

Address confirmation Screen.

This Screen confirms the Address set by user .

Press the "Up" key to advance to next Screen "RS485 Baud Rate" (See Section 3.2.2.2)

Pressing the "Down" key will reenter the "Address Edit" mode.

3.2.2.2 RS 485 Baud Rate :

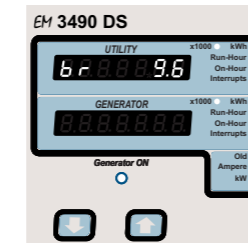

This screen allows the user to set Baud Rate of RS 485 port. The values displayed on screen are in kbaud ..

Pressing "Up" key accepts the present value and advance to the Parity Selection (See Section 3.2.2.3)

Pressing the "Down" key will enter the "Baud Rate Edit" mode and scroll the value through 2.4, 4.8, 9.6 , 19.2 and back to 2.4

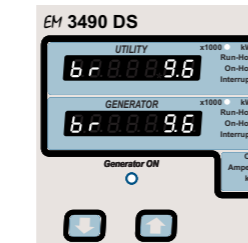

RS 485 Baud Rate confirmation :

Pressing "Down" key will be re-enter into the Baud Rate Edit mode

Pressing the "Up" key will select the value and advances to the Parity Selection (See Section 3.2.2.3).

3.2.2 Communication Parameter Selection :

3.2.2.1 Address Setting : This screen applies to the RS 485 output only. This screen allows the user to set RS485 parameter for instruments

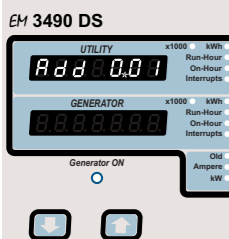

The range of allowable address is 1 to 247 .

Enter Address, prompt for first digit. (* Denotes that decimal point will be flashing).

Press the "Down" key to scroll the value of the first digit

Press the "Up" key to advance to next digit.

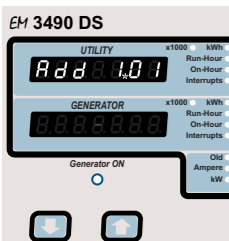

Enter Address, first digit entered, prompt for second digit (* Denotes that decimal point will be flashing).

Use the "Down" key to scroll the value of the second digit

Press the "Up" key to advance to next digit.

3.2.3 Reset Parameter Selection :

3.2.3.1 Resetting Parameter

The following screens allow the users to reset the all Energy ,hour (Run hour & On hour), No.of Interrupts

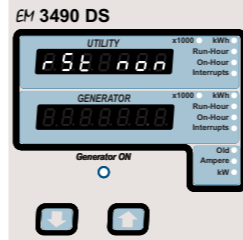

Reset (None)

Pressing "Up" key advances to Reset Parameter selection screen (see section 3.2.3)

Pressing the "Down" key will enter the "Reset option" mode and scroll through Parameter and wrapping back to None.

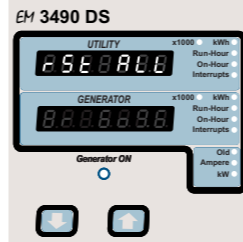

Reset option select, (Resets ALL resettable parameter)

The user has scrolled through to the "ALL" .

Pressing "Up" key will select the value and advance to the "Reset ALL Confirmation" Mode & Will reset all resettable parameter.

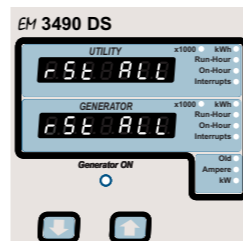

Reset ALL Confirmation.

Pressing the "Down" key will re-enter the Reset option Select mode.

Pressing "Up" key will jump back to the Reset Parameter selection screen (see section 3.2.3).

These reseted parameters last displayed value will get stored in "Old Registers". Which will hold kWh, Old Run our, Total Run Hour, Old On hour, Total On-Hour in respective register For future reference.

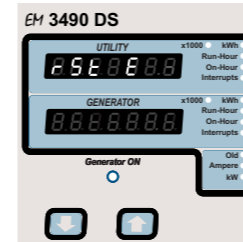

Reset option select, (Resets generators & Utility Energies)

The user has scrolled through to the "E" Energy value.

Pressing "Up" key will select the value and advance to the "Reset Energy Confirmation" Mode & resets generators & Utility Energies

Integrated Energy at the moment of resetting energy will

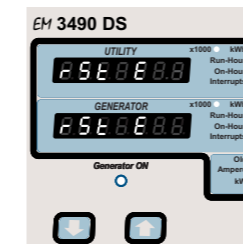

Reset Energy Confirmation.

Pressing the "Down" key will re-enter the "Reset option" mode.

Pressing "Up" key will jump back to the Reset Parameter selection screen (see section 3.2.3).

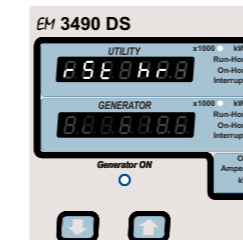

Reset option select, hr (ON Hour & Run Hour)

The user has scrolled through to the "hr"

Pressing "Up" key will select the value and advance to the "Reset hr Confirmation" Mode & Will reset On hour & Run Hour both.

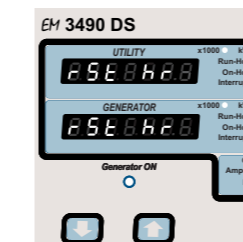

Reset hr Confirmation

Pressing the "Down" key will re-enter the "Reset option Select mode.

Pressing "Up" key will jump back to the Reset Parameter selection screen (see section 3.2.3).

Accumulated Run Hour at this moment will be copied to "Old Run Hour register" & will be available for future reference

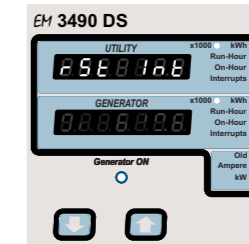

Reset option select, (Reset Number of Interrupt)

The user has scrolled through to the "intr"

Pressing "Up" key will select the value and advance to the "reset Interrupt Confirmation" Mode & Will reset number of Auxiliary supply interruption count.

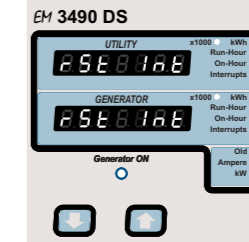

Reset Interrupt Confirmation

Pressing the "Down" key will re-enter the "Reset parameter Selection"(see section 3.2.3).

Pressing "Up" key will jump back to the Reset Parameter selection screen (see section 3.2.3).

Resetted value of Interruption will be stored in "Old Interruption Register" for future reference

3.2.4. Relay output menu

3.2.4.1 Pulse Duration Selection:

This screen applies only to the Pulsed output mode of both the relay This screen allows the user to set Relay energisation time in milliseconds.

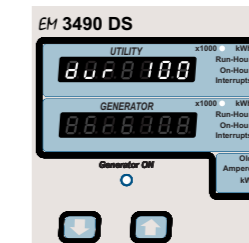

Pulse Duration Edit.

Pressing "Up" key accepts the present value and advance to pulse rate selection menu (see section 3.2.4.2).

Pressing the "Down" key will enter the "Pulse Duration Edit" mode and scroll the value through 60, 100, 200 and wrapping back to 60.

Pressing the "Up" key will select the value and advances to "Pulse Duration Confirmation".

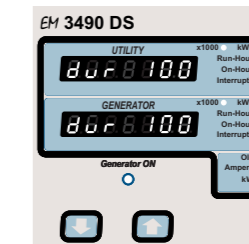

Pulse Duration Confirmation.

This screen will only appear following an edit of the Pulse duration.

pressing the "Down" key will re-enter the "Pulse Duration Edit" mode.

Pressing "Up" key set displayed value and Will advance to pulse rate selection menu (See section 3.2.4.2)

3.2.4.2 Pulse Rate

This screen applies to the Relay Output option only. The screen allows user to set the energy pulse rate divisor. Divisor values can be selected through 1,10,100,1000.

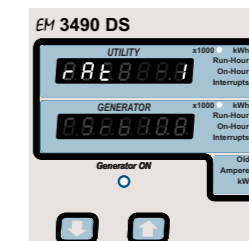

Pressing "Up" key accepts the presents value and advances to the "Relay Output Option Menu" (See section 3.2.4.).

Pressing the "Down" key will enter the "Pulse rate divisor Edit" mode and scroll the value through the values 1,10,100, 1000 wrapping back to 1.

Pressing the "Up" key advances to the "Pulse rate Divisor Confirmation" menu.

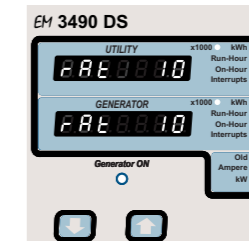

Pulse Rate Divisor Confirmation.

This screen will only appear following an edit of the Pulse rate divisor.

If the Pulse rate shown is not correct, pressing the "Down" key will return to the "Pulse rate divisor Edit" stage by blanking the bottom line of the display.

Pressing "Up" key sets the displayed value and will advance to the "Relay output Option Menu". (See section 3.2.4)

4. Relay output (Optional) :

4.1 Pulse Output :

Pulse output is the potential free, very fast acting relay contact which can be used to drive an external mechanical counter for energy measurement. EM 3490 DS has two pulse outputs one for utility and another for generator.

Relay Contact	One normally open
Pulse Duration	60ms , 100ms or 200ms

TABLE 3 : Energy Pulse Rate Divisor

1. For Energy Output in Wh

Divisor	Pulse rate	
	Pulse	System Power*
1	1per Whr	Up to 3600W
	1per kWhr	Up to 3600kW
	1per MWhr	Above 3600kW
10	1per 10Whr	Up to 3600W
	1per 10kWhr	Up to 3600kW
	1per 10MWhr	Above 3600kW
100	1per 100Whr	Up to 3600W
	1per 100kWhr	Up to 3600kW
	1per 100MWhr	Above 3600kW
1000	1per 1000Whr	Up to 3600W
	1per 1000kWhr	Up to 3600kW
	1per 1000MWhr	Above 3600kW
Pulse Duration 60 ms,100 ms or 200 ms		

2. For Energy Output in KWh

Divisor	Pulse rate	
	Pulse	System Power*
1	1 per kWhr	Up to 3600W
	1 per 1000kWhr	Up to 3600kW
	1per 1000MWhr	Above 3600kW

3. For Energy Output in MWh

Divisor	Pulse rate	
	Pulse	System Power*
1	1per MWhr	Up to 3600W
	1per 1000MWhr	Up to 3600kW
	1per 1000GWhr	Above 3600kW

* System power = 3 x CT(Primary) x PT(Primary).-N for 3 Phase 4 Wire
System power = Root3 x CT(Primary) x PT(Primary).-L for 3 Phase 3 Wire

5. RS 485 (ModBus) Output :

EM 3490 DS supports MODBUS (RS485) RTU protocol(2-wire) .

Connection should be made using twisted pair shielded cable. All "A" and "B" connections are daisy chained together. The screens should also be connected to the "Gnd" terminal. To avoid the possibility of loop currents, an Earth connection should be made at one point on the network. Loop (ring) topology does not require any termination load. Line topology may or may not require terminating loads depending on the type and length of cable used. The impedance of the termination load should match the impedance of the cable and be at both ends of the line. The cable should be terminated at each end with a 120 ohm (1/4 Watt min.) resistor.

RS 485 network supports maximum length of 1.2km. Including the EM 3490DS, a maximum of 32 instruments can be connected in RS485 network. The permissible address range for EM 3490 DS s between 1 and 247 for 32 instruments. Broadcast Mode (address 0) is not allowed.

The maximum latency time of an EM 3490 DS is 200ms i.e. this is the amount of time that can pass before the first response character is output.

After sending any query through software (of the Master) , it must allow 200ms of time to elapse before assuming that the EM 3490 DS is not going to respond. If slave does not respond within 200 ms, Master can ignore the previous query and can issue fresh query to the slave.

The each byte in RTU mode has following format:

	8-bit binary, hexadecimal 0-9, A-F 2 hexadecimal characters contained in each 8-bit field of the message
Format of Data Bytes	4 bytes (32 bits) per parameter. Floating point format (to IEEE 754) Most significant byte first (Alternative least significant byte first)
Error Checking Bytes	2 byte Cyclical Redundancy Check (CRC)
Byte format	1 start bit, 8 data bits, least significant bit sent first 1 bit for even/odd parity 1 stop bit if parity is used; 1 or 2 bits if no parity

Communication Baud Rate is user selectable from the front panel between 2400, 4800, 9600, 19200 bps.

Function code :

03	Read Holding Registers	Read content of read /write location (4X)
04	Read input Registers	Read content of read only location (3X)
16	Presets Multiple Registers	Set the content of read / write locations (4X)

Exception Cases : An exception code will be generated when EM 3490 DS receives ModBus query with valid parity & error check but which contains some other error (e.g. Attempt to set floating point variable to an invalid value) The response generated will be "Function code" ORed with HEX (80H) . The exception codes are listed below

01	Illegal function	The function code is not supported by EM 3490 DS
02	Illegal Data Address	Attempt to access an invalid address or an attempt to read or write part of a floating point value
03	Illegal Data Value	Attempt to set a floating point variable to an invalid value

Accessing 3 X register for reading measured values:

Two consecutive 16 bit registers represent one parameter. Refer table 4 for the addresses of 3X registers (Parameters measured by the instruments). Each parameter is held in the 3X registers. Modbus Code 04 is used to access all parameters.

Example :
To read parameter ,
Volts 3 : Start address= 04 (Hex) Number of registers = 02

Note : Number of registers = Number of parameters x 2

Each Query for reading the data must be restricted to 20 parameters or less. Exceeding the 20 parameter limit will cause a ModBus exception code to be returned.

Query :

01 (Hex)	04 (Hex)	00 (Hex)	04(Hex)	00 (Hex)	02(Hex)	30 (Hex)	0A (Hex)
Device Address	Function Code	Start Address High	Start Address Low	Number of Registers Hi	Number of Registers Lo	CRC Low	CRC High

Start Address High : Most significant 8 bits of starting address of the parameter requested.

Start Address low :Least significant 8 bits of starting address of the parameter requested.

Number of register Hi : Most significant 8 bits of Number of registers requested.

Number of register Lo : Least significant 8 bits of Number of registers requested.

(Note : Two consecutive 16 bit register represent one parameter.)

Response: Volt3 (219.25V)

01 (Hex)	04 (Hex)	04 (Hex)	43 (Hex)	5B (Hex)	41 (Hex)	21 (Hex)	6F (Hex)	9B (Hex)
Device Address	Function Code	Byte Count	Data Register1 High Byte	Data Register1 Low Byte	Data Register2 High Byte	Data Register2 Low Byte	CRC Low	CRC High

Byte Count : Total number of data bytes received.

Data register 1 High Byte : Most significant 8 bits of Data register 1 of the parameter requested.

Data register 1 Low Byte : Least significant 8 bits of Data register 1 of the parameter requested.

Data register 2 High Byte : Most significant 8 bits of Data register 2 of the parameter requested.

Data register 2 Low Byte : Least significant 8 bits of Data register 2 of the parameter requested.

(Note : Two consecutive 16 bit register represent one parameter.)

Table 4 : 3 X register addresses (measured parameters)

Address (Register)	Parameter No.	Parameter	Modbus Start Address Hex		3P 4W	3P 3W
			High Byte	Low Byte		
30001	1	Volts 1	00	0	✓	✓
30003	2	Volts 2	00	2	✓	✓
30005	3	Volts 3	00	4	✓	✓
30007	4	Current 1	00	6	✓	✓
30009	5	Current 2	00	8	✓	✓
30011	6	Current 3	00	A	✓	✓
30013	7	W1	00	C	✓	X
30015	8	W2	00	E	✓	X
30017	9	W3	00	10	✓	X
30019	10	VA1	00	12	✓	X
30021	11	VA2	00	14	✓	X
30023	12	VA3	00	16	✓	X
30025	13	VAR1	00	18	✓	X
30027	14	VAR2	00	1A	✓	X
30029	15	VAR3	00	1C	✓	X
30031	16	PF1	00	1E	✓	X
30033	17	PF2	00	20	✓	X
30035	18	PF3	00	22	✓	X
30037	19	Phase Angle 1	00	24	✓	X
30039	20	Phase Angle 2	00	26	✓	X
30041	21	Phase Angle 3	00	28	✓	X
30043	22	Volts Ave	00	2A	✓	✓
30045	23	Volts Sum	00	2C	✓	✓
30047	24	Current Ave	00	2E	✓	✓
30049	25	Current Sum	00	30	✓	✓
30051	26	Watts Ave	00	32	✓	✓
30053	27	Watts Sum	00	34	✓	✓
30055	28	VA Ave	00	36	✓	✓
30057	29	VA Sum	00	38	✓	✓
30059	30	VAr Ave	00	3A	✓	✓
30061	31	VAr Sum	00	3C	✓	✓
30063	32	PF Ave	00	3E	✓	✓
30065	33	PF Sum	00	40	✓	X
30067	34	Phase Angle Ave	00	42	✓	✓
30069	35	Phase Angle Sum	00	44	✓	X
30071	36	Freq	00	46	✓	✓
30073	37	Wh (Utility)	00	48	✓	✓
30081	41	Vah (Utility)	00	50	✓	✓
30201	101	VL 1 - 2 (Calculated)	00	C8	✓	X
30203	102	VL 2 - 3 (Calculated)	00	CA	✓	X
30205	103	VL 3 - 1 (Calculated)	00	CC	✓	X
30225	113	-	00	E0	✓	X
30227	114	Run Hour (Utility)	00	E2	✓	✓
30229	115	On Hour (Utility)	00	E4	✓	✓

Table 4 : Continued...

Address (Register)	Parameter No.	Parameter	Modbus Start Address Hex		3P 4W	3P 3W
			High Byte	Low Byte		
30231	116	No. Of Interrupts (Utility)	00	E6	✓	✓
30233	117	Wh(Generator)	00	E8	✓	✓
30235	118	VAh(Generator)	00	EA	✓	✓
30237	119	Run Hour (Generator)	00	EC	✓	✓
30239	120	On Hour (Generator)	00	EE	✓	✓
30241	121	No. Of Interrupts (Generator)	00	F0	✓	✓
30243	122	Total Run Hour	00	F2	✓	✓
30245	123	Total On Hour	00	F4	✓	✓
30247	124	Old kWh (Utility)	00	F6	✓	✓
30249	125	Old kWh (Generator)	00	F8	✓	✓
30251	126	Old Run Hour (Utility)	00	FA	✓	✓
30253	127	Old Run Hour (Generator)	00	FC	✓	✓
30255	128	Old On Hour (Utility)	00	FE	✓	✓
30257	129	Old On Hour (Generator)	01	00	✓	✓
30259	130	Old Total Run Hour (Generator)	01	02	✓	✓
30261	131	Old Total On Hour	01	04	✓	✓
30263	132	Old No. Of Interruption (Utility)	01	06	✓	✓
30265	133	Old No. Of Interruption (Geneator)	01	08	✓	✓

Note : Parameters 1,2,3 are L-N Voltage for 3P 4W & L-L Voltage for 3P 3W .

Note : Active Energy reading received will be in Watt Hours.

Note : Apparent Energy reading received will be in VA Hours.

Accessing 4 X register for Reading & Writing :

Each setting is held in the 4X registers .ModBus code 03 is used to read the current setting and code 16 is used to write/change the setting. Refer Table 5 for 4 X Register addresses.

Example : Reading System type

System type : Start address= 0A (Hex) Number of registers = 02

Note :Number of registers= Number of Parameters x 2

Query :

Device Address	01 (Hex)
Function Code	03 (Hex)
Start Address High	00 (Hex)
Start Address Low	0A (Hex)
Number of Registers Hi	00 (Hex)
Number of Registers Lo	02 (Hex)
CRC Low	E4 (Hex)
CRC High	09 (Hex)

Start Address High : Most significant 8 bits of starting address of the parameter requested.

Start Address low :Least significant 8 bits of starting address of the parameter requested.

Number of register Hi : Most significant 8 bits of Number of registers requested.

Number of register Lo : Least significant 8 bits of Number of registers requested.

(Note : Two consecutive 16 bit register represent one parameter.)

Response: System Type (3phase 4 wire = 3)

Device Address	01 (Hex)
Function Code	03 (Hex)
Byte Count	04 (Hex)
Data Register1 High Byte	40 (Hex)
Data Register1Low Byte	40 (Hex)
Data Register2 High Byte	00 (Hex)
Data Register2 Low Byte	00(Hex)
CRC Low	EE (Hex)
CRC High	27 (Hex)

Byte Count : Total number of data bytes received.

Data register 1 High Byte : Most significant 8 bits of Data register 1 of the parameter requested.

Data register 1 Low Byte : Least significant 8 bits of Data register 1 of the parameter requested.

Data register 2 High Byte : Most significant 8 bits of Data register 2 of the parameter requested.

Data register 2 Low Byte : Least significant 8 bits of Data register 2 of the parameter requested.

(Note : Two consecutive 16 bit register represent one parameter.)

Example : Writing System type

System type : Start address= 0A (Hex) Number of registers = 02

Query:(Change System type to 3phase 3wire = 2)

Device Address	01 (Hex)
Function Code	10 (Hex)
Starting Address Hi	00 (Hex)
Starting Address Lo	0A(Hex)
Number of Registers Hi	00 (Hex)
Number of Registers Lo	02(Hex)
Byte Count	04 (Hex)
Data Register-1High Byte	40 (Hex)
Data Register-1 Low Byte	00(Hex)
Data Register-2 High Byte	00(Hex)
Data Register-2 Low Byte	00(Hex)
CRC Low	66 (Hex)
CRC High	10 (Hex)

Byte Count : Total number of data bytes to be transmitted.

Data register 1 High Byte : Most significant 8 bits of Data register 1 of the parameter requested.

Data register 1 Low Byte : Least significant 8 bits of Data register 1 of the parameter requested.

Data register 2 High Byte : Most significant 8 bits of Data register 2 of the parameter requested.

Data register 2 Low Byte : Least significant 8 bits of Data register 2 of the parameter requested.

(Note : Two consecutive 16 bit register represent one parameter.)

Response:

Device Address	01 (Hex)
Function Code	10 (Hex)
Start Address High	00 (Hex)
Start Address Low	0A(Hex)
Number of Registers Hi	00 (Hex)
Number of Registers Lo	02(Hex)
CRC Low	61 (Hex)
CRC High	CA (Hex)

Start Address High : Most significant 8 bits of starting address of the parameter requested.

Start Address low :Least significant 8 bits of starting address of the parameter requested.

Number of register Hi : Most significant 8 bits of Number of registers requested.

Number of register Lo : Least significant 8 bits of Number of registers requested.

(Note : Two consecutive 16 bit register represent one parameter.)

Table 5 : 4 X register addresses

Address (Register)	Parameter No.	Parameter	Read / Write	Modbus Start Address Hex	
				High Byte	Low Byte
40005	1	Energy Display on Modbus	R/Wp	00	04
40007	2	Sys Voltage	R	00	06
40009	3	Sys Current	R	00	08
40011	4	Sys Type	R/Wp	00	0A
40013	5	Pulse Width	R/Wp	00	0C
40015	6	Energy Reset	Wp	00	0E
40017	7	Run/On Hour & Interruption Reset	Wp	00	10
40019	8	RS 485 Set-up Code	R/Wp	00	12
40021	9	Node Address.	R/Wp	00	14
40023	10	Pulse Divisor	R/Wp	00	16
40033	11	PT Primary	R/Wp	00	20
40035	12	CT Primary	R/Wp	00	22
40037	13	System Power	R	00	24
40039	14	Energy Digit Rollover(reset) count	R/Wp	00	26
40041	15	Register Order/Word Order	R/Wp	00	28
40045	16	PT Secondary	R/Wp	00	2C
40071	17	Password	R/W	00	46

Explanation for 4 X register :

Address	Parameter	Description
40005	Energy display on Modbus	This address is used to set energy display on modbus in Wh,KWh & MWh. Write one of the following value to this address. 1 = Energy in Wh. 2 = Energy in KWh. 3 = Energy in MWh.
40007	System Voltage	This address is read only and displays System Voltage
40009	System Current	This address is read only and displays System Current
40011	System Type	This address is used to set the System type. Write one of the following value to this address. 2 = 3 Phase 3 Wire 3 = 3 Phase 4 Wire. Writing any other value will return error .
40013	Pulse Width of Relay	This address is used to set pulse width of the Pulse output. Write one of the following values to this address: 60 : 60 ms 100 : 100 ms 200 : 200 ms Writing any other value will return error .
40015	Reset Energy Counter	This address is used to reset the Energy Counter. Write zero value to this register to reset the energy counter. Writing any other value will return an error.
40017	Run/On Hour & Interruption reset	This address is used to reset the Run/On hour & number of Interruption . Write zero value to this register to reset the Run/On hour & number of Interruption. Writing any other value will return an error.
40019	Rs485 Set-up Code	This address is used to set the baud rate, Parity, Number of stop bits. Refer to Table 6 for details.
40021	Node Address	This register address is used to set Device address between 1 to 247 .
40023	Pulse Divisor	This address is used to set pulse divisor of the Pulse output. Write one of the following values to this address: 1 : Divisor 1 10 : Divisor 10 100 : Divisor 100 1000 : Divisor 1000 & in KWh and MWh divisor will be 1 by default. Writing any other value will return an error.
40033	PT Primary	This address allows the user to set PT Primary value. The maximum settable value is 400kV (3p4w) / 692.8kV (3p3w) & also depends on the per phase 1000MVA Restriction of power combined with CT primary. PT primary value should be in terms of voltage for example to set 2kV send 2000V.
40035	CT Pimary	This address allows the user to set CT Primary value. The maximum settable value is 9999 & also depends on the per phase 1000MVA Restriction of power combined with PT primary
40037	Sys Power	System Power (Read Only) is the Nominal system power based on the values of Nominal system volts and Nominal system current.
40039	Energy digit Rollover(Reset) Count	This address is used to setting maximum energy count after which energy will rollback to zero depends upon setting of Wh,KWh, & MWh.If Energy display on modbus in Wh count will be set in between 7 to 14 or In KWh set in between 7 to 12 & In MWh set in
40041	Word Order	Word Order controls the order in which EM 3490 DS receives or sends floating - point numbers- normal or reversed register order . In normal mode, the two registers that make up a floating point numbers are sent most significant bytes first. In reversed register mode , the two registers that make up a floating point numbers are sent least significant bytes first. To set the mode, write the value '2141.0' into this register- the instrument will detect the order used to send this value and set that order for all ModBus transaction involving floating point numbers.
40045	PT secondary	This address is used to read and write the PT secondary value. Ref Table for the range of PT secondary settable values in Section 3.2.1.3

Address	Parameter	Description
40071	Password	This address is used to set & reset the password. Valid Range of Password can be set is 0000 - 9999 . 1) If password lock is present & if this location is read it will return zero . 2) If Password lock is absent & if this location is read it will return One . 3) If password lock is present & to disable this lock first send valid password to this location then write "0000" to this location 4) If password lock is present & to modify 4X parameter first send valid password to this location so that 4X parameter will be accessible for modification. 5) If for in any of the above case invalid password is send then meter will return exceptional error 2.

Table 6 : RS 485 Set-up Code

Baud Rate	Parity	Stop Bit	Decimal value
19200	NONE	01	12
19200	NONE	02	13
19200	EVEN	01	14
19200	ODD	01	15
9600	NONE	01	08
9600	NONE	02	09
9600	EVEN	01	10
9600	ODD	01	11
4800	NONE	01	04
4800	NONE	02	05
4800	EVEN	01	06
4800	ODD	01	07
2400	NONE	01	00
2400	NONE	02	01
2400	EVEN	01	02
2400	ODD	01	03

NOTE :
Codes not listed in the table above may give rise to unpredictable results including loss of communication. Excise caution when attempting to change mode via direct Modbus writes.

5.1 User Assignable Modbus Registers:

The EM 3490DS contains the 20 user assignable registers in the address range of 0x200 (30513) to 0x226 (30551) (see Table 9). Any of the parameter addresses (3X register addresses Table 4)) accessible in the instrument can be mapped to these 20 user assignable registers. Parameters (3X registers addresses) that resides in different locations may be accessed by the single request by re-mapping them to adjacent address in the user assignable registers area. The actual address of the parameters (3X registers addresses) which are to be accessed via address 0x200 to 0x226 are specified in 4x Register 0x200 to 0x213 (see Table 10).

Table 9 : User Assignable 3X Data Registers

Address (Register)	Parameter Number.	Assignable Register	Modbus Start Address (Hex)	
			High Byte	Low Byte
30513	257	Assignable Reg 1	02	00
30515	258	Assignable Reg 2	02	02
30517	259	Assignable Reg 3	02	04
30519	260	Assignable Reg 4	02	06
30521	261	Assignable Reg 5	02	08
30523	262	Assignable Reg 6	02	0A
30525	263	Assignable Reg 7	02	0C
30527	264	Assignable Reg 8	02	0E
30529	265	Assignable Reg 9	02	10
30531	266	Assignable Reg 10	02	12
30533	267	Assignable Reg 11	02	14
30535	268	Assignable Reg 12	02	16
30537	269	Assignable Reg 13	02	18
30539	270	Assignable Reg 14	02	1A
30541	271	Assignable Reg 15	02	1C
30543	272	Assignable Reg 16	02	1E
30545	273	Assignable Reg 17	02	20
30547	274	Assignable Reg 18	02	22
30549	275	Assignable Reg 19	02	24
30551	276	Assignable Reg 20	02	26

Table 10 : User Assignable mapping register (4X registers)

Address (Register)	Parameter Number.	Mapping Register	Modbus Start Address (Hex)	
			High Byte	Low Byte
40513	257	Mapped Add for register #0x0200	02	00
40514	258	Mapped Add for register #0x0202	02	01
40515	259	Mapped Add for register #0x0204	02	02
40516	260	Mapped Add for register #0x0206	02	03
40517	261	Mapped Add for register #0x0208	02	04
40518	262	Mapped Add for register #0x020A	02	05
40519	263	Mapped Add for register #0x020C	02	06
40520	264	Mapped Add for register #0x020E	02	07
40521	265	Mapped Add for register #0x0210	02	08
40522	266	Mapped Add for register #0x0212	02	09
40523	267	Mapped Add for register #0x0214	02	0A
40524	268	Mapped Add for register #0x0216	02	0B
40527	269	Mapped Add for register #0x0218	02	0C
40528	270	Mapped Add for register #0x021A	02	0D
40529	271	Mapped Add for register #0x021C	02	0E
40530	272	Mapped Add for register #0x021E	02	0F
40531	273	Mapped Add for register #0x0220	02	10
40532	274	Mapped Add for register #0x0222	02	11
40533	275	Mapped Add for register #0x0224	02	12
40534	276	Mapped Add for register #0x0226	02	13

Example :

Assigning parameter to user assignable registers

To access the voltage2 (3X address 0x0002) and Power Factor1 (3X address 0x001E) through user assignable register assign these addresses to 4x register (Table 10) 0x0200 and 0x0201 respectively .

Assigning Query :

Device Address	01 (Hex)
Function Code	10 (Hex)
Starting Address Hi	02 (Hex)
Starting Address Lo	00 (Hex)
Number of Registers Hi	00 (Hex)*
Number of Registers Lo	02(Hex)*
Byte Count	04 (Hex)
Data Register-1High Byte	00 (Hex)
Data Register-1 Low Byte	02 (Hex)
Data Register-2 High Byte	00 (Hex)
Data Register-2 Low Byte	1E (Hex)
CRC Low	CB (Hex)
CRC High	07 (Hex)

Voltage 2 * (3X Address 0x0002)
Power Factor 1 * (3X Address 0x001E)

* Note : Parameters should be assigned in Multiple of two i.e. 2,4,6,8.....20.

Response :

Device Address	01 (Hex)
Function Code	10 (Hex)
Start Address High	02 (Hex)
Start Address Low	00 (Hex)
Number of Registers Hi	00 (Hex)
Number of Registers Lo	02 (Hex)
CRC Low	40 (Hex)
CRC High	70 (Hex)

Reading Parameter data through User Assignable Registers:

In assigning query Voltage2 and Power Factor1 parameters were assigned to 0x200 and 0x201(Table10) which will point to user assignable 3xregisters 0x200 and 0x202 (table9). So to read Voltage2 and PowerFactor1 data reading query should be as below.

Query:

Device Address	01 (Hex)
Function Code	04 (Hex)
Start Address High	02 (Hex)
Start Address Low	00 (Hex)
Number of Registers Hi	00 (Hex)
Number of Registers Lo	04 (Hex) **
CRC Low	F0 (Hex)
CRC High	71 (Hex)

Start Address High : Most significant 8 bits of starting address of User assignable register.

Start Address low :Least significant 8 bits of starting address of User assignable register.

Number of register Hi : Most significant 8 bits of Number of registers requested.

Number of register Lo : Least significant 8 bits of Number of registers requested.

****Note : Two consecutive 16 bit register represent one parameter. Since two parameters are requested four registers are required**

Response : (Volt2 = 219.30 / Power Factor1 = 1.0)

Device Address	01 (Hex)
Function Code	04 (Hex)
Byte count	08 (Hex)
Data Register-1High Byte	43 (Hex)
Data Register-1 Low Byte	5B (Hex)
Data Register-2 High Byte	4E (Hex)
Data Register-2 Low Byte	04 (Hex)
Data Register-3 High Byte	3F (Hex)
Data Register-3 Low Byte	80 (Hex)
Data Register-4 High Byte	00 (Hex)
Data Register-4 Low Byte	00 (Hex)
CRC Low	79 (Hex)
CRC High	3F (Hex)

Voltage 2 Data
Power Factor 1Data

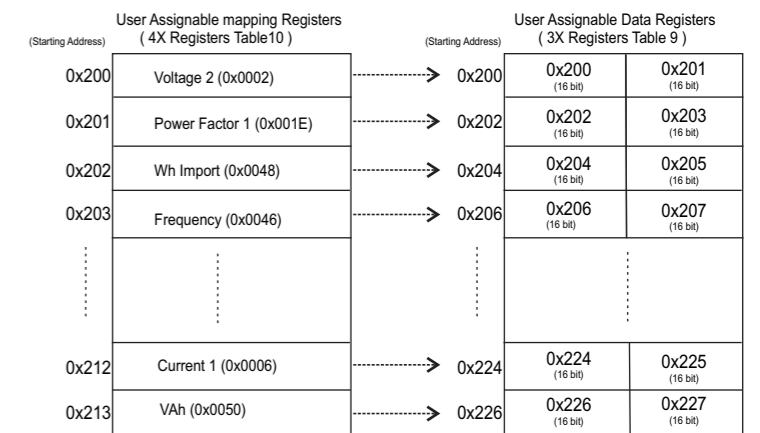

To get the data through User assignable Register use following steps:

- 1) Assign starting addresses (Table 3) of parameters of interest to a "User assignable mapping registers" in a sequence in which they are to be accessed (see section "Assigning parameter to user assignable registers")
- 2) Once the parameters are mapped data can be acquired by using "User assignable data register" Starting address . i.e to access data of Voltage2, Power factor1, Wh import, Frequency send query with starting address 0x200 with number of register 8 or individually parameters can be accessed for example if current1 to be accessed use starting address 0x212. (See section Reading Parameter data through User Assignable Registers)

6. Phasor Diagram :

Quadrant 1: 0° to 90°
 Quadrant 2: 90° to 180°
 Quadrant 3: 180° to 270°
 Quadrant 4: 270° to 360°

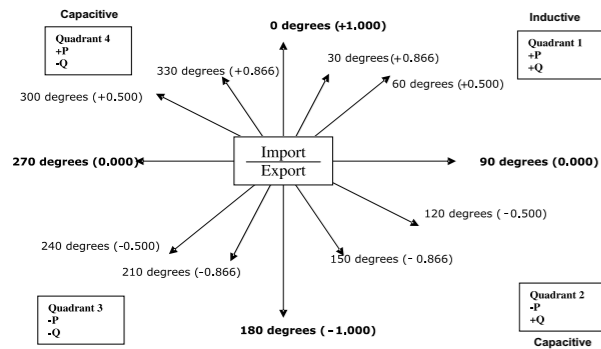

Connections	Quadrant	Sign of Active Power (P)	Sign of Reactive Power (Q)	Sign of Power Factor (PF)	Inductive / Capacitive
Import	1	+ P	+ Q	+	L
Import	4	+ P	- Q	+	C
Export	2	- P	+ Q	-	C
Export	3	- P	- Q	-	L

Inductive means Current lags Voltage
 Capacitive means Current leads Voltage

When EM 3490 DS displays Active power (P) with " + " (positive sign) , the connection is " **Import** " .

When EM 3490 DS displays Active power (P) with " - " (negative sign) , the connection is " **Export** " .

Note : Though EM 3490 DS displays Active power (P) with " + " (Positive sign) or " - " (negative sign) depending on External CT Connection, Energy (kWh) integration will be in done same register irrespective of Import or Export connection

7. Installation

Mounting is by four side clamps, slide the side clamps through side slot till side clamp gets firmly locked in a groove (Refer fig.) Consideration should be given to the space required behind the instrument to allow for bends in the connection cables.

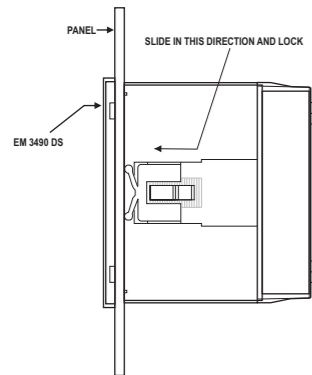

As the front of the enclosure conforms to IP54 it is protected from water spray from all directions, additional protection to the panel may be obtained by the use of an optional panel gasket. The terminals at the rear of the product should be protected from liquids.

The EM 3490 DS should be mounted in a reasonably stable ambient temperature and where the operating temperature is within the range -10 to 55°C . Vibration should be kept to a minimum and the product should not be mounted where it will be subjected to excessive direct sunlight.

Caution

- In the interest of safety and functionality this product must be installed by a qualified engineer, abiding by any local regulations.
- Voltages dangerous to human life are present at some of the terminal connections of this unit. Ensure that all supplies are de-energised before attempting any connection or disconnection.
- These products do not have internal fuses therefore external fuses must be used to ensure safety under fault conditions.

7.1 EMC Installation Requirements

This product has been designed to meet the certification of the EU directives when installed to a good code of practice for EMC in industrial environments, e.g.

- Screened output and low signal input leads or have provision for fitting RF suppression components, such as ferrite absorbers, line filters etc., in the event that RF fields cause problems.

Note: It is good practice to install sensitive electronic instruments that are performing critical functions, in EMC enclosures that protect against electrical interference which could cause a disturbance in function.

- Avoid routing leads alongside cables and products that are, or could be, a source of interference.

- To protect the product against permanent damage, surge transients must be limited to 2kV pk. It is good EMC practice to suppress differential surges to 2kV at the source. The unit has been designed to automatically recover in the event of a high level of transients. In extreme circumstances it may be necessary to temporarily disconnect the auxiliary supply for a period of greater than 5 seconds to restore correct operation. The Current inputs of these products are designed for connection in to systems via Current Transformers only, where one side is grounded.

- ESD precautions must be taken at all times when handling this product.

7.2 Case Dimension and Panel Cut Out

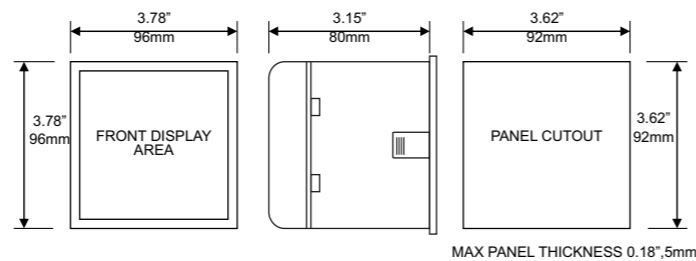

7.3 Wiring

Input connections are made directly to screw-type terminals with indirect wire pressure. Numbering is clearly marked in the plastic moulding. Choice of cable should meet local regulations. Terminal for both Current and Voltage inputs will accept upto 3mm² x 2 diameter cables.

Note : It is recommended to use wire with lug for connection with meter.

7.4 Auxiliary Supply

EM 3490 DS should ideally be powered from a dedicated supply, however it may be powered from the signal source, provided the source remains within the limits of the chosen auxiliary voltage.

7.5 Fusing

It is recommended that all voltage lines are fitted with 1 amp HRC fuses.

7.6 Earth/Ground Connections

For safety reasons, CT secondary connections should be grounded in accordance with local regulations.

8. Connection Diagram

8.1 Network Wiring

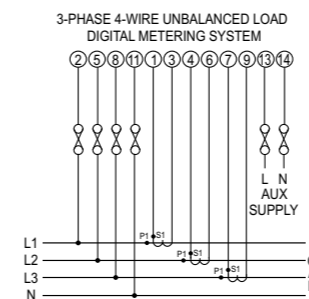
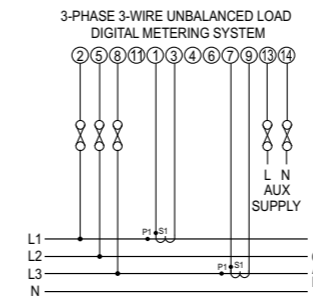

8.2 Generator Sense Connection Diagram

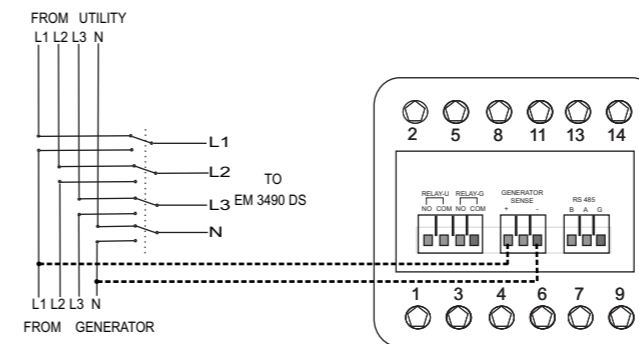

Generator Sense Voltages
 AC Voltage :- 20VAC to 300VAC
 DC Voltage :- 10VDC to 60VDC

9. Specification :

System

3 Phase 3 Wire / 4 Wire programmable at site

Inputs

Nominal input voltage (Three wire and Four wire) 57.7 V_{L-N} to 277V_{L-N} (100V_{L-L} to 480 V_{L-L})

Max continuous input voltage 120% of Rated Value

Max short duration input voltage 2 x Rated Value (1s application repeated 10 times at 10s intervals)

Nominal input voltage burden 0.2VA approx. per phase

Nominal input current 1A OR 5A AC rms

Starting Current 0.4% of Nominal Input Current

Max continuous input current 120% of Rated Value

Nominal input current burden 0.6VA approx. per phase

Max short duration current input 20 x Rated Value (1s application repeated 5 times at 5 min. intervals)

System CT primary values Std. Values upto 4kA (1 or 5 Amp secondaries)

Auxiliary

Standard nominal Auxillary supply voltages & Frequency 110V AC/50 Hz , 230V AC/50 Hz ,380V AC/50 Hz , 100 - 250V AC- DC, 12 - 48V DC

a.c. supply voltage tolerance +20 % / -15 % of Rated Value

a.c. supply frequency range 45 to 66 Hz

a.c. supply burden 4.5VA

d.c. supply burden 3W

Operating Measuring Ranges

Voltage 5 .. 120 % of Rated Value

Current 5 .. 120 % of Rated Value

Frequency 40 .. 70 Hz

Power Factor 0.5 Lag ... 1 ... 0.8 Lead

Accuracy

Voltage ± 0.5 % of range (50 ... 100% of Rated Value)

Current ± 0.5 % of range (10 ... 100% of Rated Value)

Frequency 0.15% of mid frequency

Active Power ± 0.5 % of range (10 ... 100% of Rated Value)

Re- Active Power ± 0.5 % of range (10 ... 100% of Rated Value)

Apparent Power ± 0.5 % of range (10 ... 100% of Rated Value)

Active Energy ± 1 % as per IEC 62053-21
 Active P.F. (0.5 lag ... 1 ... 0.8 lead)

Apparant Energy ± 1 %

Power Factor ± 1 % of Unity

Angle ± 1 % of range

Reference conditions for Accuracy :

Reference temperature 23°C ± 2°C

Input frequency 50 or 60Hz ± 2%

Input waveform Sinusoidal (distortion factor 0.005)

Auxiliary supply voltage Rated Value ± 1 %

Auxiliary supply frequency Rated Value ± 1 %

Power Factor 0.5 lag 1 0.8 lead

Nominal range of use of influence quantities for measurands

Voltage	50 .. 120 % of Rated Value
Current	10 .. 120 % of Rated Value
Input frequency	Rated Value \pm 10 %
Temperature	0 to 50°C
Auxiliary supply voltage	Rated Value \pm 10 %
Auxiliary supply frequency	Rated Value \pm 10 %
Temperature Coefficient (For Rated value range of use 0... 50°C)	0.025% /°C for Voltage (50..120% of Rated Value) 0.05% /°C for Current (10..120% of Rated Value)
Error change due to variation of an influence quantity	2 * Error allowed for the reference condition applied in the test.

Display

LED	2 line 7 digits .
Update	Approx. 1 seconds

Controls

User Interface	Two push buttons
----------------	------------------

Standards

EMC Immunity	IEC 61326 10V/m min-Level 3 industrial low level electromagnetic radiation environment IEC 61000-4-3.
Safety	IEC 61010-1 , Year 2001
IP for water & dust	IEC 60529

Isolation

Dielectric voltage withstand test between circuits and accessible surfaces	2.2 kV RMS 50 Hz for 1 minute between all electrical circuits
--	--

Environmental

Operating temperature	-10 to 55 °C
Storage temperature	-20 to +65°C
Relative humidity	0 .. 90 % RH
Warm up time	3 minute (minimum)
Shock	15g in 3 planes
Vibration	10 .. 55 Hz, 0.15mm amplitude
Enclosure (front only)	IP 54 as per IEC 60529

Enclosure

Style	96mm x 96mm DIN Quadratic
Material	Polycarbonate Housing , Self extinguish & non dripping as per UL 94 V-0
Terminals	Screw-type terminals
Depth	< 80 mm
Weight	0.620 kg Approx.

ModBus (RS 485) Option :

Protocol	ModBus (RS 485)
Baud Rate	19200 , 9600 , 4800 or 2400 (Programmable)
Parity	Odd or Even, with 1 stop bit, Or None with 1 or 2 stop bits

Notes :

Notes :

10. Connection for Optional Pulse Output / RS 485

10.1 Two Pulse Output

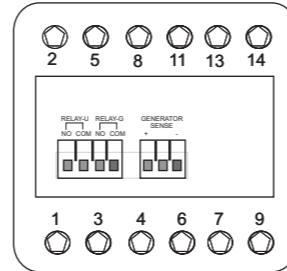

10.2. RS 485 Output

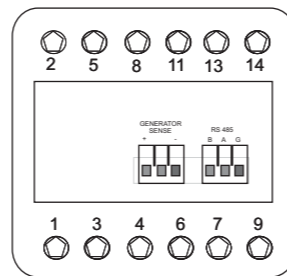

10.3. Two Pulse (Two Limit) + RS 485 Output

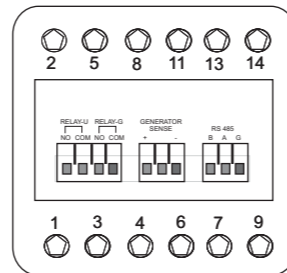

The information contained in these installation instructions is for use only by installers trained to make electrical power installations and is intended to describe the correct method of installation for this product. However, organization has no control over the field conditions which influence product installation. It is the user's responsibility to determine the suitability of the installation method in the user's field conditions. organization only obligations are those in organization standard Conditions of Sale for this product and in no case will organization be liable for any other incidental, indirect or consequential damages arising from the use or misuse of the products.