

Operating Manual

RISH EM DC 6000



DIGITAL MULTIFUNCTION INSTRUMENT

Programmable Multi-function DC Energy Meter

Installation & Operating Instructions

Section	Contents
1.	Introduction
2.	Measurement Reading Screens
	2.1 Timer Screen
	2.2 Number of Interruptions
	2.3 On-hour
	2.4 Run-hour
	2.5 Date and time
3.	Installation
	3.1 EMC installation requirements
	3.2 Case Dimensions and Panel Cut-out
	3.3 Wiring
	3.4 Auxiliary Supply
	3.5 Fusing
	3.6 Earth/Ground Connections
	3.7 Optional Pluggable (Addon) Module
4.	Connection Diagram
	4.1 Connection for Optional Relay Output / RS 485 / USB
	4.1.1 RS 485 Output with Relay1 & Relay2
	4.1.2 USB and RS 485 Output with Relay1 & Relay2
5.	Parameter Editing Guide
6.	Setup Screens (Flow Chart)
7.	Programming
	7.1 Password Protection
	7.2 System Parameter Selection Screen
	7.2.1 Auto Voltage Detection
	7.2.2 Nominal Voltage
	7.2.3 Current Full Scale value
	7.2.4 Current Shunt value
	7.2.5 Demand Integration Time
	7.2.6 Energy Rate

- 7.2.7 Reverse Locking
- 7.2.8 Auto Scrolling
- 7.2.9 Noise Current
- 7.2.10 Energy Output
- 7.2.11 Energy Digit Reset Count
- 7.3 Communication Parameter Selection Screen
 - 7.3.1 Address Setting
 - 7.3.2 Baud rate
 - 7.3.3 Parity selection
- 7.4 Reset Parameter Selection Screen
- 7.5 Output Option selection Screen
 - 7.5.1 Select Relay Output
 - 7.5.1.1 Limit Relay Configuration
 - 7.5.1.1.1 Limit Parameter
 - 7.5.1.1.2 Limit Configuration
 - 7.5.1.1.3 Trip Point
 - 7.5.1.1.4 Hysteresis
 - 7.5.1.1.5 Energising Delay
 - 7.5.1.1.6 De-energising Delay
 - 7.5.1.2 Pulse Relay Configuration
 - 7.5.1.2.1 Pulse Parameter
 - 7.5.1.2.2 Pulse Divisor
 - 7.5.1.2.3 Pulse Duration
 - 7.5.1.3 Timer Relay Configuration
 - 7.5.1.3.1 Number of Cycles
 - 7.5.1.3.2 Timer Configuration
 - 7.5.1.3.3 On Delay
 - 7.5.1.3.4 Off Delay
 - 7.5.1.4 Remote Operation
 - 7.5.1.5 Reverse Locking Relay
 - 7.5.1.5.1 Relay Configuration
 - 7.5.1.5.2 On Delay
 - 7.5.1.5.3 Off Delay

- 7.5.1.6 RTC Relay
 - 7.5.1.6.1 Weekdays Selection
 - 7.5.1.6.2 Relay Configuration
 - 7.5.1.6.3 On Time
 - 7.5.1.6.4 Off Time
- 7.6 RTC Setup Selection Screen
 - 7.6.1 RTC Date Setup
 - 7.6.2 RTC Time Setup
- 7.7 Datalog Setup Selection Screen
 - 7.7.1 Event Datalog Setup
 - 7.7.1.1 Event Datalog Start/Stop
 - 7.7.2 Time Datalog Setup
 - 7.7.2.1 Time Datalog Start/Stop
 - 7.7.2.2 Interval Selection
 - 7.7.2.3 Parameter Count
 - 7.7.2.4 Parameter Selection
 - 7.7.3 Load Profile Setup
 - 7.7.3.1 Load Profile Datalog Start/Stop
- 7.8 User Assignable screens Setup
 - 7.8.1 No. of User Screens
 - 7.8.1.1 User Screen no. Selection
- 7.9 Factory Reset Selection Screen
 - 7.9.1 Factory Reset Confirmation
- 8. Relay Output
 - 8.1 Limit Relay
 - 8.2 Pulse Output
 - 8.3 Timer Output
- 9. Specification

1. Introduction

The Multifunction DC Energy Meter is a panel mounted 96 x 96 mm DIN Quadratic Digital Panel Meter, which measures important electrical parameters in DC Network and replaces the multiple analog panel meters. It measures electrical parameters like DC voltage, Current, Power, Energy (Import & Export), Demand & many more. The meter integrates accurate measurement technology with bright LED display (8 digit x 1).

The meter can be configured on site for various parameters including Nominal Voltage, Current Full scale Setting, Current Shunt Settings, Demand Integration Time, etc.

The front panel has three push buttons using which the user can scroll through different screens & configure the product. It also includes 12 LEDs which in conjunction with LED display, provides information in different units and gives the status.

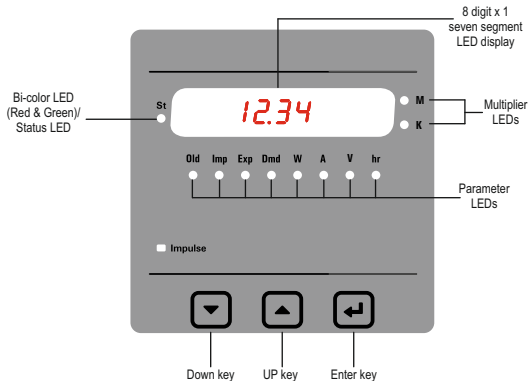

The Status LED serves many purposes. In measurement screens, it changes color according to load status i.e. healthy, alarm and overload conditions. Overload condition is defined as measured value > 126% of nominal value. Refer the following points to decode the information that the LED provides.

These points are true for measured parameters i.e. voltage and current.

- The Status LED glows green in healthy condition and becomes red in overload condition.
- If a limit relay is assigned, the LED will glow red if alarm condition is true and will glow green if healthy condition is observed.

For derived parameters (power, energy, ampere-hour and demand), following points are applicable.

- When the voltage and current both are healthy, the Status LED will glow green. If one of the parameters (voltage or current) is in overload condition, Status LED for all the derived parameter calculated from that value will also turn red.
- If a limit is assigned to the parameter, the Status LED will glow red in alarm condition and green in healthy condition.

When more than one from the above conditions are applicable, the Status LED will follow "OR" logic for alarm condition and "AND" logic for healthy condition, i.e. it will glow red when even one of the alarm conditions is true and it will only glow green when all of the healthy conditions are true.

There are two multiplier LEDs marked K (kilo: 10^3) and M (mega: 10^6). Each will glow red according to the scaling required to the value on display.

One or more from the parameter LEDs will glow red according to the parameter displayed on the screen.

2. Measurement Reading Screens

In normal operation, the meter shows one of the measurement reading screens out of several screens. These screens may be scrolled through one at a time in incremental order by pressing the "UP key" or in decremental order by pressing the "DOWN key".



An example of the current screen is shown in above pictures.

As shown in screen 1 the Status LED is glowing green which means it is in healthy condition.

The Status LED glowing red with -OL- displayed on screen which means that the measured current is above 126% of nominal value set. (As shown in screen 2)



An example of the power screen is shown in the picture.

The Status LED is glowing green which means it is in healthy condition. (As shown in screen 1)

The Status LED is glowing red and a measured value is being displayed, which means one from the following conditions is present. (As shown in screen 2)

- 1) There is a limit relay and alarm condition is present.
- 2) Any one from voltage or current is in overload condition.



Import Energy Screen



Import Energy Overflow Screen

Shown above screens are the import energy screens. The display of the meter can only accommodate 8 digits. So to display more than 8 digit energy, an overflow screen is added.

When the energy reaches the energy digit reset count, it starts the count from 0 again. When this happens the corresponding overflow is increased by 1.

The maximum value of the overflow is 2000. Thus the highest energy that the meter can show is 200099999999 Mwh.

To obtain the value for current energy reading, the user need to multiply the overflow count by 10 raised to energy digit reset count and add the result in displayed energy reading.

Example: In the screens shown above, assume that the energy digit reset count is 8 respectively. So the energy reading will be as following:

$$[(100 \times 10^8) + 5030] = 10000005030 \text{ Wh}$$

The overflow value will start counting from 0 after reaching 2000.

Note - DC EM measures positive & negative Voltage, Current and it's derived parameters.

2.1 Timer Screen

Number of cycles -

Parameter Name



Toggles every 3 Sec

Parameter Value

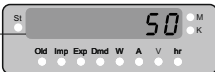

On Delay -

Parameter Name



Toggles every 3 Sec

Parameter Value

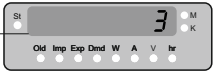

Off Delay -

Parameter Name



Toggles every 3 Sec

Parameter Value

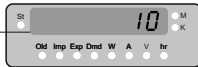

There are two timers : tMr1 and tMr2. Each separate screens for the three parameters of each timer namely, number of cycles, on delay and off delay present in measurement screens are shown in above pictures. Each parameter screen toggles between its parameter name and its parameter value every 3 seconds.

When timer is running, these values are shown in countdown mode. If number of cycles is set as 0, then the number of cycles will always increment from 0 up to 9999.

Note : - 1. Long press UP key to start any timer.

2. Long press down key to stop any timer.

Timer Unused : - Timer is not selected as a relay output.

2.2 Number of Interruptions

This screen shows the number of power supply interruptions that the meter has encountered. After 9999 this value will start it's count from 0. User can reset this count in the reset menu. This screen toggles between its parameter name & its parameter value every 3 sec.

Parameter Name



Toggles every 3 Sec

Parameter Value



2.3 On-hour



This screen shows the total number of hours the auxiliary supply has stayed on. Even if the Auxiliary supply is interrupted count of on hour will be maintained in internal memory & displayed in the "hhhhhh.mm" format. For example if displayed count is 105000.10 it indicates 105000 hours and 10 minutes. After 999999.59 On hours display will restart from zero. The user can reset this value in reset parameters menu As shown above the parameter screen toggles between its parameter name & its parameter value every 3 seconds..

2.4 Run Hour

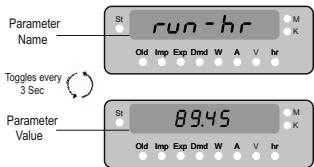

This Screen shows the total no. of hours load has been connected. Even if the Auxiliary supply is interrupted, count of Run hour will be maintained in internal memory & displayed in the format "hhhhhh.mm".

For example if Displayed count is 105000.10 it indicates 105000 hours & 10 minutes. After 999999.59 run hours display will restart from zero. The user can reset these values in reset parameters menu.

As shown above the parameter screen toggles between its parameter name & its parameter value every 3 seconds.

2.5 Date and Time

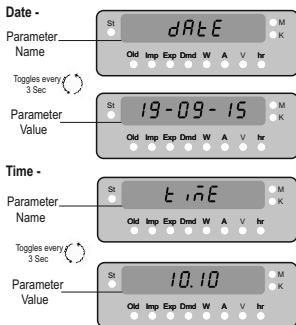

The above screens show two parameters the RTC date and time in dd-mm-yy and hh.mm format respectively. Both parameter screen toggles between its parameter name and its parameter value every 3 seconds.

The user can change these values in RTC setup menu.

Table-1

Measured Parameter	Min	Max	Measuring range	Displaying range	Accuracy
Voltage	●	●	±10~ ±60VDC ±61~ ±200 VDC ±201~± 1000VDC	0 - ±9999	± 0.5% of nominal value
Current	●	●	50~ 150mV	0 - ±9999	±0.5 % of nominal value
Power (Import & Export)			0 - ±1.2MW 0 - ±4.0MW 0 - ±20 MW	0 - ±9999	±0.5 % of nominal value (±0.5 to ±120%)
Energy (Import & Export)			0-99999999	0-99999999	Class 0.5
Ampere Hour (Import & Export)			0-99999999	0-99999999	-
Demand (Import & Export)		●	0 - ± 1.2MW 0 - ± 4 MW 0 - ±20MW	0 - 9999	-
Current Demand (Import & Export)		●	50~ 150mV	0 - 9999	-
On Hour			0 - 999999.59	0 - 999999.59	-
Run Hour			0 - 999999.59	0 - 999999.59	-
Number of Interruptions			0-9999	0- 9999	-

TABLE : 2 Measurement Screen Parameters

Screen No.	Screen Name	Parameter LED Status
1	Voltage	V
2	Current	A
3	Power	W
4	Import Energy	Imp,W,hr
5	Import Energy OF	Imp,W,hr
6	Export Energy	Exp,W,hr
7	Export Energy OF	Exp,W,hr
8	Import Ampere Hour	Imp,A,hr
9	Import Ampere Hour OF	Imp,A,hr
10	Export Ampere Hour	Exp,A,hr
11	Export Ampere Hour OF	Exp,A,hr
12	Import Power Demand	Imp,W,Dm
13	Export Power Demand	Exp,W,Dm
14	Import Current Demand	Imp,A,Dm
15	Export Current Demand	Exp,A,Dm
16	On - hrs	None
17	Run - hrs	None
18	Max Voltage	V
19	Min Voltage	V
20	Max Current	A
21	Min Current	A
22	Import Max Power Demand	Imp,W,Dm
23	Export Max Power Demand	Exp,W,Dm
24	Import Max Current Demand	Imp,A,Dm
25	Export Max Current Demand	Exp,A,Dm
26	No of interruptions	None
27	Old Import Energy	Old, Imp, W, hr
28	Old Import Energy OF	Old, Imp, W, hr
29	Old Export Energy	Old, Exp, W, hr
30	Old Export Energy OF	Old, Exp, W, hr

Continued...

Screen No.	Screen Name	Parameter LED Status
31	Old Import Amp Hour	Old, A, hr, Imp
32	Old Import Amp Hour OF	Old, A, hr, Imp
33	Old Export Amp Hour	Old, A, hr, Exp
34	Old Export Amp Hour OF	Old, A, hr, Exp
35	Old Max Import Power Demand	Old, W, Dm, Imp
36	Old Max Export Power Demand	Old, W, Dm, Exp
37	Old Max Import Current Demand	Old, A, Dm, Imp
38	Old Max Export Current Demand	Old, A, Dm, Exp
39	Old No. of interruptions	Old
40	Old On Hour	Old
41	Old Run Hour	Old
42 ¹	Timer 1 Number of Cycles	None
43 ¹	Timer 1 On Delay	None
44 ¹	Timer 1 Off Delay	None
45 ¹	Timer 2 Number of Cycles	None
46 ¹	Timer 2 On Delay	None
47 ¹	Timer 2 Off Delay	None
48 ²	RTC Complete Date	None
49 ²	RTC Complete Time	None

NOTE :

1. These screens will be available only with Relay Addon card.
2. These screens will be available only in the Datalogging variant.

TABLE : 3 Datalogging Parameters List

Parameter No.	Parameters
0	Voltage
1	Current
2	Power
3	Import Energy
4	Import Energy OF
5	Export Energy
6	Export Energy OF
7	Import Ampere Hour
8	Import Ampere Hour OF
9	Export Ampere Hour
10	Export Ampere Hour OF
11	Import Power Demand
12	Export Power Demand
13	Import Current Demand
14	Export Current Demand
15	Max Voltage
16	Min Voltage
17	Max Current
18	Min Current
19	Max Import Power Demand
20	Max Export Power Demand
21	Max Import Current Demand
22	Max Export Current Demand
23	Import Energy on update rate
24	Import Energy on update rate OF
25	Export Energy on update rate

Parameter No.	Parameters
26	Export Energy on update rate OF
27	On Hour
28	Run Hour
29	No of interruptions
30	Old Import Energy
31	Old Import Energy OF
32	Old Export Energy
33	Old Export Energy OF
34	Old Ampere Hour Imp
35	Old Ampere Hour Imp OF
36	Old Ampere Hour Exp
37	Old Ampere Hour Exp OF
38	Old Max Import Power Demand
39	Old Max Export Power Demand
40	Old Max Import Current Demand
41	Old Max Export Current Demand
42	Old On Hour
43	Old Run Hour
44	Old No of interruptions

3. Installation

Mounting of the Meter is featured with easy "Clip-in" mounting. Push the meter in panel slot (size 92 x92 mm), it will click fit into panel with the four integral retention clips on two sides of meter. If required, additional support is provided with swivel screws as shown in figure.

The front of the enclosure conforms to IP54. Additional protection to the panel may be obtained by the use of an Optional panel gasket. The terminals at the rear of the product should be protected from liquids.

The Meter should be mounted in a reasonably stable ambient temperature and where the operating temperature is within the range 0 to 50°C. Vibration should be kept to a minimum and the product should not be mounted where it will be subjected to excessive direct sunlight.

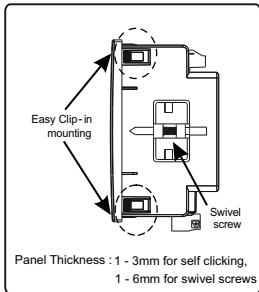

Caution

1. In the interest of safety and functionality of this product must be installed by a qualified engineer, abiding by any local regulations.
2. Voltages dangerous to human life are present at some of the terminal connections of this unit. Ensure that all supplies are de-energised before attempting any connection or disconnection.
3. These products do not have fuses, therefore external fuses must be used to ensure safety under fault conditions.

3.1 EMC Installation Requirements

This product has been designed to meet the certification of the EU directives when installed to a good code of practice for EMC in industrial environments, e.g.

1. Screened output and low signal input leads or have provision for fitting RF suppression components, such as ferrite absorbers, line filters etc., in the event that RF fields cause problems.

Note : It is good practice to install sensitive electronic instruments that are performing critical functions, in EMC enclosures that protect against electrical interference which could cause a disturbance in function.

2. Avoid routing leads alongside cables and products that are, or could be, a source of interference.

3. To protect the product against permanent damage, surge transients must be limited to 2kV pk. It is good EMC practice to suppress differential surges to 2kV at the source. The unit has been designed to automatically recover in the event of a high level of transients. In extreme circumstances it may be necessary to temporarily disconnect the auxiliary supply for a period of greater than 5 seconds to restore correct operation.

The Current inputs of these products are designed for connection to systems via shunt only

4. ESD precautions must be taken at all times when handling this product.

3.2 Case Dimensions and Panel Cut-Out

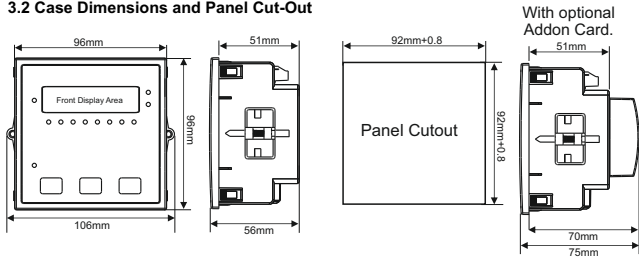

3.3 Wiring

Input connections are made directly to screw-type terminals with indirect wire pressure. Numbering is clearly marked on the connector. Choice of cable should meet local regulations. Terminals for both Current and Voltage inputs will accept upto 4mm^2 (12AWG) solid or 2.5mm^2 stranded cable.

Note: It is recommended to use wire with Pin type for connection with meter.

3.4 Auxiliary Supply

Meter should ideally be powered from a dedicated supply, however powered from the signal source, provided the source remains within it may be the limits of the Chosen auxiliary voltage range.

3.5 Fusing

It is recommended that all voltage lines are fitted with 1 Amp HRC fuses or circuit breaker to disconnecting the device.

3.6 Earth/Ground Connections

For safety reasons, ensure proper grounding of the panel in accordance with local regulations.

3.7. Optional Pluggable (Addon) Module

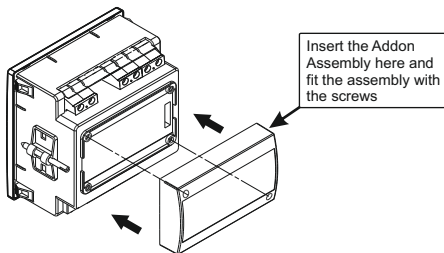

Optional Pluggable (Addon) Module

4. Connection Diagram

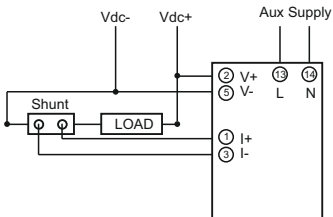

4.1.2. USB and RS 485 Output with Relay1 & Relay2

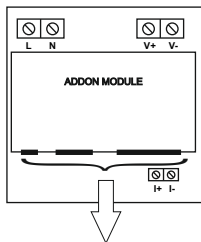

4.1. Connection for Optional Pulse Output / RS485 (Rear View of Multifunction Meter):

4.1.1. RS 485 Output with Relay1 & Relay2

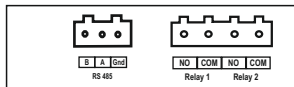
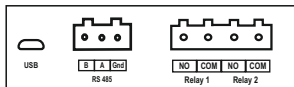
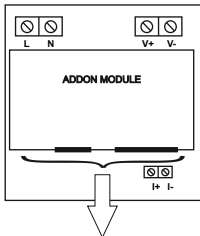

5. Parameter Editing Guide (Unless specified otherwise, follow these steps to edit any value in setup screens.)

- 1) Use **←** key to enter editing mode. A blinking decimal point will be displayed as cursor.
- 2) Use **▲** & **▼** keys to increase or decrease the digit values respectively, or cycle through options.
- 3) Use **←** key to go to the next cursor position.
- 4) Use **←** key to confirm the value and finish editing.
- 5) Longpress **▲** & **▼** together to go to the previous menu.
The same can be achieved by going to quit screen and pressing **←** key.
- 6) If user inputs values out of the limits specified, they are brought to the limit values automatically by the meter and shown at value confirmation. These limits are mentioned besides the corresponding screens on the flowchart starting from next page.
- 7) Any exceptions and special cases are also marked with * and explained on the bottom of the page.
- 8) Number of 'x's denote displayed digits on the screen which the user can edit.

There are two types of parameters in the setup screens. 1) Numeric & 2) Options.

Example 1: If a user want to change a numeric value he/she will have to follow the steps mentioned below.

Parameters having numeric value can be identified by the mentioned range parameter besides the corresponding screen in the flowchart. We'll take example of V-FS screen.

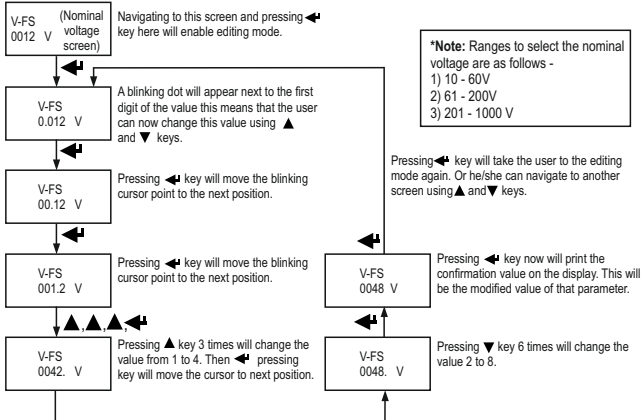

Example 2: If a user want to change a parameter with options he/she will have to follow the steps mentioned below. Parameters having options can be identified by the mentioned options parameter besides the corresponding screen in the flowchart. We'll take example of parity screen.

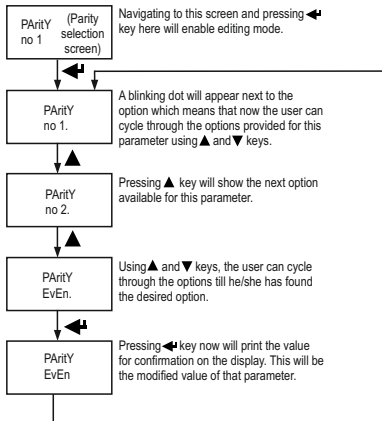

Navigating to this screen and pressing **←** key here will enable editing mode.

A blinking dot will appear next to the option which means that now the user can cycle through the options provided for this parameter using **▲** and **▼** keys.

Pressing **▲** key will show the next option available for this parameter.

Using **▲** and **▼** keys, the user can cycle through the options till he/she has found the desired option.

Pressing **←** key now will print the value for confirmation on the display. This will be the modified value of that parameter.

Pressing **←** key will take the user to the editing mode again. Or he/she can navigate to another screen using **▲** and **▼** keys.

6. Setup Screens (Flowchart)

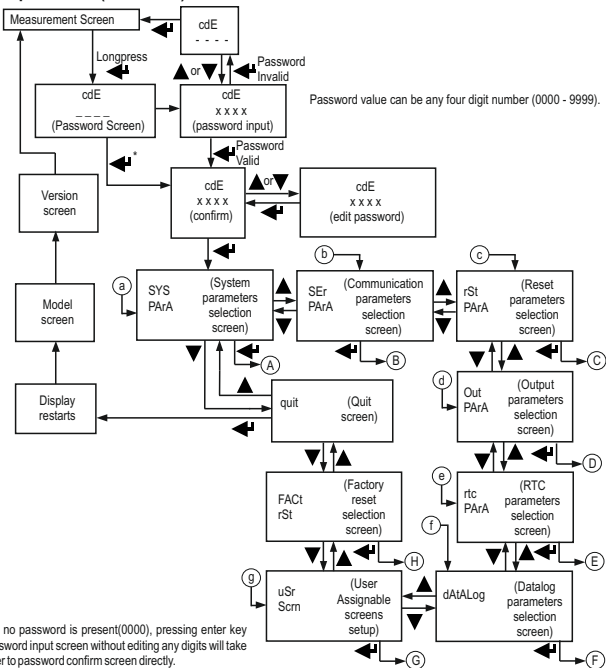

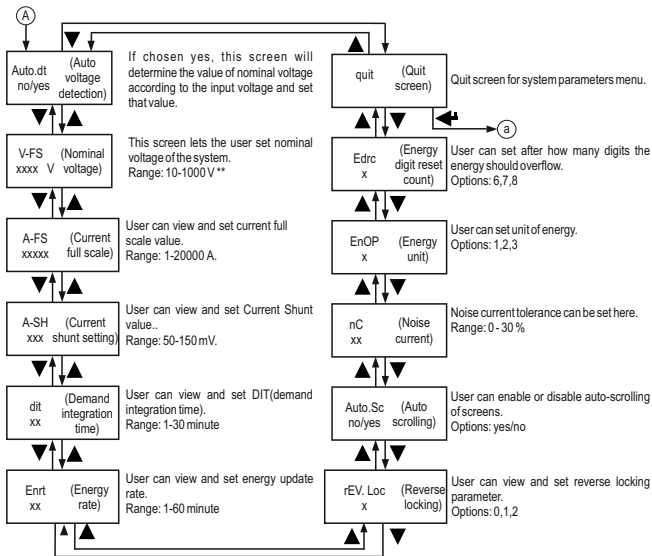

** Value changes according to the model. (10 - 60V, 61 - 200V, 201 - 1000V)

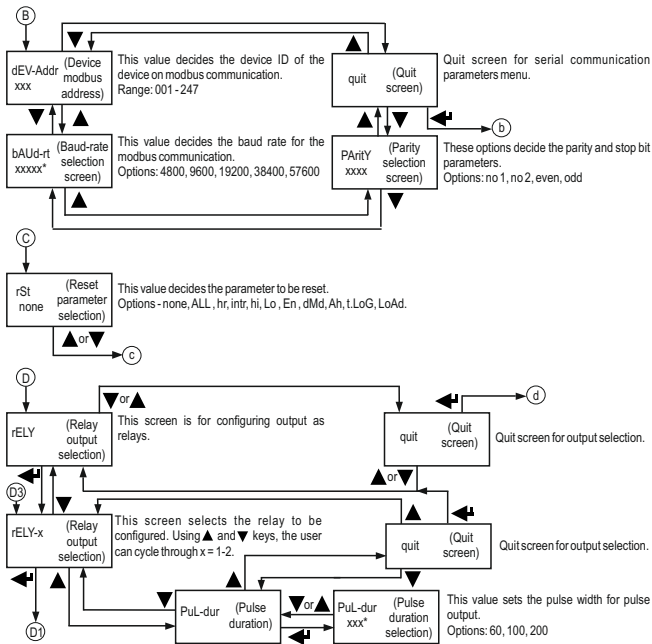

* These options have values with varying number of digits..

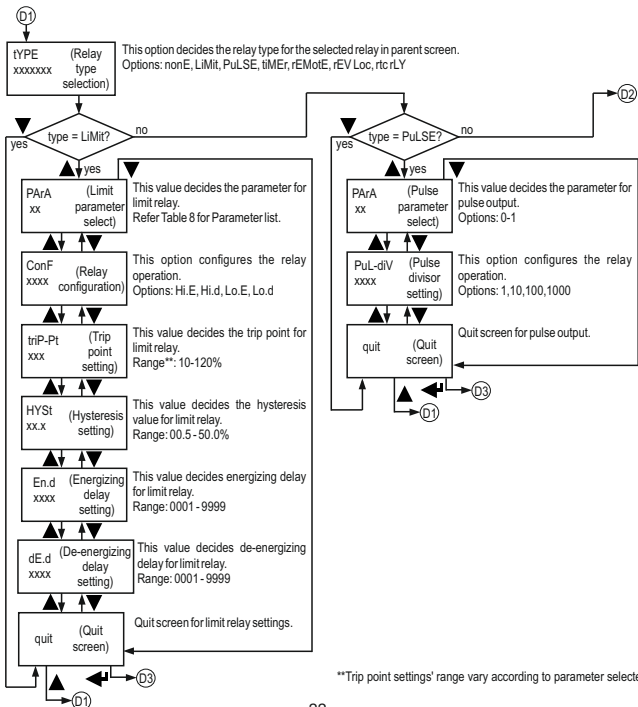

**Trip point settings' range vary according to parameter selected.

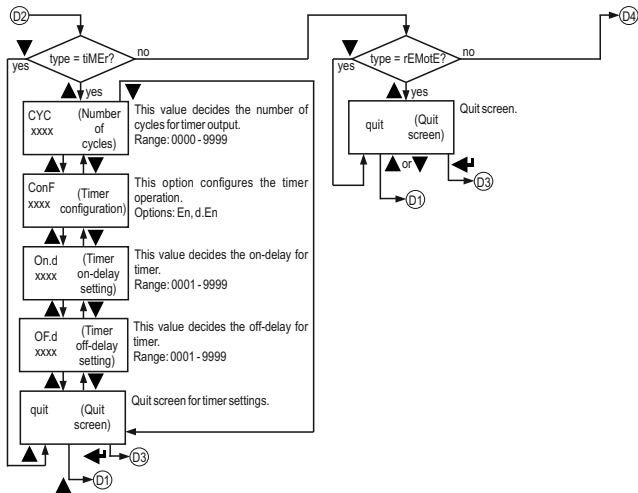

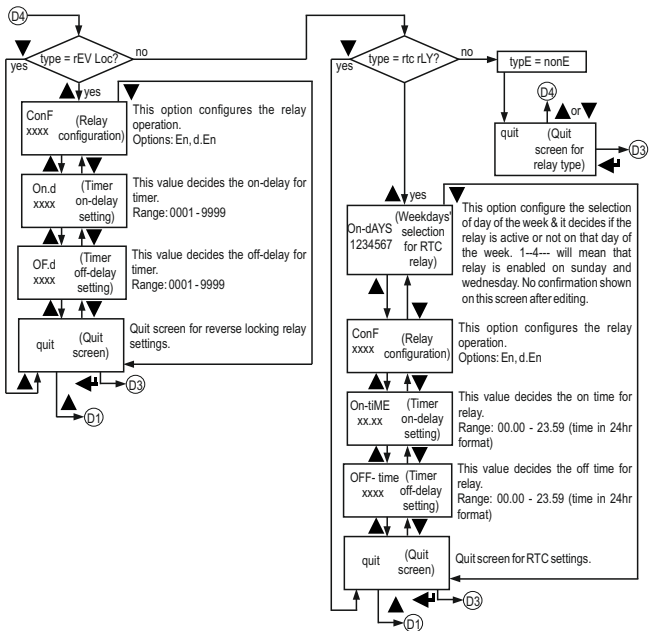

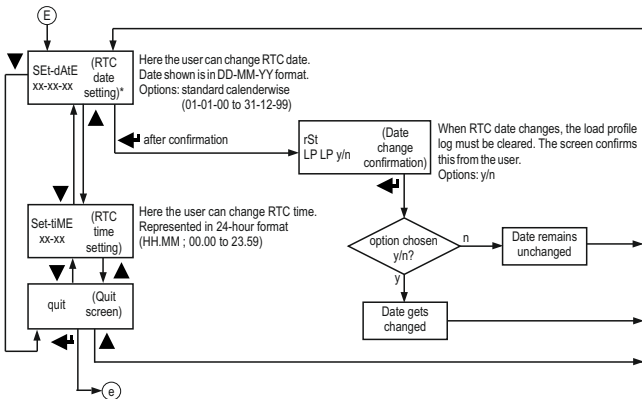

* When changing RTC date, the load profile log also gets cleared. There is a confirmation screen for load profile log reset before date change confirmation.

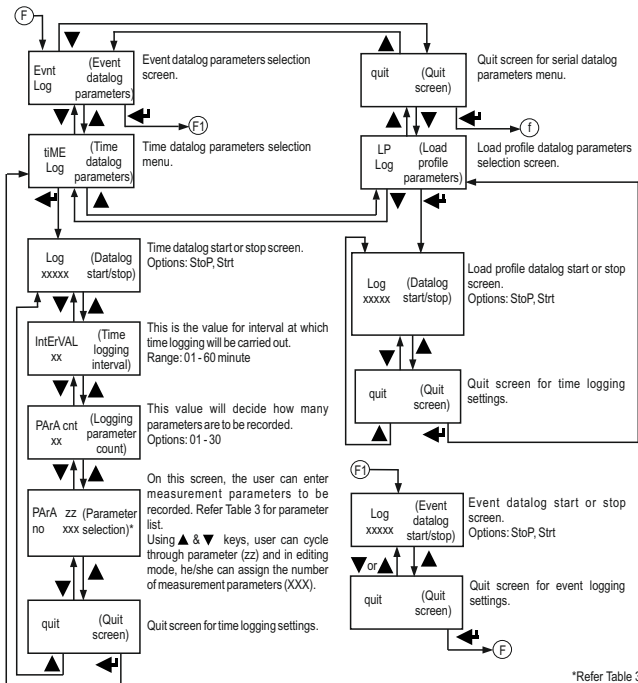

*Refer Table 3

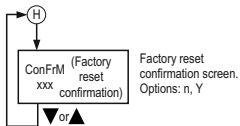
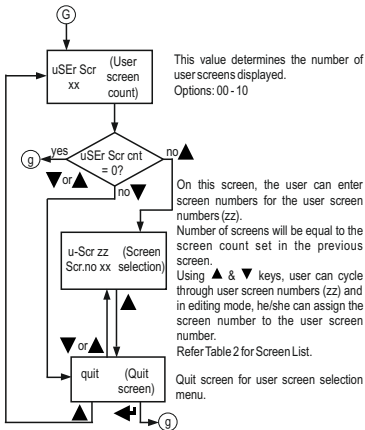

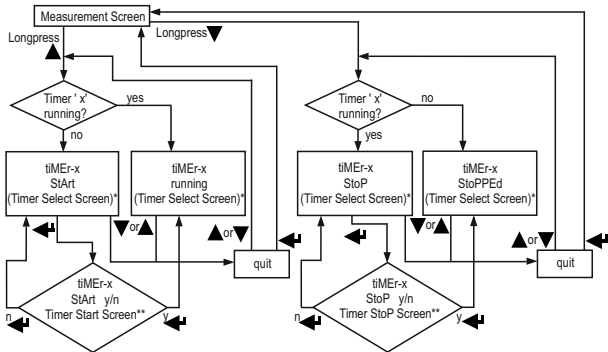

* Value of 'x' can be changed from 1-2 depending on the timers selected in output configuration settings using ▲ and ▼ keys .

** Use ▲ and ▼ keys to select y(yes) or n(no).

7. Programming

The following sections comprise step by step procedures for configuring the DC energy meter according to user requirements. To access the set-up screens press and hold  key for 2 second. This will take the user into the password input screen (Section 7.1).

7.1. Password Protection



Password protection can be enabled to prevent unauthorised access to setup screens.

By default password protection is disabled.

To enable password protection the user need to set a password other than 0000.



Enter Password, prompt for first digit. The symbol * at the first digit denotes that the decimal Point will be flashing. In special case where the Password is "0000" pressing the key when prompted for the first digit will advance to "Password confirmed" screen.

Use  &  keys to increase or decrease the value of the digit. The value can go from 0 to 9 and will wrap around. After reaching the desired digit on display, press  key to confirm and go to the next digit. The decimal point next to the 2nd digit will start flashing.

Following the same steps as above enter all four digits. Pressing enter key after the last digit will take the user to password confirmation screen.



Note: The flashing decimal point indicates the cursor position, a steady decimal point will be present to identify the scaling of the number until the cursor position coincides with steady decimal point position. At this stage the decimal point will flash.



Now when the user presses  key, there are two possibilities for the next screen.

1) If the entered password is correct the display will show the password.

Now pressing  key will let the user enter the setup menu.

And pressing  or  key will allow him/her edit the password again.

2) If the entered password does not match with the current password, the display will show wrong password screen. As shown in below.



Without a valid password user can not enter into the setup menu.

7.2 System Parameter Selection Screen

The first menu in the setup menu is the system parameters menu. In this menu, the user can configure the parameters related to the system within which the instrument will be used and different measurement parameter configurations.

The display text on this screen is shown.



Pressing ▲ or ▼ keys on this screen will navigate through different menu screens as shown in flowchart.

7.2.1 Auto Voltage Detection

This screen can be used to enable (y) or disable (n) auto voltage detection according to the input voltage.



Table-4

Nominal Voltage	Input Voltage
10 - 60V Meter	
12	< 18V
24	>= 18 & <36
48	>= 36 & < 56
60	> 56
61 - 200V Meter	
72	< 90
110	>= 90 & < 135
160	>= 135 & < 180
200	> 180
201 - 1000V Meter	
220	< 235
380	>= 235 & < 450
500	>= 450 & < 600
750	>= 600 & < 800
1000	> 800

Choosing "yes" in the options will set the nominal voltage value. Table-4 shows different nominal voltage values set for different input voltage values.

7.2.2 Nominal Voltage

On this screen the user can set the value of the nominal voltage (voltage full scale V-FS) value for the meter. Range for this value can be any of the three.

- 1) 10 - 60 V
- 2) 61 - 200 V
- 3) 201 - 1000 V

Each parameter screen toggles between its parameter name and its parameter value every 3 seconds.



Parameter Name

Toggles every 3 Sec

Parameter Value



Note: Changing this value will perform a "reset" operation. i.e. all stored parameter values will be erased.

7.2.3 Current Full Scale Value

The nominal full scale current that will be displayed as the currents. This screen enables the user to display the currents without any shunt ratings, the values displayed here represents the currents in ampere. The range for these values is 1-20000 A. The following two screens toggles between its parameter name (A-FS) and its parameter value for 3 sec.





Note: Changing this value will perform a "reset" operation. i.e. all stored parameter values will be erased.

7.2.4 Current Shunt Value

This value is the voltage drop created by the shunt. This value can be set in range of 50 - 150 mV. Each parameter screen toggles between its parameter name and its parameter value every 3 seconds.



Note: Changing this value will perform a "reset" operation. i.e. all stored parameter values will be erased.

7.2.5 Demand Integration Time

This value is the period in minutes over which the current and the power readings are to be integrated. The range for this value is 1 - 30 minutes.

For eg. Screen shows the demand integration time of 1 minutes. That means after 1 minute current and power readings are integrated.



7.2.6 Energy Rate

This value denotes the energy update rate in minutes and can range from 1 - 60 minutes. The energy will be updated on modbus location from 30047 to 30053 and 44143 to 44149 after the time set on this screen. Following screen shows that energy will be updated after every 34 minutes.



7.2.7 Reverse Locking

This screen shows the parameter for reverse locking. Reverse locking is when the current or power is in the opposite direction of the desired direction, the energy and ampere-hour accumulation is stopped. The parameter options are shown below. The energy locking will depend on power direction and the ampere-hour locking will depend on current direction.



Table-5

Code	Value
0	Rev Lock Off
1	Positive / Import
2	Negative / Export

7.2.8 Auto Scrolling

This screen allows user to enable or disable automatic screen scrolling. This feature is disabled by default. The options for this parameter are "yes" or "no".



7.2.9 Noise Current

This screen allows user to set low noise current cutoff. The range for this value is 0 - 30 % of nominal value.

By default it is set to 0%.



7.2.10 Energy Output

This value lets the user decide the energy measurement unit according to the individual requirements. The user can set the unit to Wh, kWh or Mwh. The same is applicable to all types of energy. The options for this setting are 1, 2 or 3 which denote the unit as shown in the table-6.

Table - 6

Code	Unit
1	Wh
2	kWh
3	Mwh



Note: Energy measurement in "Wh" unit is disabled when the nominal power is > 60 kW. Meter will automatically switch to "kWh" if this condition is true.

7.2.11 Energy Digit Reset Count

This screen enables user to set maximum energy count after which energy will roll over to zero. The options for this setting can be 6, 7 or 8 digits.



7.3 Communication Parameter Selection Screen

This menu contains different communication parameters like device address, baud rate, etc. All these parameters are toggle between its parameter name & its parameter value every 3 sec. These settings are applicable only for modbus. For USB, the fixed settings are baud rate - 57600. Parity - no parity, 2 stop bits, Address - 1.



7.3.1 Address Setting

This value decides the device address for modbus communication. This value can range from 001 - 247.



7.3.2 Baud Rate

This value decides the RS485 baud rate. The options for this setting are 4800, 9600, 19200, 38400 and 57600. Default value is set as 9600.



7.3.3 Parity

This value decides the parity bit and the number of stop bits for RS485 communication. The options for this value are as following.

no 1: no parity, 1 stop bit. **no 2:** no parity, 2 stop bits
even: even parity, 1 stop bit. **odd:** odd parity, 1 stop bit

By default, the value for this parameter is set as "no 1".



7.4 Reset Parameter Selection

This screen allows user to reset various stored parameters. When reset is performed, current register values are moved to corresponding "old" registers. The different reset parameters are listed below. The below screens shows the actual reset parameter screen & the parameter that is to be selected for reset operation. i.e. hr - Run and On Hour.



Para Code	Parameter
nonE	None
ALL	All
hr	Run Hour and On Hour
intr	Number of Interrupts
hi	High Voltage & Current
Lo	Low Voltage & Current
En	Energy
dmd	Demand
Ah	Ampere Hour
t.Log	Time Based Log
LoAd	Load Profile Log

7.5 Output Parameter Selection

In this menu the user can configure different output available from the meter. The display text on this screen is shown below.



7.5.1 Select Relay Output

On this screen the user can select relay as the output option and can decide which of the available relay to be used for his/her application. Number of available relays depend on the order code (see datasheet for more information).

On selecting a relay,(As shown in screen 1) the user will be taken to the type selection screen,(As shown in screen 2) which prompts him to select a relay function out of seven available. The options are as following.

- 1) None
- 2) Limit
- 3) Pulse
- 4) Timer
- 5) Remote
- 6) Reverse Lock
- 7) RTC relay



The option "none" implies that the relay is disabled.

7.5.1.1 Limit Relay Configuration

These parameters will decide the operation of limit relay.

7.5.1.1.1 Limit Parameter

This screen enables user to assign any one out of available options for limit relay. The explanation of these options is given in Table-8.



7.5.1.1.2 Limit Configuration

This screen allows the user to select relay configuration out of 4 available options.

- 1) Hi-E
- 2) Hi-d
- 3) Lo-E
- 4) Lo-d



7.5.1.1.3 Trip Point

This is the value for selected parameter limit which is used as a reference for relay tripping. It is represented as percentage value.

Percentage value is calculated on nominal value.

Different ranges for different parameters are shown in table - 8.

Pressing ▲ key increments digit value & pressing ▼ key decrements digit value. Press Enter key to confirm newly changed trip point. The above screens shows the toggle between its parameter name and its value for 3 sec.



7.5.1.1.4 Hysteresis

Hysteresis is the value below high alarm trip point or above low alarm trip point, which when crossed by the measured parameter, resets the relay to its position before tripping. The value of hysteresis can range from 0.5 to 50% and it gets calculated on trip point value.

e.g. The above screen shows the hysteresis value of 50%



7.5.1.1.5 Energizing Delay

Energizing delay is the time in seconds taken by the relay before tripping after an alarm condition has occurred.

The value for this parameter can range from 0001 to 9999.



7.5.1.1.6 De-energizing Delay

De-energizing delay is the time in seconds taken by the relay before coming out of the trip state, after a normal condition has observed. The value for this parameter can range from 0001 to 9999.



7.5.1.2 Pulse Relay Configuration

Pulse relay can be used with a mechanical counter to measure energy. It is a potential free, very fast acting relay contact.

7.5.1.2.1 Pulse Parameter Selection

This parameter decides on which measurement parameter, the pulses will be occurring. The options for this setting are 0 & 1 as explained in Table-7.



Table-7

Code	Configuration
0	Import Energy
1	Export Energy

7.5.1.2.2 Pulse Divisor

This parameter decides after how many units of energy a pulse should appear at output. Refer Table-9 for Pulse Divisor options. Below screens shows the toggle between its parameter name and its value for every 3 sec.



7.5.1.2.3 Pulse Duration

This parameter decides the width of the output pulse. The options for this parameter are 60, 100 and 200 ms as shown below. Below screens shows the toggle between its parameter name and its value for every 3 sec.



7.5.1.3 Timer

This menu contains the parameters for timer output configuration.

7.5.1.3.1 Number of Cycles

This value decides how many times the timer will repeat the switching after once started. If this value is set as 0, timer will keep repeating the cycles until stopped.



7.5.1.3.2 Timer Configuration

Timer configuration decides the relay configuration for timer output. There are two options for this parameter.

- 1) Energize on start
- 2) De-energize on start



7.5.1.3.3 On Delay

On delay is the time in seconds taken by the relay in timer configuration before tripping after it is started. The value for this parameter can range from 0001 to 9999.



7.5.1.3.4 Off Delay

Off delay is the time in seconds taken by the relay in timer configuration before coming out of the trip state, after it has tripped. The value for this parameter can range from 0001 to 9999.



7.5.1.4 Remote Operation

In this mode the meter configures the relay to be controlled via Rs485 modbus communication.

7.5.1.5 Reverse Locking Relay

This relay can be used to control some instrument when reverse polarity of current or powers is observed.

7.5.1.5.1 Relay Configuration

This parameter decides the relay configuration for relay in reverse locking mode. There are two options for this parameter.

- 1) Energize
- 2) De-energize



7.5.1.5.2 On Delay

On delay is the time in seconds taken by the relay in reverse locking configuration before tripping, after a reverse locking is observed. The value for this parameter can range from 0001 to 9999.



7.5.1.5.3 Off Delay

Off delay is the time in seconds taken by the relay in reverse locking configuration, after a normal condition has observed. The value for this parameter can range from 0001 to 9999.



7.5.1.6 RTC Relay

RTC relay can be used to control some instrument automatically over the period of a week repetitively.

7.5.1.6.1 Weekdays selection

On this screen, the user can select on which days the relay should work and on what days it should not work. The numbers on the display denotes days of the week starting from Sunday; i.e. 2 is Monday, 3 is Tuesday and so on (As shown by screen 2). The numbers on the first screen (i.e. 5) denotes if the relay should work on that day corresponding to the number above that digit or not. 1 means the relay works on that day and 0 means it does not work. Below screens shows the toggle between its parameter name and its value for every 3 sec.



7.5.1.6.2 Relay Configuration

This parameter decides the relay configuration for relay in RTC relay mode. There are two options for this parameter.

- 1) Energize
- 2) De-energize



7.5.1.6.3 On Time

On time is the time on which the relay becomes active. This time is represented in 24 hour format HH:MM. The range for this parameter's value is 00:00 to 23:59.



7.5.1.6.4 Off Time

Off time is the time on which the relay deactivates. This time is represented in 24 hour format HH:MM. The range for this parameter's value is 00:00 to 23:59.



7.6 RTC Parameters Setup

This menu allows user to change RTC date and time



7.6.1 Date Setup

User can change the system date from this screen. The date is displayed in DD-MM-YY format and range is 01-01-00 to 31-12-99.



After editing the date user will be prompted that this change will cause a load profile reset. If user confirms this then only the new date will be updated in RTC. (As shown in screen 2)

7.6.2 Time Setup

On this screen the user can change RTC time. Time is displayed in HH:MM format. value ranges from 00.00 to 23.59 as shown in the below screens.



7.7 Datalog Setup Screens

In this menu, the user can set various parameters related to datalogging.



7.7.1 Event Datalog Setup

In this menu, the user can configure settings related to event datalogging.



7.7.1.1 Event Datalog Start/Stop

In this menu, the user can start or stop event datalogging.



7.7.2 Time Datalog Setup

In this menu, the user can set parameters related to time datalogging.



7.7.2.1 Time Datalog Start/Stop

In this menu, the user can start or stop time datalogging.



Note: When this option is set to start, the user will not be allowed to edit other parameters related to time datalog.

7.7.2.2 Interval Selection

This value decides the time interval between two successive time datalog entries. Range for this value is 01-60 minute.



7.7.2.3 Parameter Count

This value decides how many parameters will be logged in time logging.

The value range is 01-30



7.7.2.4 Parameter Selection

On this screen the user can select the measurement parameters to be recorded. Parameter will scroll through parameter count set in previous screen.



In editing mode, the user can see/change the measurement parameter no. The range for this is 00 - 44. Refer Table-3 for Parameter list. The above screens shows the toggle between its parameter name and its value for every 3 sec.

7.7.3 Load Profile Setup

In this menu, the user can edit the parameters related to load profile logging.



7.7.3.1 Load Profile Datalog Start/Stop

In this menu, the user can start or stop load profile datalogging.



7.8 User Assignable Screen Setup

In this menu, the user can configure the user screens.



7.8.1 Number of User Screens

On this screen, the user can set the number of user screens to be displayed. Options for this parameter are 00 - 10. The value 00 will denote that the user screens are disabled and the user screen selection screen will not show up.



7.8.1.1 User Screen no. Selection

This screen shows two parameters.

- 1) Screen
- 2) Screen Count

As shown below -



The screen will scroll through the number of screen selected in previous screen and the user can see/change the screen number in editing mode. The range for this value is 01 - 56. Refer Table-2 for Screens list. The above screen is toggle for every 3 sec.

7.9 Factory Reset

In this menu, the user can factory reset the meter. This will erase all data from the meter and set all setup parameters to their default values.



7.9.1 Factory Reset Confirmation

This screen has the options, no/yes. Selecting 'yes' will start the factory reset process and selecting 'no' will do nothing as shown by the below screen.



Table-8

Para No.	Parameter	Range
0	None	-----
1	Voltage	$\pm 10 - \pm 120\%$
2	Current	$\pm 10 - \pm 120\%$
3	Power	$\pm 10 - \pm 120\%$
4	Import Power Demand	10 - 120%
5	Export Power Demand	10 - 120%
6	Import Current Demand	10 - 120%
7	Export Current Demand	10 - 120%
8	Max Import Power Demand	10 - 120%
9	Max Export Power Demand	10 - 120%
10	Max Import Current Demand	10 - 120%
11	Max Export Current Demand	10 - 120%
12	Import Ampere Hour	10 - 9999999
13	Export Ampere Hour	10 - 9999999
14	Import Energy	10 - 9999999
15	Export Energy	10 - 9999999

Note : - 1. Nominal power = Nom V x Nom I
2. Range in % of nominal value

8. Relay Output

8.1 Limit Relay

Limit relay can be used to monitor the measured parameter in comparison to a set limit.

Relay Configurations

A relay can be configured in one of the four modes given below.

- 1) Hi-E High alarm, energized relay
- 2) Hi-d High alarm, de-energized relay
- 3) Lo-E Low alarm, energized relay
- 4) Lo-d Low alarm, de-energized relay

High alarm relay means that it will go to alarm condition when the measured parameter is greater than the set limit and low alarm relay means it will go to alarm mode when measure parameter is less than the set limit.

Energized relay means that the relay switch will be closed in alarm condition and de-energized relay means that the switch will be open in alarm condition.

Trip Point

This parameter decides the limit for a particular measurement parameter, crossing which the relay goes into alarm mode. These values are defined in percentage of nominal value(except for energy and ampere hour parameters).

For high alarm configuration, the ranges are 10-120%.

For low alarm, configuration, the ranges are 10-100%.

For energy and ampere hour parameters the ranges are 10-9999999.

Example: If nominal voltage value is 48V and trip point is 60%, the absolute value of trip point will be 28.8V(60% of 48).

Hysteresis

Hysteresis is the offset value below high alarm trip point or above low alarm trip point, which when crossed by the measured parameter, resets the relay to its position before tripping i.e. normal condition.

The value of hysteresis can range from 0.5 to 50% and it gets calculated on trip point value.

Example: If trip point is 60% and hysteresis is 25%, then hysteresis value will be equal to 15%(25% of 60).

To get absolute value of hysteresis subtract this much part of nominal value from the trip point in case of high alarm or add this to the trip point value in case of low alarm.

Example:

Nominal value = 48 V,

Trip point (%) = 60%,

Hysteresis (%) = 25 %

Trip value = 60% of 48V = 28.8V

High alarm Hysteresis value = 25 % of 28.8 V = 7.2 V

So, relay will trip above 28.8 V & it will reset below 21.6 V (28.8 V - 7.2 V)

For negative values of trip point, calculations will be the same as positive trip point. Only a negative sign is applied to calculated hysteresis value.

Examples for Different Configurations

a) Trip point = 50%

Hysteresis = 50%

Absolute hysteresis value = 50% - (50% of 50)
= 25%

b) Trip point = -50%

Hysteresis = 50%

Absolute hysteresis value = - [50% - (50% of 50)]
= -25%

Energizing delay = 2s De-energizing delay = 3s

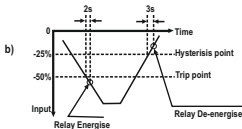
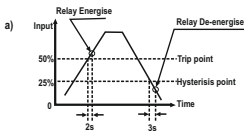
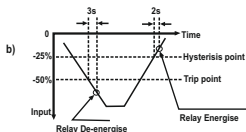
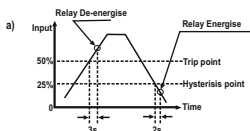
1) High alarm & Energised relay**2) High alarm & De-energised relay**

3) Low alarm & Energised relay

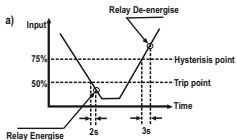

4) Low alarm & De-energised relay

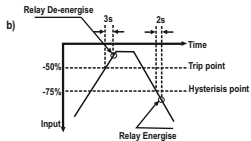
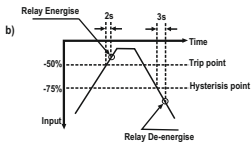
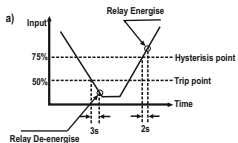

8.2 Pulse Output

Pulse Output is the potential free, very fast acting relay contact which can be used to drive an external mechanical counter for energy measurement. The Pulse Output can be configured to any of the parameter shown in table-7 through setup parameter screen.

TABLE : 9

For energy output in Wh

Pulse Rate		
Divisor	Pulse	Channel Power
1	1per Whr	Up to 3600W
	1per kWhr	Up to 60kW
10	1per 10Whr	Up to 3600W
	1per 10kWhr	Up to 60kW
100	1per 100Whr	Up to 3600W
	1per 100kWhr	Up to 60kW
1000	1per 1000Whr	Up to 3600W
	1per 1000kWhr	Up to 60kW

Note : Energy Output changes from Wh to kWh if system power > 60kW

For energy output in kWh

Pulse Rate		
Divisor	Pulse	Channel Power
1	1per kWhr	Up to 3600kW
	1per MWhr	above 3600kW*

*Applicable to 61...200V and 201...1000V model

For energy output in MWh

Pulse Rate	
Divisor	Pulse
1	1per MWhr

8.3 Timer Output

Timer output can be used to operate the Relay in a cyclic manner.

The user can define the ON period and OFF period and also the number of times this cycle is to be repeated.

The number of Cycles (N) can be indefinite or 1 to 9999. The counting is shown on a measurement screen as explained before.

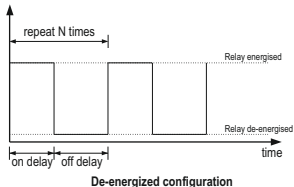
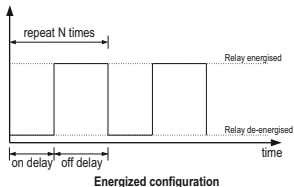

9. Specification :

Inputs Voltage :-

Nominal Input Voltage Range	1. 10-60 VDC 2. 61-200 VDC 3. 201-1000 VDC
Max continuous input voltage	125% of Nominal Value

Input Current :-

No. of Channels	1
Current Sensor	External Shunt
Shunt Setting Range	50mV to 150mV
Full scale Setting Range	1 to 20kA.
Max continuous input current	125% of Nominal value

Operating Measuring Ranges :-

Voltage	$\pm 2\%$ to $\pm 125\%$ of Nominal value
Current	$\pm 0.2\%$ to $\pm 125\%$ of Nominal value
Auxiliary Supply Higher Aux	60V to 300V AC/DC, 45 to 65 Hz
Lower Aux	20V to 60V AC/DC
Nominal Value	230V AC/DC 50/60 Hz for Higher Aux 24V DC for Lower Aux
Overload Indication	"-OL-" >126% of Nominal value (for voltage and current)

VA Burden:-

Nominal input Voltage burden	< 0.4 W approx.
Nominal input Current burden	< 0.1 W approx.
Auxiliary Supply burden	< 6 VA approx.

Accuracy :-

Reference condition	23°C + 2°C
Voltage	$\pm 0.5\%$ of Nominal Value (± 20 to $\pm 120\%$)
Current	$\pm 0.5\%$ of Nominal Value (± 5 to $\pm 120\%$)
Power	$\pm 0.5\%$ of Nominal Value (± 5 to $\pm 120\%$)
Energy	Class 0.5
Temperature drift	$\pm 0.05\%/^{\circ}\text{C}$

Note: Variation due to influence quantity is 100% of class index

Controls :-

User interface	3 push buttons
----------------	----------------

Display :-

Type	1 line 8-digit LED Display
Display Height	9 mm
Overload Indication	-oL- (Above 126% of nominal value)
Update rate	Approx. 1 sec

Display Range :-

Voltage	0 to ± 9999
Current	0 to ± 9999
Power	0 to ± 9999
Energy (Import & Export)	0 to 99999999

Interfaces :-

Impulse LED Relay Output (Optional)	For Energy Testing 250 VAC / 30 VDC, 5 A
Modbus (Optional)	RS485, max. 1200 m Baud rate: 4800, 9600, 19200, 38400, 57600 bps
USB (Optional)	Baud rate: 57600 bps

Overload withstand :-

Voltage input	2 x Rated Value (1s application repeated 10 times at 10s intervals)
Current input	20x Rated value for 1s Repeated 5 times at 5 min intervals

Applicable Standards :-

EMC Immunity	IEC 61326-2012 IEC 61000-4-3. 10V/m min – Level 3 industrial Low level
Safety	IEC 61010-1-2010 , Permanently connected use
IP for water & dust	IEC 60529 (IP 54)
Pollution degree	2
Installation category	1000V CATII, 600V CATIII (Measuring Inputs) 300V CATIII (Power Supply)
Protective Class	2
High Voltage Test (DC, 1 minute)	6.22 kV DC, Enclosure versus all electrical circuits 5.23 kV DC, Auxiliary Supply versus all other electrical circuits 6.22 kV DC, Measuring Terminals versus all other electrical circuit 3.11 kV DC, Relay versus Relay 5.23 kV DC, USB & RS485 versus all other electrical circuits

Environmental conditions :-

Operating temperature	-10 to +55 °C
Storage temperature	-20 to +70 °C
Relative humidity	0 .. 90 % (Non condensing)
Warm up time	3 minute (minimum)
Shock	15g in 3 planes
Vibration	10..55..10 Hz, 0.15 mm amplitude
Number of Sweep Cycles	10 per axis
Enclosure	IP54 (Front Side) and IP20 (Terminal Side)

Dimensions & Weights :-

Bezel Size	96 mm x 96 mm DIN 43 718
Panel Cut-out	92 + 0.8 mm x 92 + 0.8 mm
Overall Depth	75 mm, with addon card 57 mm, without addon card
Weight	320 gm approx.

ModBus (RS 485) Option :-

Protocol	ModBus (RS 485)
Baud Rate	57600, 38400, 19200, 9600 or 4800 (Programmable)
Parity	Odd or Even, with 1 stop bit, Or None with 1 or 2 stop bits

NOTE

The Information contained in these installation instructions is for use only by installers trained to make electrical power installations and is intended to describe the correct method of installation for this product. However, 'manufacturer' has no control over the field conditions which influence product installation.

It is the user's responsibility to determine the suitability of the installation method in the user's field conditions. 'manufacturer' only obligations are responsibility to determine the suitability of the installation method in the user's field conditions. 'manufacturer' only obligations are those in 'manufacturer' standard Conditions of Sale for this product and in no case will 'manufacturer' be liable for any other incidental, indirect or consequential damages arising from the use or misuse of the products.