

Operating Manual

RISH ML14XX Multiload Monitor



DIGITAL MULTIFUNCTION INSTRUMENT

Installation & Operating Instructions

Section	Contents
1.	Introduction
2.	Measurement and Energy / Counter Screens
	2.1 Main Menu Parameter Screens
	2.2 Current Reversal Screen
	2.3 Phase Rotation Error Screen
	2.4 Phase Absent Screen
	2.5 Real Time Clock
	2.6 Individual Harmonics
	2.7 Run Hour
	2.8 On Hour
	2.9 Number of Interruption
3.	Programming
	3.1 Password Protection
	3.2 Menu Selection
	3.2.1 Channel Parameter Selection
	3.2.1.1 Channel mode
	3.2.1.2 Channel Related Voltage
	3.2.1.3 Current Transformer Primary Value
	3.2.1.4 Quit Channel Parameters
	3.2.2 System Parameter
	3.2.2.1 Potential Transformer Primary Value
	3.2.2.2 Potential Transformer Secondary Value
	3.2.2.3 System Frequency
	3.2.2.4 Demand Integration Time
	3.2.2.5 Auto Scrolling
	3.2.2.6 Noise Current Cutoff
	3.2.2.7 No. of Poles
	3.2.2.8 Energy Output
	3.2.2.9 Energy Digit Reset Count
	3.2.2.10 Energy Rate

- 3.2.2.11 Impulse Rate
- 3.2.2.12 Quit System Parameters
- 3.2.3 Communication Parameter Selection
 - 3.2.3.1 Address Setting
 - 3.2.3.2 RS 485 Baud Rate
 - 3.2.3.3 RS 485 Parity
 - 3.2.3.4 Quit Communication Parameters
- 3.2.4 IP Parameter Selection
 - 3.2.4.1 IP Address Setting
 - 3.2.4.2 Subnet mask Setting
 - 3.2.4.3 Default gateway Setting
 - 3.2.4.4 Server Port Setting
 - 3.2.4.5 Quit IP Parameters
- 3.2.5 Reset Parameter Selection
 - 3.2.5.1 Resetting Parameter
- 3.2.6 Output Option Selection
 - 3.2.6.1 Relay Selection
 - 3.2.6.1.1 Relay 1 or 2 Output Selection Menu
 - 3.2.6.1.1.1 Pulse Output
 - 3.2.6.1.1.1.1 Parameter Selection
 - 3.2.6.1.1.1.2 Pulse Duration
 - 3.2.6.1.1.1.3 Pulse Rate
 - 3.2.6.1.1.1.4 Quit Pulse Output
 - 3.2.6.1.1.2 Limit Output
 - 3.2.6.1.1.2.1 Limit Output Parameters
 - 3.2.6.1.1.2.2 Energy Count Configuration
 - 3.2.6.1.1.2.3 Energy Trip Point
 - 3.2.6.1.1.2.4 Energy Count ON Delay
 - 3.2.6.1.1.2.5 Parameter Configuration
 - 3.2.6.1.1.2.6 Trip Point
 - 3.2.6.1.1.2.7 Hysteresis
 - 3.2.6.1.1.2.8 Energizing Delay
 - 3.2.6.1.1.2.9 De-energizing Delay
 - 3.2.6.1.1.2.10 Quit Limit Output
 - 3.2.6.1.1.3 Timer
 - 3.2.6.1.1.3.1 Number of Cycles
 - 3.2.6.1.1.3.2 Timer Configuration

- 3.2.6.1.1.3.3 On Delay
- 3.2.6.1.1.3.4 Off Delay
- 3.2.6.1.1.3.5 Quit Timer Output
- 3.2.6.1.1.4 Load Health
 - 3.2.6.1.1.4.1 Load Health Channel Selection
 - 3.2.6.1.1.4.2 Load Health Configuration
 - 3.2.6.1.1.4.3 Quit Load Health Output
- 3.2.6.1.1.5 Tariff
- 3.2.6.1.1.6 RTC Relay
 - 3.2.6.1.1.6.1 Weekdays Selection
 - 3.2.6.1.1.6.2 Relay Configuration
 - 3.2.6.1.1.6.3 ON Time
 - 3.2.6.1.1.6.4 OFF Time
 - 3.2.6.1.1.6.5 Quit RTC Output
- 3.2.7 Load Health Parameter
 - 3.2.7.1 Unbalance Voltage Limit
 - 3.2.7.2 Unbalance Current Limit
 - 3.2.7.3 Under Frequency Limit
 - 3.2.7.4 Under Voltage Limit
 - 3.2.7.5 Over Voltage Limit
 - 3.2.7.6 Over Current Limit
 - 3.2.7.7 Quit Load Health
- 3.2.8 Tariff Parameter Selection
 - 3.2.8.1 Relay Selection
 - 3.2.8.1.1 Relay 1 or 2 Parameters menu
 - 3.2.8.1.1.1 Parameter Selection
 - 3.2.8.1.1.2 Unit Cost
 - 3.2.8.1.1.3 Topup Recharge
 - 3.2.8.1.1.4 New Recharge
 - 3.2.8.1.1.5 Quit Tariff
- 3.2.9 Datalog Option Selection
 - 3.2.9.1 Event Based Datalog Setup
 - 3.2.9.1.1 Event Based Datalog Selection
 - 3.2.9.1.2 Quit Event Datalog
 - 3.2.9.2 Time Based Datalog Setup
 - 3.2.9.2.1 Time Based Datalog Selection
 - 3.2.9.2.2 Time Interval Selection

- 3.2.9.2.3 Parameter Count
 - 3.2.9.2.4 Parameter Selection
 - 3.2.9.2.5 Quit Time Based Datalog
 - 3.2.9.3 Load Profile Datalog Setup
 - 3.2.9.3.1 Load Profile Datalog Selection
 - 3.2.9.4 Quit Datalog Option
 - 3.2.10 Display Parameters
 - 3.2.10.1 Feature Selection Menu
 - 3.2.10.1.1 Backlit
 - 3.2.10.1.2 User Assignable Screens
 - 3.2.10.1.2.1 Screen Number Selection
 - 3.2.10.1.2.2 User Screens Selection
 - 3.2.10.1.2.3 Quit Userscreens
 - 3.2.10.1.3 Contrast
 - 3.2.10.1.4 Quit Display Parameters
 - 3.2.11 RTC Setting Screen
 - 3.2.11.1 Date Settings
 - 3.2.11.2 Time Settings
 - 3.2.11.3 Quit RTC
 - 3.2.12 Display Diagnosis Parameter
 - 3.2.12.1 Firmware Version
 - 3.2.12.2 All Segment Glow
 - 3.2.12.3 Quit Display Diagnosis Parameter
 - 3.2.13 Factory Reset Screen
 - 3.2.14 Quit
- 4. Energy Auto-Ranging On Display
 - 4.1 Calculating Display energy (Auto-ranging)
 - 4.2 Entering Energy start count
- 5. Relay Output
 - 5.1 Pulse Output
 - 5.2 Limit Switch
 - 5.3 Timer Output
 - 5.4 Tariff
 - 5.5 Load Health
- 6. Phasor Diagram
- 7. Installation
 - 7.1 EMC Installation Requirements

- 7.2 Case Dimensions and Panel Cut-out
- 7.3 Wiring
- 7.4 Auxiliary Supply
- 7.5 Fusing
- 7.6 Earth / Ground Connections
- 8. Connection Diagrams
- 9. Optional Pluggable Module
- 10. Specification
- 11. CT Specification
 - 11.1 CBCT for Residual Current Measurement
 - 11.2 3 PH RJ 12 CT Technical Specification
 - 11.3 Nano CT with RJ 12 Specification
- 12. QuickFix Modules
 - 12.1 5A / 1A to 100mA QuickFix Module
 - 12.1.1 Specifications
 - 12.1.2 Connections
 - 12.1.3 Dimensions
 - 12.2 1Phase to 3Phase QuickFix Module
 - 12.2.1 Connections
 - 12.2.2 Dimensions
 - 12.3 CBCT to RJ12 QuickFix Module
 - 12.3.1 Connections
 - 12.3.2 Dimensions
- 13. Meter Connection diagram with CT
- 14. Connection for Optional Pluggable Module

1. INTRODUCTION

The Meter is a panel mounted 96 x 96 DIN Quadratic Digital Panel Meter. It has 12 single phase load or 4 three phase load option. It measures important electrical parameters of multiple loads simultaneously in a single unit, eliminating the need and cost of multiple panel meters. It provides quick, easy and error free current connections with plug and play connectors. It measures real time electrical parameters like Active / Reactive / Apparent energy and power, current, THD, demand, max demand for each load. The instrument has 4 configurable relay outputs, which can be used for Limit / Pulse / Residual Current / 3Phase Load Health Monitoring / Tariff / RTC / Timer tripping or alarms. This instrument communicates with either MODBUS or Ethernet connection.

It can be configured & Programmed at site for the following : PT Primary, PT Secondary, CT Primary, Channel modes as any combination of 3 Phase 3Wire, 3 Phase 4Wire, 1 Phase 2W system, RCM (Residual Current Monitoring) and NC (No load Connected).

The front panel has four push buttons using which the user can scroll through different screens and configure the instrument. The front panel also has impulse red led, flashing at rate proportional to measured energy.

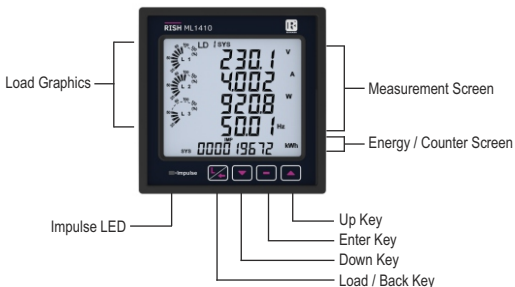

2. MEASUREMENT AND ENERGY/COUNTER SCREENS

The display screen follows a simple menu format. The **Main Menu** (as shown in TABLE 1.2) is the outer-most menu. Refer Section 2.1 "**Main Menu Parameter Screens**" for navigation to the required parameter screen.

Inside the **Load Menu** OR **Total System Menu**, the user is presented with two sub-screens in a single screen as listed below:

1. Sub-screen 1 : One of the **Measurement screens** out of the screens 1 to 45 of TABLE 1.1 OR 1 to 14 of TABLE 1.2. These sub-screens may be scrolled through one at a time in incremental order by pressing the "Up key" and in decremental order by pressing "Down key".
2. Sub-screen 2 : One of the **Energy/Counter screens** out of the screens 46 to 49 of TABLE 1.1 OR 15 to 17 of TABLE 1.2. These sub-screens may be scrolled through one at a time in incremental order only by pressing the "Enter key" to roll over again in the same order.

Load Graphics indicates the input current as the percentage of the CT Primary value. This indication is available for all measurement screens. For example, consider CT Primary to be set at 5A, then the input current of 2.5 A indicates 50% as shown below. **The absence of lines indicating the percentage implies that the input current is less than 20% of the CT Primary value.**

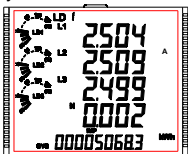

Phase Sequence is also indicated at top left corner of the screen : In case the input is absent or the phase sequence is not L321, the phase sequence indication is not shown.



Counter-Clockwise Sequence, for L321

The Load Menu contains a sub-menu named **Load Channel Information**. This sub-menu lists the Current Channels and the corresponding mode, whether 3P4W Load / 3P3W Load / 1P2W Load / RCM (Residual Current Monitoring) / NC (No Load) that is connected to each of them.

The **RCM, Load Health** and **Tariff** menu provide Residual Current Monitored values, 3 Ph Load Health faults and Cost based Energy Tariff data, respectively.

Similarly, the RTC based Date & Time and parameters of Relay in Timer mode are available in **Miscellaneous Menu**.

TABLE 1.1 : Measurement & Energy/Counter Screens for Load Menu

Screen No.	3P 4W Load	3P 3W Load	1P 2W Load
1	System(V, A, W, HZ)	System(V, A, W, HZ)	Channel(V, A, W, HZ)
2	Phase Volt(L1, L2, L3, AVG)	✘	✘
3	Line to Line Volt(L12, L23, L31)	Line to Line Volt(L12, L23, L31)	✘
4	Phase Current(L1, L2, L3, N)	Phase Current(L1, L2, L3)	✘
5	Phase L1(VA, VAR, W, PF)	✘	✘
6	Phase L2(VA, VAR, W, PF)	✘	✘
7	Phase L3(VA, VAR, W, PF)	✘	✘
8	Phase Angle(L1, L2, L3)	✘	✘
9	System W DMD(Imp,Exp)	System W DMD(Imp, Exp)	Channel W DMD(Imp, Exp)
10	System Var DMD(Cap,Ind)	System Var DMD(Cap, Ind)	Channel Var DMD(Cap, Ind)
11	System DMD(VA, A)	System DMD(VA, A)	Channel DMD(VA, A)
12	W Imp DMD(L1, L2, L3)	✘	✘
13	W Exp DMD(L1, L2, L3)	✘	✘
14	VAR Cap DMD(L1, L2, L3)	✘	✘
15	VAR Ind DMD(L1, L2, L3)	✘	✘
16	VA DMD(L1, L2, L3)	✘	✘
17	Current DMD(L1, L2, L3)	✘	✘
18	Max System W DMD(Imp,Exp)	Max System W DMD(Imp,Exp)	Max Channel W DMD(Imp,Exp)
19	Max System VAR DMD(Cap,Ind)	Max System VAR DMD(Cap,Ind)	Max Channel VAR DMD(Cap,Ind)
20	Max System DMD(VA, A)	Max System DMD(VA, A)	Max Channel DMD(VA, A)
21	Max W Imp DMD(L1, L2, L3)	✘	✘
22	Max W Exp DMD(L1, L2, L3)	✘	✘
23	Max VAR Cap DMD(L1, L2, L3)	✘	✘
24	Max VAR Ind DMD(L1, L2, L3)	✘	✘
25	Max VA DMD(L1, L2, L3)	✘	✘
26	Max Current DMD(L1, L2, L3)	✘	✘
27	RPM, Frequency	RPM, Frequency	RPM, Frequency
28	System(VA, VAR, W)	System(VA, VAR, W)	Channel(VA, VAR, W)
29	System(VA, Var, PA, PF)	System(VA, Var, PA, PF)	Channel(VA, Var, PA, PF)
30	Min system (V, A)	Min system (V, A)	Min Channel (V, A)

TABLE 1.1 : Continue...

Screen No.	3P 4W Load	3P 3W Load	1P 2W Load
31	Max system(V, A)	Max system(V, A)	Max Channel(V, A)
32	Min Volt(L1, L2, L3)	✘	✘
33	Max Volt(L1, L2, L3)	✘	✘
34	Min Volt(L12, L23, L31)	Min Volt(L12, L23, L31)	✘
35	Max Volt(L12, L23, L31)	Max Volt(L12, L23, L31)	✘
36	Min Current(L1, L2, L3)	Min Current(L1, L2, L3)	✘
37	Max Current(L1, L2, L3)	Max Current(L1, L2, L3)	✘
38	%THD Volt(L1, L2, L3)	%THD Volt(L1, L2, L3)	✘
39	%THD Current(L1, L2, L3)	%THD Current(L1, L2, L3)	✘
40	System %THD(V, A)	System %THD(V, A)	Channel %THD(V, A)
41	Current reverse	✘	Current reverse
42	Phase reversal	Phase reversal	✘
43	Phase absent screen	✘	✘
44	Individual harmonic(V%)	Individual harmonic(V%)	Individual harmonic(V%)
45	Individual harmonic(A%)	Individual harmonic(A%)	Individual harmonic(A%)
46	System Wh(Imp, Exp)	System Wh(Imp, Exp)	Channel Wh (Imp, Exp)
47	System VARh(Cap, Ind)	System VARh(Cap, Ind)	Channel VARh(Cap, Ind)
48	System VAh	System VAh	Channel VAh
49	System Run hour	System Run hour	Channel Run hour

Note 1: Screens with screen number 46 to 49 are not available for selectable Userscreens.

Note 2: Energy on display is Auto-Ranging, for details refer the Operating Manual.

TABLE 1.2 : Measurement Screens (Menu-wise)

Screen No.	Total System Menu	Load Channel Info Sub-menu	RCM Menu
1	Total (V, A, W)	Channel 1 Load information	Residual Current
2	Total (VA, VAR, W)	Channel 2 Load information	Min Residual Current
3	Total (Angle)	Channel 3 Load information	Max Residual Current
4	Total (Power factor)	Channel 4 Load information	
5	Total (RPM)	Channel 5 Load information	
6	Total (Frequency)	Channel 6 Load information	
7	Total import W demand	Channel 7 Load information	
8	Total export W demand	Channel 8 Load information	
9	Total VAR demand (ind., cap.)	Channel 9 Load information	
10	Total demand (VA, A)	Channel 10 Load information	
11	Max Total import W demand	Channel 11 Load information	
12	Max Total export W demand	Channel 12 Load information	
13	Max Total VAR demand (ind.,cap.)		
14	Max Total demand (VA, A)		
15	Total Energy(kW,VAR,VA)		
16	Instrument On Hour		
17	Instrument interruptions		

Note : Screens with screen number 15 to 17 are not available for selectable Userscreens.

TABLE 1.2 : Continue...

Screen No.	Tariff Menu	Main Menu*	Miscellaneous Menu
1	Relay 1 Balance Energy	Show Load Data	Date & Time
2	Relay 1 Balance Cost	Show Total Data	Timer 1 cycles/on/off delay
3	Relay 2 Balance Energy	Show RCM Data	Timer 2 cycles/on/off delay
4	Relay 2 Balance Cost	Show LD Health for all 3ph sys	Timer 3 cycles/on/off delay
5	Relay 3 Balance Energy	Show Tariff Data	Timer 4 cycles/on/off delay
6	Relay 3 Balance Cost	Show Miscellaneous Data	
7	Relay 4 Balance Energy		
8	Relay 4 Balance Cost		

***Note : From the Main Menu, only “Show Load Health for all 3ph sys” is available for selectable Userscreen.**

2.1 Main Menu Parameter Screens

L/← : LOAD/BACK KEY
↑ : UP KEY
□ : ENTER KEY
↓ : DOWN KEY

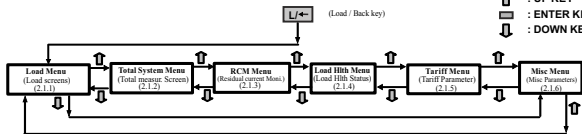

2.1.1 Load Menu Screen



This menu contains the measurement screens of all the loads (See TABLE 1.1) as well as Load Channel Information (See TABLE 1.2)

Pressing "▲" key advances to "Total system menu" (see Section 2.1.2).
Pressing "▼" key advances to "Misc Menu" (see Section 2.1.6).
Pressing "■" key prompts to measurement parameters screens.

Inside the Load Menu, Pressing "L/←" key scrolls through all the load connected to meter as well as load channel info menu (see Section 2.1.1.1).

Note : Number of loads depends on the channel mode setting, e.g.,
1) When all the channel mode are 3 phase then there will be total 4 loads.
2) When all the channel mode are 1 phase then there will be total 12 loads.
3) If mode of channel 1,2,3 is 4 (3P4W) and the rest are single phase, then number of loads = 10.

2.1.1.1 Load Channel info



Pressing "▲" key advances to "quit Load menu" screen (see Section 2.1.1.2). Pressing "▼" key advances to the last "Load measurement screen". Pressing "■" key prompts to "Load channel info" screens (see Section 2.1.1.1.1).

2.1.1.1.1 Load Info Screen



This Screen shows channel mode of the load.
Pressing "▲", "▼" or "L/←" key scrolls through the load info screens.

Pressing " L/← " key for >1sec advances to "Load channel info" screen (see Section 2.1.1.1)

Pressing "▲" key scrolls through all the channels and advances to "quit load menu" (see Section 2.1.1.2).

2.1.1.2 Quit Load Menu



Pressing "▲" key advances to measurement screens.

Pressing "▼" key advances to "Load channel info" screen (see Section 2.1.1.1).

Pressing "←" key prompts to "Load menu" screen (see Section 2.1.1).

2.1.2 Total system menu



This menu provides the Total system parameter measurement screens as shown in TABLE 1.2

Pressing "▲" key advances to "RCM menu" (see Section 2.1.3).

Pressing "▼" key advances to "Load Menu" (see Section 2.1.1).

Pressing "←" key prompts to measurement parameters screens.

After going to measurement screen Pressing "▲" key scrolls through measurement screens and at end "quit total system menu" screen (see Section 2.1.2.1) is shown.

2.1.2.1 Quit Total system Menu



Pressing "▲" or "▼" key advances to measurement screens.
Pressing "■" key prompts to "Total system menu" screens (see Section 2.1.2).

2.1.3 RCM Menu

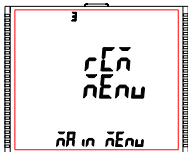

This Screen shows the RCM parameter screens as shown in **TABLE 1.2**
Pressing "▲" key advances to "Load health menu" (see Section 2.1.4).
Pressing "▼" key advances to "Total system Menu" (see Section 2.1.2).
Pressing "■" key prompts to measurement parameters screens.

This menu is used to display channel current, channel min current and channel max current.

Note:

- 1) This menu is applicable only when channel mode (see Section 3.2.1.1) is selected as "rcm".
- 2) If channel mode is not set as "rcm", then this screen will show "rcm not sel".

2.1.3.1 Channel mode not set as "rcm"



This Screen shows the RCM not selected.
Pressing "▲" or "▼" key advances to "quit rcm menu" (see Section 2.1.3.2).

2.1.3.1 Channel mode set as “rcm”

This Screen shows the Residual Current Monitored parameter.
Pressing “▲” or “▼”key advances to channel wise current parameter.

- 1) Channel current
- 2) Channel min current
- 3) Channel max current

Total 12 channel rcm parameter can be display if all the channel mode are set as rcm.
If any one of the channels of Group (1,2,3) / (4,5,6) / (7,8,9) / (10,11,12) is set in RCM mode, then all the channels of the corresponding group would be allocated for RCM measurements.

Note: when the system is set as rcm then CT primary of all the channel of that system is set as 30.

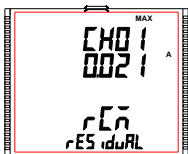
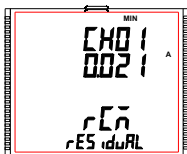
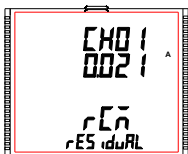

2.1.3.2 Quit RCM Menu



Pressing “▲” or “▼” key advances to “RCM not selected or RCM channel current measurement” screen (see Section 2.1.3.1).
Pressing “—” key prompts to “rcm menu” screens (see Section 2.1.3).

2.1.4 Load health Menu



Pressing "▲" key advances to "triff menu" (see Section 2.1.5).
Pressing "▼" key advances to "rcm menu" (see Section 2.1.3).
Pressing "■" key prompts to "Load health status" screens (see Section 2.1.4.1).

2.1.4.1 Load health status

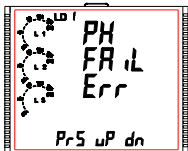

This Screen shows health status of all the 3 phase loads.
Pressing "▲" or "▼" key advances to different errors of the corresponding load.

Types of errors shown:

- | | |
|----------------------|----------------------|
| 1) over current | 2) over voltage |
| 3) under voltage | 4) under frequency |
| 5) Phase fail | 6) Phase reversal |
| 7) unbalance current | 8) unbalance voltage |

Pressing "L/←" key advances to next 3 phase load health status screen. Maximum 4 loads of 3 phase system can be connected to meter. Pressing "L/←" key advances to "quit load health menu" (see Section 2.1.4.2).

2.1.4.2 Quit load health menu



Pressing "▲" key advances to first load health status screen.
Pressing "▼" key advances to last load health status screen.
Pressing "■" key scrolls through the loads.
Pressing "L/←" key for >1sec or pressing "■" key advances to "Load health menu" (see Section 2.1.4)

2.1.5 Tariff Menu

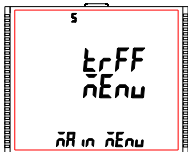

Pressing "▲" key advances to "Misc menu" (see Section 2.1.6).
Pressing "▼" key advances to "Load health menu" (see Section 2.1.4)
Pressing "■" key prompts to "Relay 1 or 2 balance energy" screens (see Section 2.1.5.1).

Note: This menu is applicable only when relay output is set in Tariff mode (see Section 3.2.6.1)

2.1.5.1 Relay 1 or 2 balance energy



This Screen shows Balance energy of the parameter selected in the relay output tariff mode.

Pressing "▲" key advances to "Relay 1 or 2 balance cost" (see Section 2.1.5.2).

Pressing "▼" key advances to "quit trff menu" (see Section 2.1.5.3)

2.1.5.2 Relay 1 or 2 balance cost



This screen shows the balance cost of the parameter selected in the relay output tariff mode.

Pressing "▲" key advances to "quit trff menu" (see Section 2.10.5.3).

Pressing "▼" key advances to "Relay 1 or 2 balance energy" (see Section 2.10.5.1).

2.1.5.3 Quit Tariff Menu



- Pressing "▲" key advances to "Relay 1 or 2 balance energy" (see Section 2.1.5.1).
- Pressing "▼" key advances to "Relay 1 or 2 balance cost" (see Section 2.1.5.2)
- Pressing "←" key prompts to "tariff menu" screens (see Section 2.1.5).

2.1.6 Miscellaneous Menu

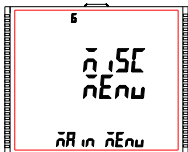

- This Screen shows Timer 1 and Timer 2 parameter.
- Pressing "▲" key advances to "Load menu" (see Section 2.1.1).
- Pressing "▼" key advances to "trff menu" (see Section 2.1.5)
- Pressing "←" key advance to "Timer 1 and Timer 2 screen" (see Section 2.1.6.1)

2.1.6.1 Timer 1 & Timer 2 Screens

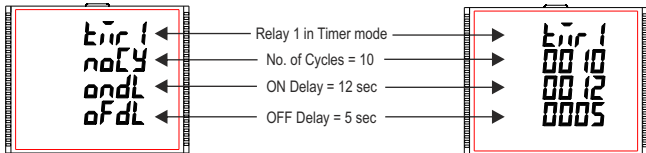

The screen shows the No. of Cycles, on delay, off delay of the corresponding relay in its timer mode. If the relay is configured in timer mode, then the timer can be turned ON by long press (about 3sec) of Up key while present in any of the measurement screens.

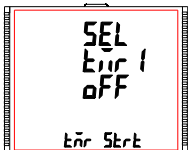

Relay 1 is not selected in Timer Configuration.

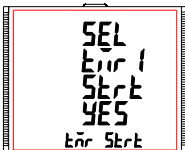

This screen is shown when relay is configured as timer by selecting yes option timer1 can be started.

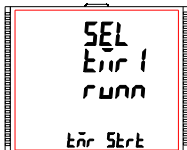

Timer showing Running when it is started.

Similarly, the Relay can be turned OFF by long press (about 3sec) of Down key while present in any of the measurement screens.

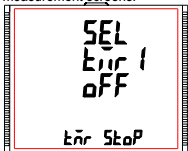

Relay 1 is not selected in Timer Configuration.



This screen is shown when timer is started by selecting yes option timer1 can be stopped.



Timer showing Stopped when not running.

2.1.6.2 Quit Miscellaneous Menu



Pressing "▲" or "▼" key advances to "Timer 1 or Timer 2" screen (see Section 2.1.6.1).

Pressing "■" key prompts to "misc menu" screens (see Section 2.1.6).

2.2 Current Reversal Screen

This screen is useful to indicate if current in any phase is reversed or not. If current in any phase gets reversed, then corresponding phase will be indicated on this screen.

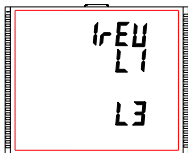

This screen shows that currents in L1 and L3 are reversed.

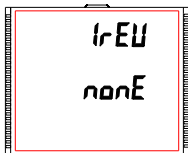

This screen shows that currents in all three phase are correct.

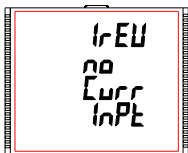

This screen shows that the meter has no current input.

2.3 Phase Rotation Error Screen

Meter shows phase rotation information for the phase sequence R-Y-B (L1-L2-L3).

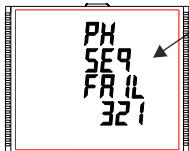

This screen indicates that Phase Sequence is incorrect.

This screen indicates that all three phases (voltages) are absent.

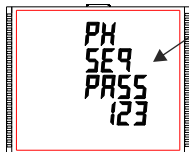
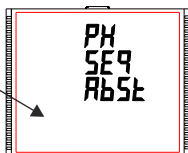

This screen indicates that Phase Sequence is correct.

This screen indicates that either one or two of the three phases (voltages) are absent.

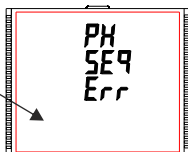

User must check this screen in order to get correct readings when meter is connected.

2.4 Phase Absent Screen

This screen is useful to indicate if voltage or current in any phase is absent. Hence, user will know which voltage or current is missing and take corrective action.

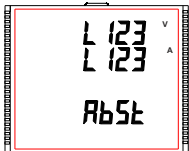

This screen indicates that all three phases (volt. & current) are absent.

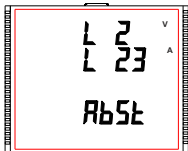

This screen indicates that V2, I2 and I3 are absent.



This screen indicates that all three phases are present i.e. all inputs are present.

2.5 Real Time Clock

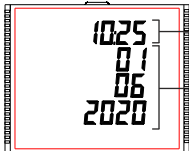

Time of the day (HH:MM in 24 hour format)

Date of the day (DD/MM/YYYY)

2.6 Individual Harmonics



The **Individual Harmonics** can be accessed by pressing the Enter key followed by the Up and Down keys taking through the 31 harmonics.



Similarly, pressing the " = " key at the **quit screen** takes the user out of the Individual Harmonics Screen.

2.7 Run Hour



This Screen shows the total no. of hours the load is connected. Even if the Auxiliary supply is interrupted, count of Run hour will be maintained in internal memory & displayed in the format "hours. min".

For example if Displayed count is 105000 it indicates 105000 hours. After 999999 run hours display will restart from zero. To reset run hour manually see section Resetting Parameter 3.2.5.

2.8 On Hour

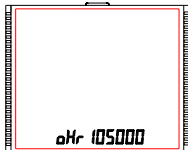

This Screen shows the total no. of hours the Auxiliary Supply is ON. Even if the Auxiliary supply is interrupted count of On hour will be maintained in internal memory & displayed in the format "hours. min".

For example if Displayed count is 105000 it indicates 105000 hours. After 999999.59 On hours display will restart from zero. To reset On hour manually see section Resetting Parameter 3.2.5.

2.9 Number of Interruption

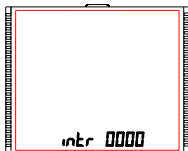

This Screen Displays the total no. of times the Auxiliary Supply was Interrupted. Even if the Auxiliary supply is interrupted count will be maintained in internal memory. To reset No of Interruption manually see section Resetting Parameter 3.2.5

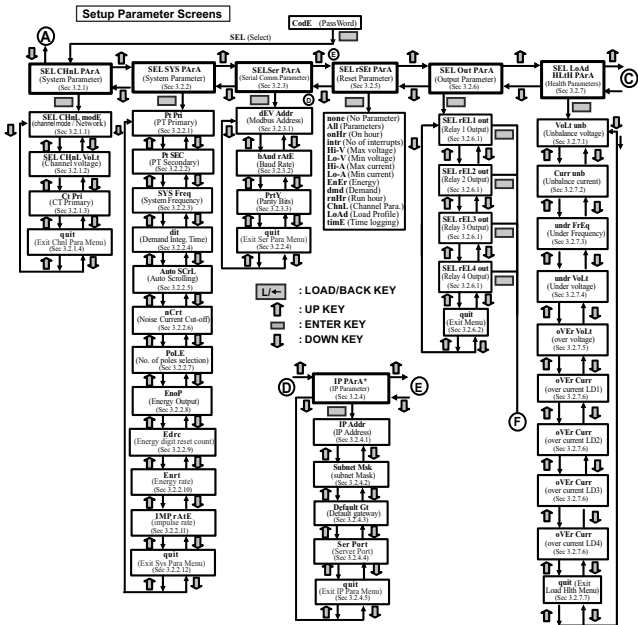

Note*: IP Menu is available only in case of Ethernet option.

Note: Long press (>1sec) of “L/←” key exits the present menu and advances to the outer menu.

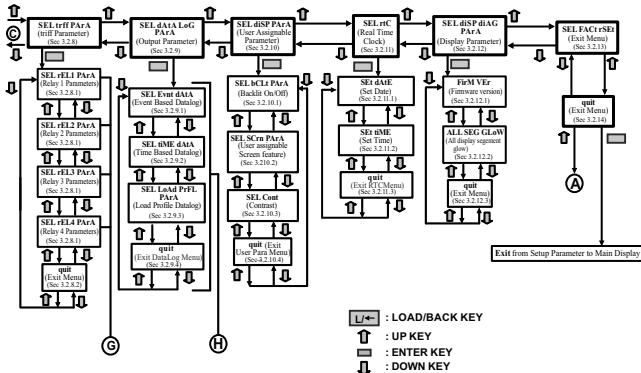

Tariff Parameter Settings

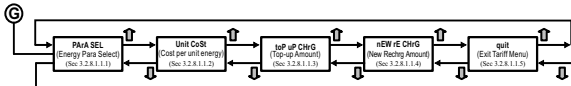

Output Options Parameters

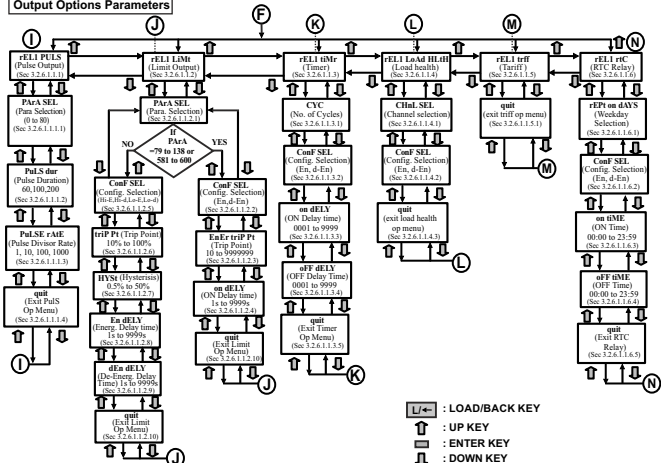

Datalog Options Parameters

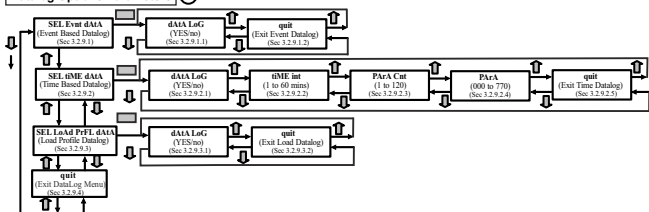

3. PROGRAMMING

The following sections comprise step by step procedures for configuring the Multifunction Meter according to individual user requirements. To access the set-up screens press and hold "▲ UP" and "▼ DOWN" keys simultaneously for 5 seconds. This will take the User into the Password Protection Entry Stage (Section 3.1).

3.1. Password Protection

Password protection can be enabled to prevent unauthorised access to set-up screens, when default password protection is not enabled. Password protection is enabled by selecting a four digit number other than 0000, setting a password of 0000 disables the password protection.

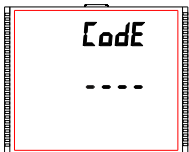

Enter Password, prompt for first digit. Press the "▲" key to scroll the value of first digit from 0 through to 9, the value rolls back from 9 round to 0 and "▼" key to scroll the value of first digit from 9 through to 0, the value rolls back from 0 round to 9.

Press the "■" key to advance to next digit.

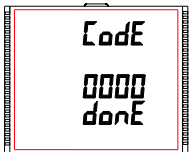

In special case where the Password is "0000" pressing the "■" key when prompted for the first digit advances to the password accepted screen and then pressing the "■" key again makes the set-up screens accessible to the user.

But instead of pressing the "■" key, if "▲" or "▼" key is pressed, the user is taken to the "New/change Password" entry stage.

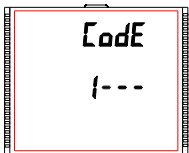

Enter Password, first digit entered, prompt for second digit..

Press the "▲" key to scroll the value of first digit from 0 through to 9, the value rolls back from 9 round to 0 and "▼" key to scroll the value of first digit from 9 through to 0, the value rolls back from 0 round to 9.

Press the "■" key to advance to next digit.

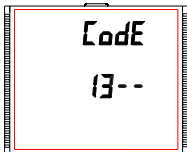

Enter Password, second digit entered, prompt for third digit.

Press the "▲" key to scroll the value of first digit from 0 through to 9, the value rolls back from 9 round to 0 and "▼" key to scroll the value of first digit from 9 through to 0, the value rolls back from 0 round to 9.

Press the "▬" key to advance to next digit.

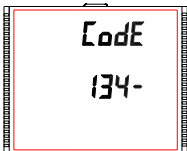

Enter Password, third digit entered, prompt for fourth digit .

Press the "▲" key to scroll the value of first digit from 0 through to 9, the value rolls back from 9 round to 0 and "▼" key to scroll the value of first digit from 9 through to 0, the value rolls back from 0 round to 9.

Press the "▬" key to advance to verification of the password.

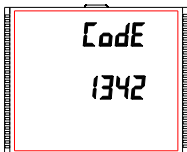

Enter Password, fourth digit entered, awaiting verification of the password.

Password confirmed.

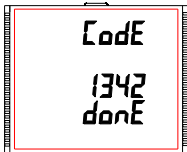

Pressing "▲" or "▼" key advances to the "New / change Password" entry stage.

Pressing the "▬" key advances to the Menu selection (setup menu) screen (see Section 3.2).

Password Incorrect.

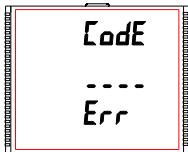

The unit has not accepted the Password entered.

Pressing the "▲" or "▼" key advances to the Enter Password stage.

Pressing the "■" key exits the Password menu & returns operation to the measurement reading mode.

New / Change Password

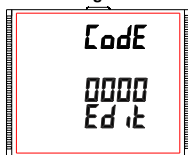

Prompting for first digit.

Press the "▲" and "▼" keys to scroll the value of first digit from 0 through to 9 and from 9 through to 0, respectively with digit roll around feature.

Pressing the "■" key advances the operation to the next digit and sets the first digit, in this case to "2"

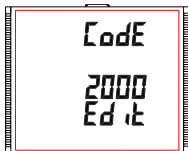

New/ Change Password, first digit entered, prompting for second digit.

Press the "▲" and "▼" keys to scroll the value of second digit from 0 through to 9 and from 9 through to 0, respectively with digit roll around feature.

Pressing the "■" key advances the operation to the next digit and sets the second digit, in this case to "1".

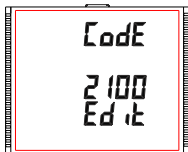

New/ Change Password, second digit entered, prompting for third digit.

Press the "▲" and "▼" keys to scroll the value of second digit from 0 through to 9 and from 9 through to 0, respectively with digit roll around feature.

Pressing the "■" key to advance the operation to the next digit and sets the third digit, in this case to "5".

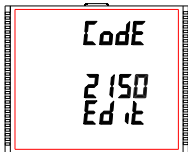

New/ Change Password, third digit entered, prompting for fourth digit. .

Press the "▲" and "▼" keys to scroll the value of second digit from 0 through to 9 and from 9 through to 0, respectively with digit roll around feature.

Pressing the "■" key to advance the "New Password Confirmed" and sets the fourth digit, in this case to "3".

New Password confirmed

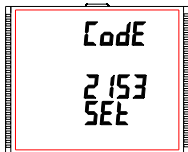

Pressing the "▲" or "▼" key returns to the "New/Change Password" stage.

Pressing the "■" key advances to the Menu selection screen (see Section 3.2).

3.2 Menu selection

3.2.1 Channel Parameter Selection



This screen is used to select different channel Parameters like "channel mode", "Channel voltage type" and "CT Primary". Pressing the "■" key allows the user to set Different channel parameters (see Section 3.2.1.1 to 3.2.1.4).

Pressing the "▲" key advances to the "System Parameter Selection" screen (see section 3.2.2) and pressing "▼" key advances to the "Quit Setup" Screen (see section 3.2.14).

3.2.2 System Parameter Selection



This screen is used to select different system Parameters like "PT Ratio", "System frequency", etc. Pressing the "◀" key allows the user to set Different system parameters (see Section 3.2.2.1 to 3.2.2.11).

Pressing the "▲" key advances to the "Communication Parameter Selection" screen (see section 3.2.3) and pressing "▼" key advances to the "Channel Parameter selection" Screen (see section 3.2.1).

3.2.3 Communication Parameter Selection



This screen is used to select the different communication parameters like "Address selection", "RS485 Parity selection", "RS485 baud rate", etc.

Pressing the "◀" key allows the user to set different Communication parameters (see Section 3.2.3.1 to 3.2.3.3).

Pressing the "▲" key advances to the "Reset Parameter Selection" screen (if ethernet module is present then it will advance to IP parameter selection see section 3.2.4) (see section 3.2.5) and pressing "▼" key advances to the "System Parameter Selection" screen (see Section 3.2.2).

3.2.4 IP Parameter Selection



This screen is used to select the different communication parameters like "IP Address selection", "Subnet mask selection", "default gateway selection", "server port selection" etc.

Pressing the "◀" key allows the user to set different Ethernet parameters (see Section 3.2.4.1 to 3.2.4.5).

Pressing the "▲" key advances to the "Reset Parameter Selection" screen (see section 3.2.5) and pressing "▼" key advances to the "Communication Parameter Selection" screen (see Section 3.2.2).

3.2.5 Reset Parameter Selection



This screen is used to reset different parameters.

Pressing the "←" key allows the user to reset different system parameters (see Section 3.2.5.1).

Pressing the "▲" key advances to the "Output Option Selection" screen (see Section 3.2.6) and pressing "▼" key advances to "Communication Parameter Selection" screen (If ethernet module is present then it advances to IP parameter selection else it goes to serial communication parameter selection (see Section 3.2.3).

3.2.6 Output Option Selection



This screen will allow the user to select Output Options like "Relay Output".

Pressing the "←" key allows the user to select and configure the output options (see Section 3.2.6.1).

Pressing "▲" key advances to the "Load health Parameter Selection" screen (see section 3.2.7) and pressing "▼" key advances to "Reset Parameter Selection" screen (see Section 3.2.5).

3.2.7 Load Health Parameter Selection



This screen will allow the user to select Load health parameters like "Unbalance voltage", "Unbalance current", "Under voltage", etc.

Pressing the "←" key allows the user to select and configure the Load health parameters (see Section 3.2.7.1 to 3.2.7.6).

Pressing "▲" key advances to the "Tariff parameter selection" screen (see section 3.2.8) and pressing "▼" key advances to "output option Selection" screen (see Section 3.2.6).

3.2.8 Tariff Parameter Selection



This screen will allow the user to select Tariff Parameter options like "Relay Parameters".

Pressing the "■" key allows the user to select and configure the Parameter options (see Section 3.2.8.1).

Pressing the "▲" key advances to the "Datalogging" screen (see section 3.2.9) and pressing "▼" key advances to "Load health parameter Selection" screen (see Section 3.2.7).

3.2.9 Datalog Option Selection



This screen will allow the user to select Datalog Options like "Event Based", "Time Based" and "Load Profile".

Pressing the "■" key allows the user to select and configure the datalog options (see section 3.2.9.1).

Pressing the "▲" key advances to "Display Parameters" screen (see section 3.2.10) and pressing "▼" key advances to "Tariff Parameter Selection" screen (see Section 3.2.8).

3.2.10 Display Parameters



This screen will allow the user to access different features like "Backlit", "Screens" and "Contrast".

Pressing the "■" key allows the user to select and configure the features (see Section 3.2.10.1).

Pressing the "▲" key advances to "RTC Setting" screen (see Section 3.2.11) and pressing "▼" key advances to "Datalog Option Selection" screen (see Section 3.2.9).

3.2.11 RTC Setting



This screen will allow the user to access features like "Set Date" and "Set Time".

Pressing the "■" key allows the user to select date and time (see Section 3.2.11.1).

Pressing the "▲" key advances to "Display diagnosis" screen (see Section 3.2.12) and pressing "▼" key advances to "Display Parameters" screen (see Section 3.2.10).

3.2.12 Display diagnosis



This screen will allow the user to watch "Firmware version" and "All display segments".

Pressing the "■" key allows the user to select firmware version and All segment glow screen (see Section 3.2.12.1).

Pressing the "▲" key advances to "Factory reset" screen (see Section 3.2.13) and pressing "▼" key advances to "RTC" screen (see Section 3.2.11).

3.2.13 Factory Reset

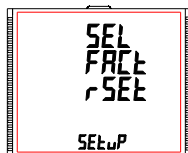

This screen allows the user to set the meter to its Factory Default settings (see Section 3.2.13).

Pressing the "▲" key advances to "Quit Setup" screen (see Section 3.2.14) and pressing "▼" key advances to "Display diagnosis" screen (see Section 3.2.12).

3.2.14 Quit Setup

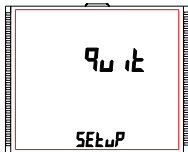

This screen will allow the user to quit the setup menu(see Section 3.2.14.1)

Pressing the "■" key allows the user to Quit from setup menu & return to measurement screen.

Pressing the "▲" key advances to "Channel Parameter Selection" screen (see Section 3.2.1) and pressing "▼" key advances to "Factory Reset" screen (see Section 3.2.13).

3.2.1 Channel Parameter Selection

3.2.1.1 Channel mode



This screen is used to set the channel mode.

Pressing the "←" key advances into the channel mode and pressing the "▲" and "▼" key scrolls through the load screens available:

channel mode "3P3W" for 3 phase 3 wire, "3P4W" for 3 phase 4 wire system, "1P2W" for single phase system, "rCM" for residual current monitoring and "oFF" for no load selected.

Pressing the "←" key advances to channel mode edit mode screen, accepting the present value. Pressing "▲" advances to next load screen for setting the channel mode and pressing "▼" key advances to "quit" screen.

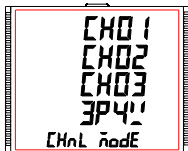

Once the channel mode is set and "Channel mode" menu appears (see Section 3.2.1.1), pressing "▲" key advances to the "Channel voltage type" screen (see Section 3.2.1.2) and pressing the "▼" key advances to "Quit" screen (see Section 3.2.1.5).

Default value is set to '3P4W'.

⚠ Caution: If channel mode is changed channel data gets reset.
1) User screen resets to its default value. (see Section 3.2.10.1.2.1)
2) Impulse energy (resets to none), Relay output mode (3.2.6.1.1), Tariff parameter selection (3.2.8.1.1.1) and time based datalog (3.2.9.2.4) will reset to its default value if the parameter is invalid.

3.2.1.2 Channel Related Voltage



This screen is used to show the channel Related Voltage.

Pressing "←" key advances to screen showing channel voltage, Pressing "▲" advances to "CT Primary" screen and Pressing "▼" key advances to "Channel mode" screen.

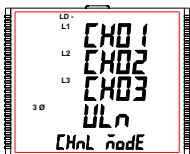

This screen is used to show the channel voltage.

V1Ln, V2Ln & V3Ln : indicate single phase system line to neutral voltages.
 VLn : when the system is 3P4W.
 VLL : when the system is 3P3W.

Note: Changing related voltage will reset all the channel data of the corresponding channel.

3.2.1.3 Current Transformer Primary Value

The nominal Full Scale Current that will be displayed as the Line currents. This screen enables the user to display the Line currents, the values displayed represent the Current in Amps.



Pressing the "▲" key advances to the "quit" screen (see Section 3.2.1.4).

Similarly, pressing the "▼" key advances to the "channel voltage type" screen (see Section 3.2.1.2).

Pressing the "■" key advances to the "Channel Current Transformer Primary" mode.

Note: Changing CT primary value will reset all channel data.

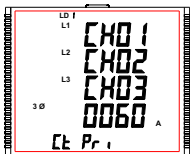

Pressing the "▲" key advances to the next "Channel Current Transformer Primary Value" screen (see Section 3.2.1.3).

Similarly, pressing the "▼" key advances to the previous "Channel Current Transformer Primary Value" Screen.

Pressing the "■" key advances to the "Channel Current Transformer Primary Digit Edit" mode.

Current Transformer Primary Digit Edit

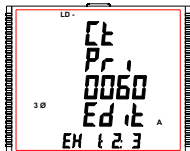

Pressing the "▲" or "▼" key scrolls the value of the most significant digit from 0 through 9 or 9 through 0, respectively (with digit roll over feature) unless the present displayed Current Transformer Primary Value together with the Potential Transformer Primary Value results in a maximum system power of greater than 5400 MVA (1800 MVA per phase) in which case the digit range gets restricted, the value will wrap.

Example: If primary value of PT is set as 1200 kVL-L (max value) then primary value of Current is restricted to 1804 A.

Pressing the "■" key accepts the present value at the cursor position and advances the cursor to the next less significant digit.

The "Maximum Power" restriction of 5400 MVA refers to 120% of nominal current and 120% of nominal voltage, i.e., 1250 MVA nominal power.

After entering the least significant digit, pressing the "■" key sets the value and advances to the "Pls Wait" screen followed by "Current Transformer Primary Value" screen (see Section 3.2.1.3).

Note: Default value is set to '60' i.e. 60A.

3.2.1.4 Quit Channel Parameters



This screen allows user to exit from Channel Parameter selection setup.

Pressing the "▲" key advances to "Channel mode" screen (see Section 3.2.1.1). Similarly, pressing the "▼" key advances to "Current Transformer Primary value" screen (see Section 3.2.1.3). Pressing the "■" key advances to "Channel Parameter Selection" screen (see Section 3.2.1).

3.2.2 System Parameter Selection

3.2.2.1 Potential Transformer Primary Value

The nominal full scale voltage is displayed as the **Line to Line** voltages for all channel mode. The values displayed represent the voltage in **kilovolts** (note “k” symbol).

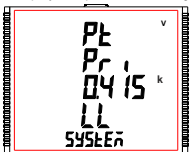

Pressing the “▲” key accepts the present value and advances to the “Potential Transformer Secondary Value” screen (see Section 3.2.2.2).

Similarly, pressing the “▼” key accepts the present value and advances to the “quit” screen (see Section 3.2.2.14).

Pressing the “=” key advances to the “Potential Transformer Primary Decimal Point Edit” mode.

Potential Transformer Primary Decimal Point Edit

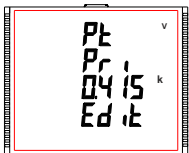

(Flashing decimal point indicates the cursor position). Initially the “decimal point must be selected, pressing the “▲” or “▼” key moves the decimal point position to the right until it disappears, which means that it has reached ####. after which it returns to #.###.

Note: The absence of decimal point in edit mode implies ####. decimal point position.

Pressing the “=” key accepts the present decimal point position and advances to the “Potential Transformer Primary Digit Edit” mode.

Potential Transformer Primary Digit Edit

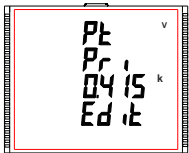

Pressing the “▲” or “▼” key scrolls the value of the most significant digit from 0 through 9 or 9 through to 0, respectively unless the present displayed Potential Transformer Primary Value together with the Current Transformer Primary Value, previously set, results in a maximum system power of greater than 5400 MVA (1800 MVA per phase) in which case the digit range gets restricted.

Pressing the “=” key accepts the present value at the cursor position and advances the cursor to the next less significant digit.

The PT Primary value can be set from 100 VL- L to 1200 kVL-L. The value will be forced to 100 VL-L if set less than 100.

Note: The flashing digit indicates the cursor position, a steady decimal point is present to identify the scaling of the number until the cursor position coincides with the steady decimal point position. At this stage the digit will flash.

When the least significant digit has been set, pressing the "■" key shows "Pls Wait" screen which is followed by the "Potential Transformer Primary Value" screen (see Section 3.2.2.1).

Note : PT Values must be set as Line to Line Voltage for Primary as Well as Secondary for all channel mode (3P3W/3P4W/1P2W).

The default value is '0.415 kVLL'.

3.2.2.2 Potential Transformer Secondary Value

The value must be set to the nominal full scale secondary voltage which will be obtained from the Transformer when the potential transformer (PT) primary is supplied with the voltage defined in 3.2.2.1 Potential Transformer Primary voltage. The ratio of full scale primary to full scale secondary is defined as the transformer ratio. The PT Secondary value can be set from 100VL-L to 600VL-L (according to input voltage range).

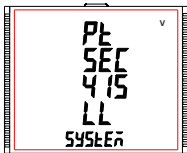

Pressing the "▲" key accepts the present value and advances to the "System frequency" screen (see Section 3.2.2.3).

Similarly, pressing the "▼" key accepts the present value and advances to the "Potential Transformer Primary Value" screen (see Section 3.2.2.1). Pressing the "■" key advances to the "Potential Transformer Secondary Digit Edit" mode.

Potential Transformer Secondary Digit Edit

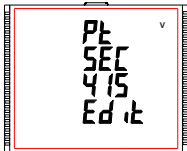

Pressing the "▲" or "▼" key scrolls the value of the most significant digit from 0 through 9 or 9 through 0, respectively.

Pressing the "■" key accepts the present value at the cursor position and advances the cursor to the next less significant digit.

After entering the least significant digit, pressing the "■" key sets the value and advances to the "Pls Wait" screen followed by the "Potential Transformer Secondary Value" screen (see Section 3.2.2.2).

The default value is 415 VLL.

Note: Changing PT Primary and PT Secondary will reset Energy, demand parameters, min volt, max volt and Load profile datalog.

3.2.2.3 System Frequency



This screen is used to set the frequency of the input. The Unit of displayed values is Hz.

Pressing the " " key enables editing and pressing the "▲" or "▼" key scrolls through the following Options: **50,60** Hz.

Once the desired option has been selected, pressing " " key confirms the selection and advances to the "System Frequency" menu (see Section 3.2.2.3).

Pressing the "▲" key advances to "Demand Integration Time" screen (see Section 3.2.2.4) and pressing the "▼" key advances to "Potential Transformer Secondary Value" screen (see Section 3.2.2.2).

- Note:** (1) The applied frequency and the entered frequency value should be same.
(2) Default value is set to '50' Hz.

3.2.2.4 Demand Integration Time

This screen is used to set the period over which current and power readings are to be integrated. The Unit of displayed values is **minutes**.

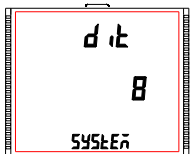

Pressing the " " key enables editing and pressing keys "▲" and "▼" allows scrolling through the following Options: **8,15,20,30**. Once the desired option is selected, pressing " " key confirms the selection and advances to "Pls Wait" screen followed by "Demand Integration Time" screen (see Section 3.2.2.4).

Pressing the "▲" key advances to "Auto Scrolling" screen (see Section 3.2.2.5) and pressing the "▼" key advances to "System Frequency" screen (see Section 3.2.2.3).

Note: Default value is set to '8' i.e. 8 min.
Changing Demand integration time will reset all the demand parameters.

3.2.2.5 Auto Scrolling



This screen allows user to enable screen scrolling.

Pressing "▲" key accepts the present status and advance to the "Low Current Noise Cutoff" screen (see Section 3.2.26). Similarly, pressing "▼" key accepts the present status and advances to the "Demand Integration Time" screen (see Section 3.2.2.4).

Pressing the "■" key allows editing and keys "▲" and "▼" allows the user to select either 'Yes' to enable autoscroll and 'No' to disable autoscroll.

Pressing "■" key selects the status displayed and advances to "Auto Scrolling" screen (see Section 3.2.2.5).

Note: Default value is set to 'NO'.

3.2.2.6 Noise Current Cutoff

This screen allows the user to set noise current cutoff in %.

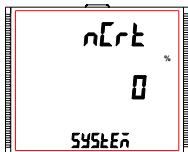

Pressing "▲" key accepts the present value and advance to "No. of Poles" screen (see Section 3.2.2.7). Similarly, pressing "▼" key accepts the present value and advance to "Auto Scrolling" screen (see Section 3.2.2.5).

Settable range is 0 to 5% of CT Primary value.

Pressing the "■" key allows editing and the user can select either 0,1,2,3,4 or 5 using "▲" and "▼" keys.

Pressing the "■" key confirms the selection and advances to "Noise Current Cutoff" screen (see Section 3.2.2.6).

Note: Default value is set as '0'.

3.2.2.7 No. of Poles

This screen enables to set No. of poles of a Generator of which RPM is to be measured and to which the instrument is connected to monitor its parameters.

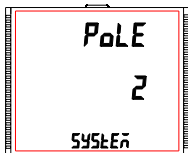

Pressing "▲" key accepts the present selection and advances to "Energy Output" menu (see Section 3.2.2.8). Similarly, pressing "▼" key accepts the present selection and advances to "Noise Current Cutoff" screen (See section 3.2.2.6).

Pressing the "■" key advances to editing mode for no. of poles and pressing "▲" and "▼" keys scrolls the number from 2 to 40 and 40 to 2, respectively in steps of 2.

Pressing the "■" key selects the status displayed and enter the "No. of Poles" menu (see Section 3.2.2.7).

Note: Default value is set to '2'.

3.2.2.8 Energy Output

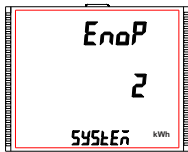

This screen enables user to set energy on modbus in terms of Wh / kWh / MWh as per the requirement . Same is applicable to all types of energy.

Pressing "▲" key accepts the presents value and advances to the "Energy Digit Reset Count" screen (see Section 3.2.2.9).

Similarly, pressing "▼" key accepts the present value and advances to the "No. of Poles" menu (see Section 3.2.2.7).

Pressing the "■" key will enter the editing mode for energy output and "▲" and "▼" keys scrolls through the values 1,2 & 3 and in the reverse order, respectively, with roll over feature:

1 : Energy in Wh 2 : Energy in kWh 3 : Energy in MWh

Pressing the "■" key sets the value selected and advances to "Pls Wait" screen followed by "Energy Output" menu (see Section 3.2.2.8).

Note: Changing the Energy unit results in the following :

- 1) Load Profile logging data gets reset.
- 2) Pulse Divisor (see Section 3.2.6.1.1.3), Topup Recharge for Tariff (see Section 3.2.8.1.1.3) and New Recharge for Tariff (3.2.8.1.1.4) may change accordingly.

- NOTE: 1. Default value is set to '2' i.e. Energy will be in terms of kWh/kVAh/kVAh respectively.
 2. If $(PT \text{ primary}(VLL) * CT \text{ primary} * \text{Root3}) > 30000 \text{ kW}$, then Energy Output can be set only as kWh and MWh.
 3. Energy on display is auto-ranging & so this setting is only applicable for modbus energy counters.
 (For Energy auto-ranging refer section 4.1)

3.2.2.9 Energy Digit Reset Count

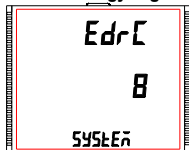

This screen enables user for setting maximum energy count after which energy on modbus will roll over to zero. User can select one of: **7,8,9**.

Pressing the "▲" key accepts the present value and will advance to the "Energy Rate" screen (see Section 3.2.2.10). Similarly, pressing the "▼" key accepts the present value and will advance to the "Energy Output" menu (see Section 3.2.2.8).

Pressing the "■" key advances to the Energy Digit Reset Count edit mode. Pressing the "▲" and "▼" key will scroll the value of reset count from 7 to 9 and 9 to 7, respectively with rollover feature.

Ex. If Energy Digit is set to 9 then energy on modbus will reset after "999,999,999" & rollback to zero and simultaneously the corresponding **Overflow count** value increases by 1.

Pressing "■" key sets the value selected and advances to "Pls Wait" screen followed by "Energy Digit Reset Count" screen (see Section 3.2.2.9).

Note:(1) Default value is set to '8' i.e. if energy count crosses 8 digits, then it will reset to zero.

- (2) Energy on Display is Auto-Ranging for details (for details see section 4.1)
- (3) Changing Edrc will reset energy and load profile log data.

3.2.2.10 Energy Rate

This screen allows user to enter energy update rate in minutes. After entering particular value in minutes, the energy will be updated on modbus location from 30685 to 30923 and 31337 to 31415 of 3X register and 40685 to 40923 and 41337 to 41415 of 4X register as per value that user has entered.

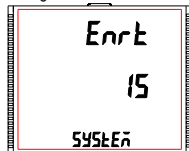

The user can select any integral value between **1 and 60** minutes.

Pressing the "▲" key accepts the present value and advances to "Impulse rate" screen (see Section 3.2.2.11).

Similarly, pressing the "▼" key accepts the present value and advances to "Energy Digit Reset Count" screen (see Section 3.2.2.9).

Pressing the " " key advances to the Energy Rate edit mode. Pressing "▲" and "▼" scrolls the count in minutes from 1 to 60 and from 60 to 1, respectively. **Ex.** If Energy Rate is set to 2 then energy will get stored after 2 minutes on the modbus.

Pressing " " key sets the value selected and advances to the "Energy Rate" menu (see Section 3.2.2.10).

Note: Default value is set to '15' i.e. 15 min.

3.2.2.11 Impulse Rate

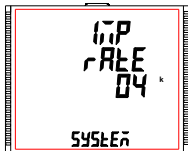

This screen shows user to Impulse rate depending upon the PT secondary and CT Secondary set by user.

'k' indicates value is multiplied by 1000.

Pressing the "▲" key advances to "quit" screen (see Section 3.2.2.12). Similarly, pressing the "▼" key advances to "Energy Rate" screen (see Section 3.2.2.10).

Nominal power	Impulse constant
<=80	16000
<=160	8000
<=320	4000
<=640	2000
>640	1000

1) CT Sec = 1

2) For Channel Energy :

$$\text{Nominal Power} = \text{PT Sec(LL)} \times \text{CT Sec} / 1.732$$

3) For System Energy :

$$\text{Nominal Power} = 3 \times \text{PT Sec(LL)} \times \text{CT Sec} / 1.732$$

3.2.2.12 Quit System Parameters

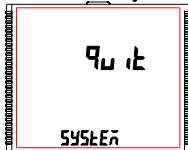

This screen allows user to Exit from System Parameter selection setup.

Pressing the "▲" key advances to "Potential Transformer Primary value" screen (see Section 3.2.2.1). Similarly, pressing the "▼" key advances to "Impulse rate" screen (see Section 3.2.2.11). Pressing the " " key advances to "System Parameter Selection" screen (see Section 3.2.2).

3.2.3 Communication Parameter Selection

3.2.3.1 Address Setting



This screen applies to the RS 485 output only. This screen allows the user to set RS 485 address for the meter.

The allowable range of addresses is 1 to 247.

Press "▲" key to advance to "RS 485 Baud Rate" screen (see Section 3.2.3.2) or press the "▼" key to advance to the "Quit Communication Parameters" screen (see Section 3.2.3.4).



Press "=" to enter into edit mode, prompt for first digit.

Press the "▲" and "▼" keys to scroll the value of the first digit. Press the "=" key to advance to next digit.

Similarly, enter second and third digits of address. After entering third digit, pressing "=" key confirms the selection and shows "Address Setting" screen (see Section 3.2.3.1).

The default setting is '1'.

3.2.3.2 RS 485 Baud Rate



This screen allows the user to set Baud Rate of RS 485 port. The values displayed on screen are in kbaud.

Pressing "▲" key accepts the present value and advance to the "RS 485 Parity Selection" screen (see Section 3.2.3.3) and pressing the "▼" key accepts the present value and advance to the "Address Setting" screen (see Section 3.2.3.1).

Pressing the "=" key advances to the "Baud Rate Edit" mode and "▲" & "▼" keys scrolls the value through **4.8**, **9.6**, **19.2**, **38.4** and **57.6** kbaud.

Pressing the "=" key sets the value and shows the "RS 485 Baud Rate" screen (see Section 3.2.3.2).

3.2.3.3 RS 485 Parity

This screen allows the user to set Parity & number of stop bits of RS 485 port.

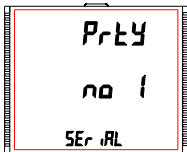

Pressing "▲" key accepts the present value and advances to "Quit Communication Parameters" screen (see section 3.2.3.4). Similarly, pressing "▼" key accepts the present value and advances to "RS 485 Baud Rate" screen (see section 3.2.3.2).

Pressing the "■" key advances to the "Parity & Stop bit Edit" mode & keys "▲" and "▼" scrolls the value through:

no 1 : no parity with one stop bit no 2 : no parity with two stop bit
E : even parity with one stop bit odd : odd parity with one stop bit

Pressing "■" key sets the value and advances to "RS 485 Parity Selection" screen (see Section 3.2.3.3).

Note: Default value is set as 'no 1'.

3.2.3.4 Quit Communication Parameters

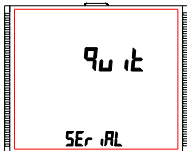

This screen allows user to exit from system "Communication Parameter Selection" setup.

Pressing the "▲" key advances to "Address setting" (see Section 3.2.3.1). Similarly, pressing the "▼" key advances to "RS 485 Parity" screen (see Section 3.2.3.3).

Pressing the "■" key advances to "Communication Parameter Selection" screen (see Section 3.2.3).

3.2.4 IP Parameter Selection

Note : For Ethernet connection set the Baud Rate (refer section 3.2.3.2) at 19.2kbps and insert the addon ethernet card.

3.2.4.1 IP Address Setting

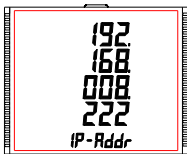

This screen allows the user to set Ip address.

Pressing "▼" key accepts the present value and advance to the "Quit IP parameters" screen (see Section 3.2.4.5) and pressing the "▲" key accepts the present value and advance to the "Subnet Mask Setting" screen (see Section 3.2.4.2).

Pressing the "▬" key advances to the "IP address Edit" mode

Pressing the "▬" key sets the value and shows the "IP address Edit Screen" (see Section 3.2.4.1).

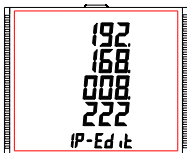

Pressing the "▲" or "▼" key scrolls the value of the most significant digit from 0 through 9 or 9 through 0, respectively

Pressing the "▬" key accepts the present value and advances the cursor to the next less significant digit.

user can set value from 000.000.000.000 to 255.255.255.255.

After entering the least significant digit, pressing the "▬" key sets the value

3.2.4.2 Subnet Mask Setting

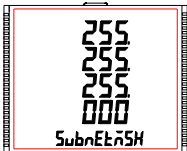

This screen allows the user to set Subnet Mask.

Pressing "▲" key accepts the present value and advance to the "Default gateway" screen (see Section 3.2.4.3) and pressing the "▼" key accepts the present value and advance to the "IP Setting" screen (see Section 3.2.4.1).

Pressing the "▬" key advances to the "Subnet Mask Edit" mode

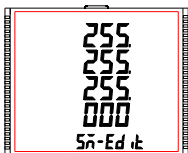

Pressing the "▲" or "▼" key scrolls the value of the most significant digit from 0 through 9 or 9 through 0, respectively
Pressing the "■" key accepts the present value at the cursor position and advances the cursor to the next less significant digit.
user can set value from 000.000.000.000 to 255.255.255.255.
After entering the least significant digit, pressing the "■" key sets the value.

3.2.4.3 Default Gateway Setting



This screen allows the user to set Default Gateway.
Pressing "▲" key accepts the present value and advance to the "Server port" screen (see Section 3.2.4.4) and pressing the "▼" key accepts the present value and advance to the "Subnet mask Setting" screen (see Section 3.2.4.2).

Pressing the "■" key advances to the "Default Gateway Edit" mode

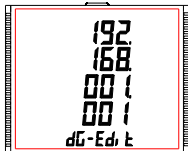

Pressing the "▲" or "▼" key scrolls the value of the most significant digit from 0 through 9 or 9 through 0, respectively
Pressing the "■" key accepts the present value at the cursor position and advances the cursor to the next less significant digit.
user can set value from 000.000.000.000 to 255.255.255.255.
After entering the least significant digit, pressing the "■" key sets the value.

3.2.4.4 Server Port Settings



This screen allows the user to set Server Port for the meter. The allowable range of addresses is 001 to 999.

Press "▼" key to advance to "Default Gateway" screen (see Section 3.2.4.3) or press the "▲" key to advance to the "Quit IP Parameters" screen (see Section 3.2.4.5).



Press "=" to enter into edit mode, prompt for first digit.

Press the "▲" and "▼" keys to scroll the value of the first digit. Press the "=" key to advance to next digit.

Similarly, enter second and third digits of address. After entering third digit, pressing "=" key confirms the selection and shows "Server Port Setting" screen (see Section 3.2.4.4).

The default setting is '502'.

3.2.4.5 Quit IP Parameters

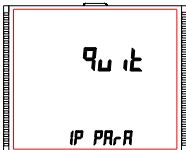

This screen allows user to exit from system "IP Communication Parameter Selection" setup.

Pressing the "▼" key advances to "Server Port Selection" screen (see Section 3.2.4.4). Similarly, pressing the "▲" key advances to "IP address Selection" screen (see Section 3.2.4.1).

Pressing the "=" key advances to "IP Parameter Selection" screen (see Section 3.2.4).

3.2.5 Reset Parameter Selection

3.2.5.1 Resetting Parameter

This screen allows the users to reset Energy, Lo(Min), hi(Max), Demand, Run hour, On hour, No. of Interrupts, Load Profile , Channel data and Time Datalog.

Reset Parameters



Reset (None)

Pressing "←" key advances to "Reset Parameters" screen.

Pressing the "▲" or "▼" key advances to "Reset Parameter Selection" screen (see section 3.2.4).

Pressing the "←" key advances to edit mode.

Edit mode

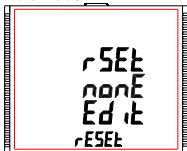

Pressing "▲" & "▼" keys scroll through the parameters given below:

ALL : reset all resettable parameters

onHr : reset on hour

inrt : reset no of auxiliary supply interruption count.

Hi - V : reset maximum values of volatge.

Lo - V : reset minimum values of voltage.

Hi - A : reset maximum value of current of selected channel.

Lo - A : reset minimum value of current of selected channel.

EnEr : reset energy of selected channel.

dmd : reset demand value of selected channel.

rnHr : reset run hour of selected channel.

CHnL : reset channel data of selected channel.

LoAd : reset load profile datalog buffers of selected channel.

tiME : reset the time based datalog buffer of selected channel.

Pressing the "←" key advances to "Pls Wait" screen and resets the parameter selected except "**Hi A** , **Lo - A** , **EnEr** , **dmd** , **rnHr** , **CHnL** and **LoAd**" parameter followed by "Reset Parameters" screen. These parameters have channel wise setting.

Pressing the "←" key advances to "Reset option" mode and pressing "▲" and "▼" keys advances to "Reset Parameter Selection" screen (see Section 3.2.5).

⚠ Caution : When Demand or Energy parameter are reset ,it will reset load profile log data.

For ex : resetting Hi - A (maximum current). Go to the reset parameter screen and select Hi - A

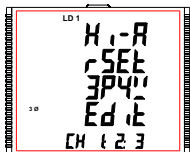

Pressing the " = " key advances to maximum current channel reset edit mode and pressing " ▲ " key will advance to select next channel of which maximum current is to reset and pressing " ▼ " key advances to previous channel.

Pressing the " = " key advances to "Pls Wait" screen and reset the parameter of selected channel.

Note : This setting is applicable for "Hi - A, Lo - A, EnEr, dmd, rnHr, Chnl, LoAd"

3.2.6. Output Option Selection

This screen applies to the relay output option selection. Pressing " " key advances to "Relay Selection" menu (see Section 3.2.6.1).

3.2.6.1 Relay Selection

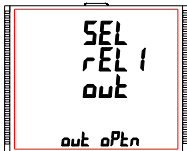

Pressing "▲" and "▼" keys scrolls through the following screens:

rEL1 : To select options for relay 1 (See section 3.2.6.1).

rEL2 : To select options for relay 2 (See section 3.2.6.1).

quit : To exit the Output Options menu and give the "Output Option Selection" screen (see Section 3.2.6).

Pressing " " key advances to Relay1 or 2 Output Selection menu (see Section 3.2.6.1.1).

3.2.6.1.1 Relay 1 or 2 Output Selection Menu

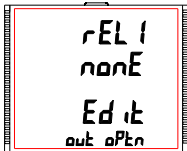

Pressing " " key makes the following options available for relay1 and relay2:

0 none : No parameter selected for relay output.

1. Pulse : Relay in Pulse output mode (see Section 3.2.6.1.1.1)

2. Limit : Relay in Limit output mode (see Section 3.2.6.1.1.2)

3. Timer : Relay in Timer output mode (see Section 3.2.6.1.1.3)

4. Load Health : Relay in load health mode (see Section 3.2.6.1.1.4)

5. Tariff Parameter : Relay in tariff mode (see Section 3.2.6.1.1.5)

6. RTC Relay : Relay in RTC output mode (see Section 3.2.6.1.1.6)

Press "▲" and "▼" keys to navigate between the above options and press " " key to confirm the selection.

The default option is set as 'none'.

3.2.6.1.1.1 Pulse Output



This screen is used to set the pulse output parameter.

Pressing "▲" key advances to "Parameter Selection" screen (see Section 3.2.6.1.1.1.1) whereas pressing "▼" key advances to "Quit Pulse Output" menu (see Section 3.2.6.1.1.1.4).

3.2.6.1.1.2 Limit Output

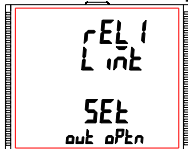

This screen is used to assign Relay in Limit output mode.

Pressing "▲" key shows "Parameter Selection" screen (see Section 3.2.6.1.1.2.1) where as pressing "▼" key shows the "Quit Limit Output" screen (see Section 3.2.6.1.1.2.10).

3.2.6.1.1.3 Timer



This screen is used to assign Relay in Timer output mode.

Pressing "▲" key will give the Number of Cycles menu (see Section 3.2.6.1.1.3.1) whereas pressing "▼" key gives the Quit Timer output menu (see Section 3.2.6.1.1.3.5).

3.2.6.1.1.4 Load Health



This screen is used to assign Relay in Load health output mode.

Pressing "▲" key advances to "Channel Selection" menu (see Section 3.2.6.1.1.4.1) whereas pressing "▼" key advances to "Quit Load health Output" menu (see Section 3.2.6.1.1.4.3).

3.2.6.1.1.5 Tariff

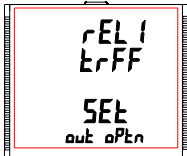

This screen is used to assign Relay in tariff output mode.

Pressing "▲" and "▼" key advances to "Quit Tariff Output" menu (see Section 3.2.6.1.1.5.1).

Note : If mode is changed from Tariff to any other, then the balance cost and balance energy will reset according to the top-up recharge.

3.2.6.1.1.6 RTC

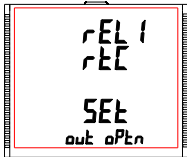

This screen is used to assign Relay in RTC output mode.

Pressing "▲" key advances to "Weekdays Selection" menu (see Section 3.2.6.1.1.6.1) where as pressing "▼" key advances to "Quit RTC Output" menu (see Section 3.2.6.1.1.6.5).

3.2.6.1.1.1 Parameter Selection



This screen allows the user to assign energy parameter for **pulse output**. Pressing "▲" key accepts the present setting and advance to "Pulse duration selection" (see section 3.2.6.1.1.2) and pressing "▼" key accepts the present setting and advance to "Quit Relay Output" selection (see section 3.2.6.1.1.4).

Pressing the "▬" key advances to edit mode and "▲" and "▼" keys scrolls through the energy parameter selection.

Edit mode

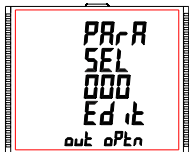

Pressing the "▲" key scrolls the value of from 0 to 80 and Pressing "▼" key scrolls the value from 80 to 0. Pressing "▬" keys sets the selected energy parameter and returns to "Parameter Selection" menu (see section 3.2.6.1.1.1).

Note: Default configuration is set as '000'.

3.2.6.1.1.2 Pulse Duration

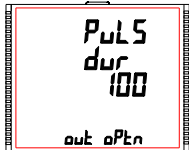

This screen applies only to the Pulse output mode of relay. This screen allows the user to set Relay energization time in milliseconds.

Pressing "▲" key accepts the present value and advance to "Pulse Rate" screen (see section 3.2.6.1.1.3). Similarly, pressing "▼" key accepts the present value and advance to "Parameter Selection" screen (see section 3.2.6.1.1.1).

Pressing the "▬" key advances to "Pulse Duration Edit" mode and "▲" and "▼" keys scroll the value through **60, 100 and 200** ms.

Pressing the "▬" key selects the value and advances to "Pulse Duration " menu (see Section 3.2.6.1.1.2).

Note: Default value is set to '100' ms.

3.2.6.1.1.1.3 Pulse Rate



This screen applies to the Pulse Output option only. The screen allows user to set the Energy Pulse Rate divisor. Divisor values can be selected through **1,10,100,1000** as per EnoP set. Refer **TABLE 2** for details.

Pressing "▲" key accepts the present selection and takes to the "Quit Pulse Output" menu (See section 3.2.6.1.1.1.4) and pressing "▼" key accepts the present selection and takes to the "Pulse Duration" screen (see Section 3.2.6.1.1.1.2).

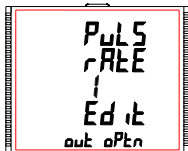

Pressing the "—" key advances to "Pulse Rate Divisor Edit" mode & keys "▲" and "▼" scrolls the value through the values 1,10,100 and 1000.

Pressing the "—" key gives the "Pulse Rate" screen (see Section 3.2.6.1.1.1.3).

The default setting is '1'.

Note: If energy resolution is in kWh or MWh then value is default 1.

3.2.6.1.1.1.4 Quit Pulse Output

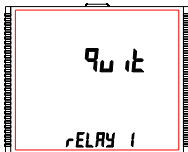

The screen allows user to exit the Pulse Output selection menu.

Pressing "▲" key advances to the "Pulse Output" menu (see Section 3.2.6.1.1.1) and pressing "▼" key advances to the "Pulse Rate" menu (See section 3.2.6.1.1.1.3).

Pressing "—" key advances to the "Relay Selection" menu (see Section 3.2.6.1.).

3.2.6.1.1.2.1 Limit Output Parameters

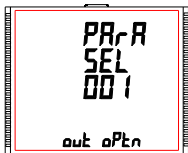

This screen is for **Limit output mode selection**. It allows the user to set Limit output corresponding measured value. Refer **TABLE 4** "Parameter for Limit output" for assignment.

Pressing "▲" key accepts the present parameter and for 79 to 138 and 581 to 600 as present value, advances to the "Energy Count Configuration" screen (see section 3.2.6.1.1.2.2) whereas for other values, advances to the "Parameter Configuration" screen (see Section 3.2.6.1.1.2.5). Whereas pressing "▼" key accepts the present parameter and advances to the "Quit Limit Output" screen (see section 3.2.6.1.1.2.10).

Pressing the "■" key advances to "Relay Output Selection" mode and "▲" and "▼" keys scrolls the values, as per **TABLE 4**, "Parameter for Limit Output".

Pressing the "■" key advances to "Limit Output Parameters" screen (see Section 3.2.6.1.1.2.1).

3.2.6.1.1.2.2 Energy Count Configuration



This screen is used to set the Limit Configuration for Energy Count.

Selecting 79 to 138 and 581 to 600 as Limit Output Parameter (see Section 3.2.5.1.1.2.1) allows the user select one of the following configurations:

En (To Energize the Relay)

d-En (To De-Energized the Relay)

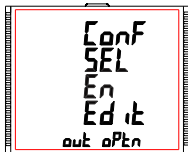

Pressing the "▲" key accepts the present selection and advances to the "Energy Trip Point" screen (see section 3.2.6.1.1.2.3) and pressing the "▼" key accepts the present selection and advances to the "Limit Output Parameters" screen (see section 3.2.6.1.1.2.1).

Pressing the "■" key advances to Energy Count Configuration edit mode and "▲" and "▼" keys scrolls through the modes available.

Pressing the "■" key sets the displayed value and advances to "Energy Count Configuration" Screen (see Section 3.2.6.1.1.2.2).

Note: Default configuration is set to 'En'.

3.2.6.1.1.2.3 Energy Trip Point

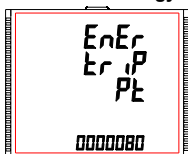

This screen is used to trip the relay using the energy count, whose unit depends on Energy output (see Section 3.2.2.8). The relay trips after the lapse of "ON Delay" time (see Section 3.2.6.1.1.2.4) from the moment the energy count reaches the value of Energy Trip Point set by the user in addition to its value at the moment the Energy Trip Point is set.

Pressing the "▲" key accepts the present value and advances to the "Energy Count ON Delay" screen (see Section 3.2.6.1.1.2.4) and pressing the "▼" key accepts the present value and advances to the "Energy Count Configuration" screen (see Section 3.2.6.1.1.2.2).

Pressing the "■" key advances to Energy Count Configuration edit mode.

Energy Count Configuration edit mode

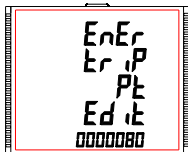

Press "■" key, prompt for the first digit.

Press the "▲" and "▼" keys to scroll the value between 0 and 9, whereas Press the "■" key to lock the present selection and advance to next digit.

Similarly, lock the value of all the remaining digits of the 7 digit count in a similar way until the last digit is reached.

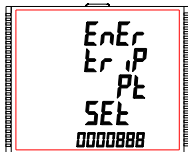

Pressing the "■" key for the last digit sets the value for Energy Trip Point.

For example, if the value set for Energy Trip Point is 888 and the value of the corresponding parameter at the moment this value is set is 1077, then the relay will trip after x sec of the moment the value of the parameter becomes $1077 + 888$, where x is the ON Delay (see Section 3.2.6.1.1.2.4). Trip value depends on Energy Output, e.g. If Energy output (see Section 3.2.2.8) is in Wh then the Energy trip point will be in Wh only i.e 888 Wh.

The value of Energy Trip Point can range from **10** to **9999999**. Default value is set to '10'.

⚠ Caution: Once the relay has tripped, then to reactivate the Energy Tripping function, the user has to either reset the energy or re-enter the energy count.

3.2.6.1.1.2.4 Energy Count ON Delay

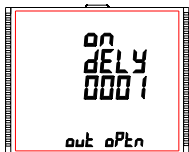

This screen allows the user to set ON Delay time in **seconds** for Relay Limit Assigned Parameter. Refer Section 3.2.6.1.1.2.3 for details.

Pressing "▲" key accepts the present value and advance to "Quit Limit Output" screen (see Section 3.2.6.1.1.2.10) and pressing "▼" key accepts the present value and advances to "Energy Trip Point" screen (see Section 3.2.6.1.1.2.3).

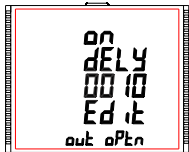

Press "=" key, prompt for the first digit.
Press the "▲" and "▼" keys to scroll the values of the first digit.
Press the "=" key to advance to next digit.

Similarly, enter second, third and fourth digits also.

After the fourth digit is entered, pressing "=" key sets the value and advances to "Energy Count ON Delay" screen (see Section 3.2.6.1.1.2.4).

The value for this parameter can range from 0001 to 9999 seconds.

Note: Default value is set to '1' second.

3.2.6.1.1.2.5 Parameter Configuration

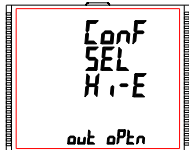

Selecting Limit Output Parameter (see Section 3.2.6.1.1.2.5) other than 79 to 138 and 581 to 600 allows the user select one of the following configurations:

- Hi - E (High Alarm & Energized Relay)
- Hi - d (High Alarm & De-Energized Relay)
- Lo - E (Low Alarm & Energized Relay)
- Lo - d (Low Alarm & De-Energized Relay)

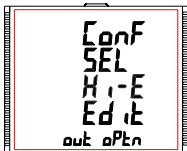

(For details refer to section 5.2)

Pressing the "▲" key accepts the present selection and advances to the "Trip Point" screen (see section 3.2.6.1.1.2.6) and pressing the "▼" key accepts the present selection and advances to the "Limit Output Parameters" screen (see section 3.2.6.1.1.2.1).

Pressing the "▬" key advances to Parameter Configuration edit mode and "▲" and "▼" keys scrolls through the modes available.

Pressing the "▬" key sets the selected config. and advances to "Limit Configuration" Screen (See section 3.2.6.1.1.2.5).

Note: Default configuration is set to 'Hi-E'.

3.2.6.1.1.2.6 Trip Point

This screen applies to the Trip point selection for parameters other than 79 to 138 and 581 to 600 selected in Section 3.2.6.1.1.2.1.

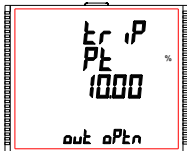

This screen allows the user to set Trip point for instruments.

The allowable range is **10% to 120% for High Alarm, 10% to 100% for Low Alarm** (refer TABLE 4).

Pressing the "▲" key accepts the present value and advances to the "Hysteresis" screen (see section 3.2.6.1.1.2.7) and pressing the "▼" key accepts the present value and advances to the "Parameter Configuration" screen (see Section 3.2.6.1.1.2.5).

Press "▬" to confirm and go to "Trip Point" screen (see Section 3.2.6.1.1.2.6).

(Flashing decimal point indicates the cursor position). Initially the "decimal point must be selected, pressing the "▲" or "▼" key moves the decimal point position to the right until it disappears, which means that it has reached ####. after which it returns to #.###.

Note: The absence of decimal point in edit mode implies ####. decimal point position.

Pressing the "▬" key accepts the present decimal point position and advances to first digit. Press the "▲" and "▼" keys to scroll the values of the first digit.

Press the "▬" key to advance to next digit. Similarly, enter second, third and fourth digits also.

Note: Default value is set to '10' %.

3.2.6.1.1.2.7 Hysteresis



This screen applies to the Hysteresis selection. This screen allows the user to set Hysteresis for relay output.

The allowable range is **0.5% to 50.0%** of Trip point.

Pressing the "▲" key accepts the present value and advances to the "Energizing Delay" screen (see Section 3.2.6.1.1.2.8) and pressing the "▼" key accepts the present value and advances to the "Trip Point" screen (see Section 3.2.6.1.1.2.6).

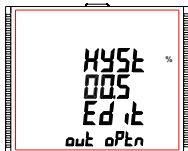

Pressing "—" key prompts for first digit.

Press the "▲" and "▼" key to scroll the value of the first digit.

Press the "—" key to advance to next digit.

The second digit prompts. Press "▲" and "▼" keys to scroll through 0 and 9 and "—" key to set the digit and advance to the third digit. The third digit prompts. Press "▲" and "▼" keys to scroll through 0 and 9.

Press "—" to confirm the value and advance to "Hysteresis" screen (see Section 3.2.6.1.1.2.7). Refer Section 5.2 for further details.

Note: Default value is set to '0.5' %.

3.2.6.1.1.2.8 Energizing Delay

This screen allows the user to set Energizing Delay time in **seconds** for Relay Limit Assigned Parameters.

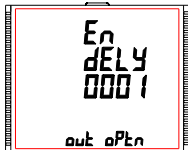

Pressing "▲" key accepts the present value and advances to "De-Energizing Delay" screen (see Section 3.2.6.1.1.2.9) and pressing "▼" key accepts the present value and advances to "Hysteresis" screen (see Section 3.2.6.1.1.2.7).

Pressing the "—" key advances to "Energizing Delay" Edit mode.

Pressing "—" key sets displayed value & advances to Assignment of "Energizing Delay" menu (See section 3.2.6.1.1.2.8).

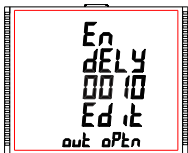

Pressing " " key prompts for first digit.

Press the "▲" and "▼" key to scroll the value of the first digit. Press the " " key to advance to second digit.

The second digit prompts. Press "▲" and "▼" keys to scroll through 0 and 9 and " " key to set the digit and advance to the third digit.

The third digit prompts. Press "▲" and "▼" keys to scroll through 0 and 9 and " " key to set the digit and advance to the fourth digit.

Press "▲" and "▼" keys to scroll through 0 and 9.

Press " " to confirm the value and advance to "Energizing Delay" screen (see Section 3.2.6.1.1.2.8).

The value of Energizing Delay can be set between **1 and 9999** seconds.

Note: Default value is set to '1' second.

3.2.6.1.1.2.9 De-Energizing Delay

This screen allows the user to set De-Energizing Delay time in **seconds** for Relay Limit Assigned Parameters.

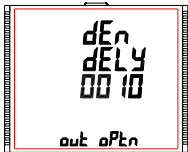

Pressing "▲" key accepts the present value takes to "Quit Limit Output" menu (See section 3.2.6.1.1.2.10).

Similarly, pressing "▼" key accepts the present value takes to "Energizing Delay" menu (See section 3.2.6.1.1.2.8).

Pressing the " " key advances to "De-Energizing Delay" Edit mode.

Pressing " " key sets displayed value and takes back to "De-Energizing Delay" screen (see Section 3.2.6.1.1.2.9).

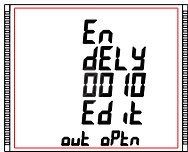

Pressing " " key prompts for first digit.

Press the "▲" and "▼" key to scroll the value of the first digit.

Press the " " key to advance to second digit.

The second digit prompts. Press "▲" and "▼" keys to scroll through 0 and 9 and " " key to set the digit and advance to the third digit.

The third digit prompts. Press "▲" and "▼" keys to scroll through 0 and 9 and " " key to set the digit and advance to the fourth digit.

Press "▲" and "▼" keys to scroll through 0 and 9.

Press " " key to confirm the value and advance to "De-Energizing Delay" screen (see Section 3.2.6.1.1.2.9).

The value of De-Energizing Delay can be set between **1 and 9999** seconds.

Note: Default value is set to '1' second.

3.2.6.1.1.2.10 Quit Limit Output

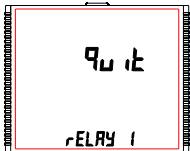

The screen allows user to exit the Relay output selection menu.

Pressing "▲" key advances to "Limit Output" menu (See section 3.2.6.1.1.2) and pressing "▼" key advances to "De-Energizing Delay" menu (see Section 3.2.6.1.1.2.9) if Limit Output Parameter (see Section 3.2.6.1.1.2.1) set is not 79 to 138 and 581 to 600, otherwise it advances to "Energy Count ON Delay" screen (see Section 3.2.6.1.1.2.4).

Pressing "■" key advances to "Relay Selection" menu (see Section 3.2.6.1).

3.2.6.1.1.3.1 Number of Cycles

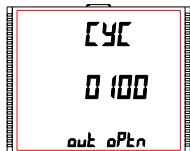

The value decides how many times the timer will repeat the switching after it has been started in the **timer based relay output option**.

Pressing "▲" key confirms the value and advances to the "Timer Configuration" menu (See section 3.2.6.1.1.3.2) and pressing "▼" key advances to "Timer" menu (See section 3.2.6.1.1.3).

The value for this **parameter can range from 0000 to 9999**.

If the value is set as 0000, the timer will keep repeating the cycles until 9999 cycles are complete or the timer is stopped by the user. Refer Section 5.3 for more details.

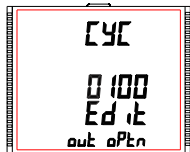

Press "■" key, prompt for the first digit.

Press the "▲" and "▼" keys to scroll the values of the first digit.

Press the "■" key to advance to next digit.

Similarly, enter second, third and fourth digits also.

After the fourth digit has been entered, pressing "■" key sets the value and advances to "Number of Cycles" screen (see Section 3.2.6.1.1.3.1).

The default setting is '10' cycles.

3.2.6.1.1.3.2 Timer Configuration

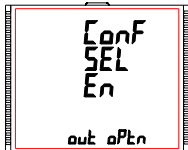

The option decides the relay configuration for timer output. Two options are available:

1. **En** : Energize on start
2. **d-En** : De-energize on start.

Pressing "▲" key confirms the selection and advances to the "On Delay" menu (See section 3.2.6.1.1.3.3) and pressing "▼" key advances to the "Number of Cycles" menu (See section 3.2.6.1.1.3.1).

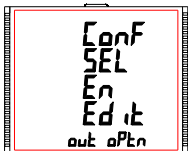

Press "▬" key to enter the edit mode and press "▲" and "▼" keys to navigate between the options.

Pressing "▬" key sets the selected config. and advances to the Timer Configuration menu (see Section 3.2.6.1.1.3.2).

The default setting is 'En'.

3.2.6.1.1.3.3 On Delay



The value decides the time in seconds taken by the relay in timer configuration before tripping after it is started.

Pressing "▲" key confirms the value and advances to the "Off Delay" menu (See section 3.2.6.1.1.3.4) and pressing "▼" key advances to the "Timer Configuration" menu (See section 3.2.6.1.1.2).

Press "▬" key, prompt for the first digit.

Press the "▲" and "▼" keys to scroll the values of the first digit.

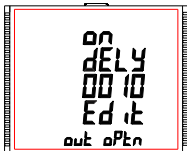

Press the " " key to advance to next digit.
Similarly, enter second, third and fourth digits also.
After the fourth digit is entered, pressing " " key sets the value and advances to "On Delay" screen (see Section 3.2.6.1.1.3.3).

The value for this **parameter can range from 0001 to 9999** seconds.
The default value is '10' seconds.

3.2.6.1.1.3.4 Off Delay



The value decides the time in seconds taken by the relay in timer configuration before coming out of the trip state after it has tripped.

Pressing "▲" key confirms the value and advances to the "Quit Timer Output" menu (See section 3.2.6.1.1.3.5) and pressing "▼" key advances to the "On Delay" menu (See section 3.2.6.1.1.3.3).

Press " " key, prompt for the first digit.
Press the "▲" and "▼" keys to scroll the values of the first digit.

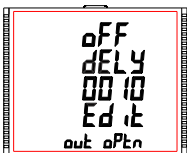

Press the " " key to advance to next digit.

Similarly, enter second, third and fourth digits also.
After the fourth digit has been entered, pressing " " key sets the value and advances to Off Delay screen (see Section 3.2.6.1.1.3.4).

The value for this parameter can range from **0001 to 9999** seconds.

The default value is '10' seconds.

3.2.6.1.1.3.5 Quit Timer Output

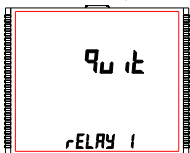

The screen allows user to exit the Timer output menu.

Pressing "▲" key advances to the "Timer Output" menu (see Section 3.2.5.1.1.3) and pressing "▼" key advances to "Off Delay" menu (see Section 3.2.5.1.1.3.4).

Pressing "■" key advances to "Relay Selection" menu (see Section 3.2.5.1).

3.2.6.1.1.4.1 Load Health Channel Selection



This screen is use to select channel for which Load health is to be monitored and settings are to be done. This is applicable only for 3 phase system only.

Pressing "▲" key advances to the "Configuration selection" menu (see Section 3.2.6.1.1.4.2) and "▼" key advances to "Load health" menu (see Section 3.2.6.1.1.4).

Channel selection Edit mode

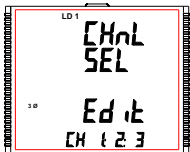

Press the "■" key to advance Channel Selection edit mode.

Pressing "▲" and "▼" key to scroll through the channel selection menu and pressing "■" key set the present channel for load health setting and advances to "Channel selection" menu (see Section 3.2.6.1.1.4.1).

3.2.6.1.1.4.2 Load Health Configuration

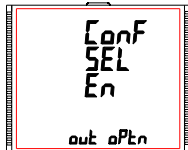

The option decides the relay configuration for Load health output. Two options are available:

1. **En** : Energize on start
2. **d-En** : De-energize on start.

Pressing "▲" key confirms the selection and advances to the "quit" menu (See section 3.2.6.1.1.4.3) and pressing "▼" key advances to the "Channel Selection" menu (See section 3.2.6.1.1.4.1).



Press "▬" key to enter the edit mode and press "▲" and "▼" keys to navigate between the options.

Pressing "▬" key sets the selected config. and advances to the Load health Configuration menu (see Section 3.2.6.1.1.4.2).

The default setting is 'En'.

3.2.6.1.1.4.3 Quit load health Output

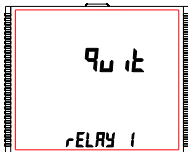

The screen allows user to exit the Load health output menu.

Pressing "▲" key advances to the "Load health" menu (see Section 3.2.5.1.1.4) and pressing "▼" key advances to "Configuration selection" menu (see Section 3.2.6.1.1.4.2).

Pressing "▬" key advances to "Relay Selection" menu (see Section 3.2.6.1).

3.2.6.1.1.6 RTC Relay

3.2.6.1.1.6.1 Weekdays Selection

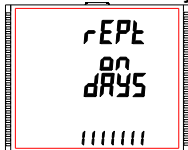

This screen allows user to select the days of the week on which the relay behaves as configured for RTC Relay settings.

Pressing "▲" key confirms the selection and advances to the "Relay Configuration" menu (See section 3.2.6.1.1.6.2) and pressing "▼" key advances to the "RTC Relay" menu (See section 3.2.6.1.1.6).

Pressing "▬" key advances user to the "Edit Weekdays" mode where the user can edit the working weekdays selection.

Edit Weekdays

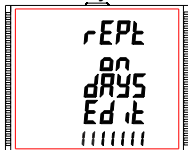

Press "▬" key, prompt for the first digit.

The first digit at the lower row of the screen represents SUNDAY. Press the "▲" and "▼" keys to scroll the value between 0 and 1, where
0 : Relay is not activated for the weekday selected
1 : Relay is active for the weekday selected.

Press the "▬" key to lock the present selection and advance to next digit representing MONDAY.



Lock the selection for all the remaining days, till selection for the last day, i.e., SATURDAY, is reached.

Once the selection for SATURDAY is set by pressing "▬" key, the "Weekdays Selection" screen appears again (see Section 3.2.6.1.1.6.1) and sets the days for relay to be active/deactive.

The default setting is '1111111' i.e., active for all the days.

3.2.6.1.1.6.2 Relay Configuration

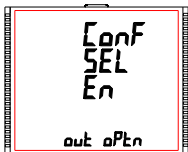

The option decides the relay configuration in RTC mode. Two options are available:

1. **En** : Energize on start
2. **d-En** : De-energize on start.

Pressing "▲" key confirms the selection and advances to the "On Time" menu (See section 3.2.6.1.1.6.3) and pressing "▼" key confirms the selection and advances to "Weekdays Selection" menu (see Section 3.2.6.1.1.6.1).

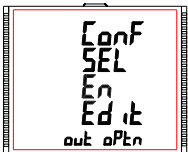

Press "▬" key to enter the edit mode and press "▲" and "▼" keys to navigate between the options.

Pressing "▬" key sets the selected option and advances to Relay Configuration menu (see Section 3.2.6.1.1.6.2).

The default setting is 'En', i.e., energized on start.

3.2.6.1.1.6.3 ON Time

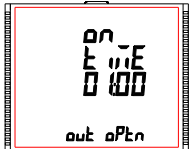

On Time is the time at which the relay becomes active. The time is displayed in HH:MM format and its **range is 00:00 to 23:59**.

Pressing "▲" key confirms the value and advances to the "OFF Time" menu (See section 3.2.6.1.1.6.4) and pressing "▼" key advances to the "Relay Configuration" menu (See section 3.2.6.1.1.6.2).

Pressing "▬" key advances to the Edit ON Time option.

Edit ON Time

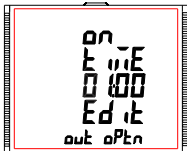

Press "←", prompt for 10's place of HH.
Press "→", prompt for 1's place of HH.
Press "←", prompt for 10's place of MM.
Press "→", prompt for 1's place of MM.

Keys "▲" and "▼" are used to change the corresponding values.

Pressing "↵" key confirms the selection and advances to the "ON Time" menu (see Section 3.2.6.1.1.6.3).
The default setting is '06:00', i.e., 6 A.M.

3.2.6.1.1.6.4 OFF Time

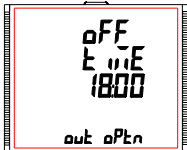

OFF Time is the time at which the relay deactivates.
The time is displayed in HH:MM format and its **range is 00:00 to 23:59**.

Pressing "▲" key confirms the value and advances to the "Quit RTC Output" menu (See section 3.2.6.1.1.6.5) and pressing "▼" key advances to the "ON Time" menu (See section 3.2.6.1.1.6.3).

Pressing "←" key advances to the "Edit OFF Time" option.

Edit OFF Time

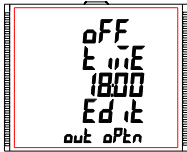

Press "←", prompt for 10's place of HH.
Press "→", prompt for 1's place of HH.
Press "←", prompt for 10's place of MM.
Press "→", prompt for 1's place of MM.

Keys "▲" and "▼" are used to change the corresponding values.

Pressing "↵" key confirms the selection and advances to the "OFF Time" menu (see Section 3.2.6.1.1.6.4).

The default setting is '18:00' i.e., 6 P.M.

3.2.6.1.1.6.5 Quit RTC Output

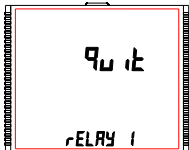

The screen allows user to exit the RTC output menu.

Pressing "▲" key advances to the "RTC Output" menu (see Section 3.2.6.1.1.6) and pressing "▼" key advances to the "OFF Time" menu (see Section 3.2.6.1.1.6.4).

Pressing "■" key advances to the "Relay Selection" (see Section 3.2.6.1).

3.2.7 Load Health Parameter

3.2.7.1 Unbalance Voltage Limit



This screen allows the user to set Trip point for instruments when the voltage is unbalance.

Pressing "▲" key accept the present value and advances to "Unbalance current limit" screen (see Section 3.2.7.2). Pressing "▼" key advances to "Load health Parameter" menu (see Section 3.2.7).

Pressing "■" key advances to Edit mode.

Edit mode

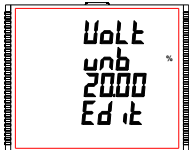

(Flashing decimal point indicates the cursor position). Initially the "decimal point must be selected, pressing the "▲" or "▼" key moves the decimal point position to the right until it disappears, which means that it has reached ####. after which it returns to #.###.

Pressing the "■" key accepts the present decimal point position and advances to first digit. Press the "▲" and "▼" keys to scroll the values of the first digit.

Press the "■" key to advance to next digit. Similarly, enter second, third and fourth digits also.

Value ranges from 5% to 20%

Note: Default value is set to 20%.

3.2.7.2 Unbalance Current Limit



This screen allows the user to set Trip point for instrument. when the Current is unbalance.

Pressing "▲" key accept the present value and advances to "Under Frequency limit" screen (see Section 3.2.7.3). Pressing "▼" key advances to "Unbalance voltage limit" screen (see Section 3.2.1).

Pressing "■" key advances to Edit mode.

Edit mode

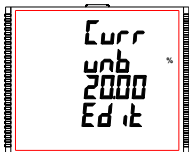

(Flashing decimal point indicates the cursor position). Initially the "decimal point must be selected, pressing the "▲" or "▼" key moves the decimal point position to the right until it disappears, which means that it has reached ###.#. after which it returns to #.###.

Pressing the "■" key accepts the present decimal point position and advances to first digit. Press the "▲" and "▼" keys to scroll the values of the first digit.

Press the "■" key to advance to next digit. Similarly, enter second, third and fourth digits also.

Value ranges from 5% to 20%

Setting Values as "0000" will disable this function.

Note: Default value is set to 20%.

3.2.7.3 Under Frequency Limit



This screen allows the user to set Trip point for instruments when the system frequency is under the tripping point.

Pressing "▲" key accept the present value and advances to "Under voltage limit" screen (see Section 3.2.7.4). Pressing "▼" key advances to "Unbalance Current limit" screen (see Section 3.2.7.2).

Pressing "■" key advances to Edit mode.

Edit mode



(Flashing decimal point indicates the cursor position). Initially the "decimal point must be selected, pressing the "▲" or "▼" key moves the decimal point position to the right until it disappears, which means that it has reached ####. after which it returns to #.###.

Pressing the "▬" key accepts the present decimal point position and advances to first digit. Press the "▲" and "▼" keys to scroll the values of the first digit.

Press the "▬" key to advance to next digit. Similarly, enter second, third and fourth digits also.

Value ranges from 95% to 99%

Setting Values as "0000" will disable this function

Note: Default value is set to 95%.

3.2.7.4 Under Voltage Limit



This screen allows the user to set Trip point for instruments when the input voltage is under the tripping point.

Pressing "▲" key accept the present value and advances to "over voltage limit" screen (see Section 3.2.7.5). Pressing "▼" key advances to "Under frequency limit" screen (see Section 3.2.7.3).

Pressing "▬" key advances to Edit mode.

Edit mode

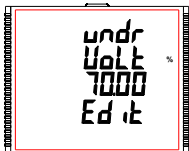

(Flashing decimal point indicates the cursor position). Initially the "decimal point must be selected, pressing the "▲" or "▼" key moves the decimal point position to the right until it disappears, which means that it has reached ####. after which it returns to #.###.

Pressing the "▬" key accepts the present decimal point position and advances to first digit. Press the "▲" and "▼" keys to scroll the values of the first digit.

Press the "▬" key to advance to next digit. Similarly, enter second, third and fourth digits also.

Value ranges from 70% to 90%

Setting Values as "0000" will disable this function

Note: Default value is set to 70%.

3.2.7.5 Over Voltage Limit



This screen allows the user to set Trip point for instruments. when the Nominal voltage is above the tripping point. Pressing "▲" key accept the present value and advances to "over current limit" screen (see Section 3.2.7.6). Pressing "▼" key advances to "Under Voltage limit" screen (see Section 3.2.7.4).

Pressing "■" key advances to Edit mode.

Edit mode

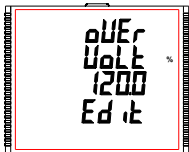

(Flashing decimal point indicates the cursor position). Initially the "decimal point must be selected, pressing the "▲" or "▼" key moves the decimal point position to the right until it disappears, which means that it has reached ###. after which it returns to #.###.

Pressing the "■" key accepts the present decimal point position and advances to first digit. Press the "▲" and "▼" keys to scroll the values of the first digit.

Press the "■" key to advance to next digit. Similarly, enter second, third and fourth digits also.

Value ranges from 110% to 120%

Setting Values as "0000" will disable this function

Note: Default value is set to 120%.

3.2.7.6 Over Current Limit



This screen allows the user to set Trip point for instruments. when the Nominal current of system is above the tripping point.

This screen is applicable only for 3 phase system. Pressing "▲" key will navigate through over current system screen. Only four system are allowed, so this screen will be either 4 or 3 or 2 or 1 depending upon how many 3phase systems are active.

Pressing "▲" key accept the present value and advances to "over current limit" screen of system 2 Pressing "▼" key advances to "Over Voltage limit" screen (see Section 3.2.7.5).

Pressing "■" key advances to Edit mode.

Edit mode

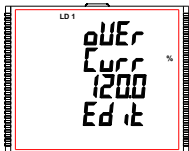

(Flashing decimal point indicates the cursor position). Initially the "decimal point must be selected, pressing the "▲" or "▼" key moves the decimal point position to the right until it disappears, which means that it has reached #####. after which it returns to #.###.

Pressing the "▬" key accepts the present decimal point position and advances to first digit. Press the "▲" and "▼" keys to scroll the values of the first digit.

Press the "▬" key to advance to next digit. Similarly, enter second, third and fourth digits also.

Value ranges from 50% to 120%

Setting Values as "0000" will disable this function

Note: Default value is set to 120%.

3.2.7.7 Quit Load Health

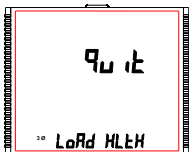

The screen allows user to exit the Load Health Parameter menu.

Pressing "▲" key advances to the "Unbalance Volatge limit" screen (see Section 3.2.7.1) and pressing "▼" key advances to the "Over current limit" screen (see Section 3.2.7.6).

Pressing "▬" key advances to the "Load health Parameter" menu (see Section 3.2.7).

3.2.8. Tariff Parameter Selection

This screen applies to the relay parameter selection for tariff mode (for details, refer Section 5.4). Pressing "▬" key advances to "Relay parameter Selection" menu (see Section 3.2.8.1).

3.2.8.1 Relay Selection



Pressing "▲" and "▼" keys scrolls through the following screens:

rEL1 : To select tariff parameter options for relay 1 (See section 3.2.8.1).

rEL2 : To select tariff parameter options for relay 2 (See section 3.2.8.1).

quit : To exit the Tariff relay selection menu and give the "tariff parameter Selection" menu (see Section 3.2.8).

Pressing "▬" key advances to Relay1 or 2 Parameter menu (see Section 3.2.8.1.1).

3.2.8.1.1 Relay 1 or 2 Parameters menu



Pressing " " key makes the following Parameters available for relay1 and relay2:

- 1 : Parameter selection
- 2 : Unit cost
- 3 : Topup recharge
- 4 : New recharge
- 5 : quit

Press "▲" and "▼" keys to navigate between the above Parameters and press " " key to enter into edit mode of the selected parameter.

Note : This parameters are available only when tariff is selected in the relay output options (see Section 3.2.6.1.1). Otherwise the relay in tariff selection are NC(Off).

3.2.8.1.1.1 Parameter Selection



This screen allows the user to assign energy parameter for tariff output. Pressing "▲" key accepts the present setting and advance to "Unit cost selection" (see section 3.2.8.1.1.2) and pressing "▼" key accepts the present setting and advance to "Quit Relay Output" selection (see section 3.2.8.1.1.5).

Pressing the " " key advances to edit mode and "▲" and "▼" keys scrolls through the energy parameter selection.

Edit mode



Pressing the "▲" key change the value from 0 to 80 and pressing "▼" key changes value from 80 to 0 of energy parameters & " " keys sets the selected energy parameter and returns to "Parameter Selection" menu (see section 3.2.8.1.1.1).

Note: Default configuration is set as '000' i.e. none.

3.2.8.1.1.2 Unit Cost



This screen allows the user to assign unit cost for the energy parameter. Pressing "▲" key accepts the present setting and advance to "Top up recharge" screen (see section 3.2.8.1.1.3) and pressing "▼" key accepts the present setting and advance to "Parameter Selection" screen (see section 3.2.8.1.1.1).

Pressing the "=" key advances to edit mode and "▲" and "▼" keys scrolls through the required cost.

Edit mode

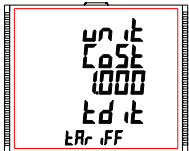

(Flashing decimal point indicates the cursor position). Initially the "decimal point must be selected, pressing the "▲" or "▼" key moves the decimal point position to the right until it disappears, which means that it has reached ####. after which it returns to #.###.

Note: The absence of decimal point in edit mode implies ####. decimal point position.

Pressing the "=" key accepts the present decimal point position and advances to first digit. Press the "▲" and "▼" keys to scroll the values of the first digit.

Press the "=" key to advance to next digit. Similarly, enter second, third and fourth digits also.

Unit cost ranges from 1 to 999.

Note: Default value is set to "1.000".

3.2.8.1.1.3 Topup Recharge



This screen allows the user to assign topup recharge for the energy parameter. Pressing "▲" key accepts the present setting and advance to "New recharge" screen (see section 3.2.8.1.1.4) and pressing "▼" key accepts the present setting and advance to "Unit cost" screen (see section 3.2.8.1.1.2).

Pressing the "=" key advances to edit mode and "▲" and "▼" keys scrolls through the required topup recharge.

Edit mode



Pressing the "←" key advances to the first digit position. Press the "▲" and "▼" keys to scroll the values of the first digit.

Press the "→" key to advance to next digit. Similarly, enter second, third until seventh digit..

Note: Default value is set to "100".

Note: Topup recharge range depends on Energy resolution unit(see Section 3.2.2.8)

1. When Energy resolution is "1", then topup recharge range will be from 1 to 9999.
2. When Energy resolution is "2 or 3", then topup recharge range will be from 1 to 9999999.

3.2.8.1.1.4 New Recharge

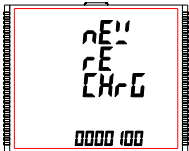

This screen allows the user to assign New recharge for the energy parameter. Pressing "▲" key accepts the present setting and advance to "quit" screen (see section 3.2.8.1.1.5) and pressing "▼" key accepts the present setting and advance to "Topup recharge" screen (see section 3.2.8.1.1.3).

Pressing the "←" key advances to edit mode and "▲" and "▼" keys scrolls through the required New recharge.

Edit mode

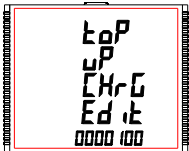

Pressing the "←" key advances to the first digit position. Press the "▲" and "▼" keys to scroll the values of the first digit.

Press the "→" key to advance to next digit. Similarly, enter second, third until seventh digit..

Note: Default value is set to "100".

Note: New recharge range depends on Energy resolution unit(see Section 3.2.2.8)

1. When Energy resolution is "1", then New recharge range will be from 1 to 9999.
2. When Energy resolution is "2 or 3", then New recharge range will be from 1 to 9999999.

3.2.8.1.1.5 Quit for tariff

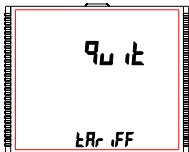

The screen allows user to exit the Tariff Relay Parameter menu.

Pressing "▲" key advances to the "Parameter selection" screen (see Section 3.2.8.1.1.1) and pressing "▼" key advances to the "New recharge" screen (see Section 3.2.8.1.1.2).

Pressing "■" key advances to the "Tariff Relay Parameter" menu (see Section 3.2.8.1).

3.2.9 Datalog Option Selection

3.2.9.1 Event Based Datalog Setup



This screen is used to enter into event datalogging feature.

Pressing the "▲" key advances to the "Time Based Datalog" menu (see Section 3.2.9.2) and pressing the "▼" key takes to the "Quit Datalog Option" menu (see Section 3.2.9.4).

Pressing the "■" key advances to the Event Based datalog selection and pressing the "▲" and "▼" key scrolls through the options available:

datalog : YES/no (see Section 3.2.9.1.1)

quit : to exit Event Datalog Selection (see Section 3.2.9.1.2)

3.2.9.1.1 Event Based Datalog Selection



This screen is used to start or stop event datalogging.

Pressing the "■" key allows the user to start or stop event based datalogging by selecting "YES" or "no", respectively using "▲" and "▼" keys.

Once the required option is selected, pressing the "■" key sets the selection and advances to the Event Based Datalog selection screen (see Section 3.2.9.1.1).

3.2.9.1.2 Quit Event Datalog

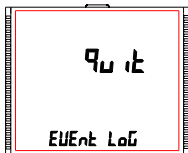

This screen is used to exit event based datalog selection.

Pressing the "←" key advances to the Event Based Datalog setup screen (see Section 3.2.9.1).

3.2.9.2 Time Based Datalog Setup



This screen is used to enter into time based datalog feature.

Pressing the "▲" key takes to the "Load Profile Datalog" menu (see section 3.2.9.3) and pressing the "▼" key takes to the "Event Based Datalog" menu (see section 3.2.9.1).

Pressing the "←" key advances to Time Based datalog selection and pressing "▲" and "▼" keys scrolls through various parameters related to time based datalogging (see Section 3.2.9.2.1 to Section 3.2.9.2.5).

3.2.9.2.1 Time Based Datalog Selection



This screen is used to start or stop time based datalogging.

Pressing the "▲" key confirms the selection and advances to "Time Interval Selection" screen (see Section 3.2.9.2.2) and pressing the "▼" key confirms the selection and advances to "Quit Time Based Logging" screen (see Section 3.2.9.2.5).

Pressing the "←" key allows the user to start or stop time based datalogging by selecting "YES" or "no", respectively using "▲" and "▼" keys.

Pressing the "←" key sets the selection and if the selection is "YES", then "Pls Wait" screen appears followed by "Time Based Datalog Selection" screen (see Section 3.2.9.2.1).

- ⚠ Caution:**
- 1) The settings for time based logging (see Section 3.2.9.2.2 - Section 3.2.9.2.4) are not editable if time based datalog selection is set to YES (see Section 3.2.9.2.1).
 - 2) Turning on the time based datalog will erase all the previous data.

3.2.9.2.2 Time Interval Selection

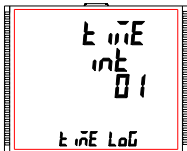

This screen is used to decide the time interval between two successive time datalog entries.

The allowable range is 01 - 60 minutes.

Pressing the "▲" key confirms the selection and advances to "Parameter Count" screen (see Section 3.2.9.2.3) and pressing the "▼" key confirms the selection and advances to "Time Based Datalog Selection" screen (see Section 3.2.9.2.1).

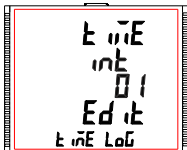

Press "■" to enter different time interval, it prompts for first digit.

Press the "▲" and "▼" keys to scroll the value of the first digit. Press the "■" key to advance to next digit.

Similarly, enter the second digit of interval.

After entering second digit, pressing "■" key sets the value and advances to the "Time Interval Selection" screen (see Section 3.2.9.2.2).

The default value is '1' minute.

3.2.9.2.3 Parameter Count



This screen is used to decide the number of parameters that will be logged in time based datalogging.

The allowable range is 1 - 120.

Pressing the "▲" key confirms the selection and advances to "Parameter Selection" screen (see Section 3.2.9.2.4) and pressing the "▼" key confirms the selection and advances to "Time Interval Selection" screen (see Section 3.2.9.2.2).

Press "■" key, prompt for the first digit.

Press the "▲" or "▼" key to scroll the values of the first digit.

Press the "■" key to advance to next digit.

Similarly, enter second and third digits also.

After the third digit has been entered, pressing "■" key sets the value and advances to "Parameter Count" screen (see Section 3.2.9.3).

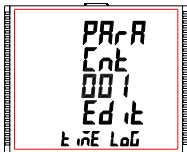

Press " " to enter the parameter count, prompt for first digit.

Press the "▲" and "▼" keys to scroll the value of the first digit. Press the " " key to advance to next digit.

Similarly, enter the second and third digits of interval. After entering third digit, pressing " " key sets the value and advances to the "Parameter Count" screen (see Section 3.2.9.2.3).

The default value is '1'.

3.2.9.2.4 Parameter Selection

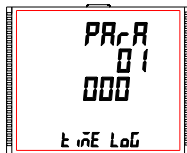

This screen is used to select the measurement parameters to be recorded. The allowable values are shown in Table 4.

For each of the parameter count set in Section 3.2.9.2.3, the corresponding parameter number (**Refer Table 5**) can be set by the user.

Pressing "▲" key confirms the selection and allows the user to proceed for setting the next parameter until the last parameter is set which is followed by the "Quit Time Based Datalog" screen (see Section 3.2.9.2.5).

Where as pressing the "▼" key confirms the selection and takes to the previous parameter set until the first parameter is reached which is followed by the "Parameter Count" screen (see Section 3.2.9.2.3).

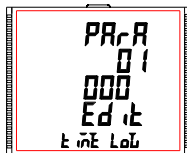

Press " " to enter the parameter selection.

Press the "▲" and "▼" keys to scroll the value of the measurement parameter number in decreasing and increasing order, respectively.

Pressing " " key sets the value and take user to the "Parameter Selection" screen (see Section 3.2.9.2.4) for the parameter set.

The default value is '000', i.e. no parameter to be logged.

3.2.9.2.5 Quit Time Based Datalog

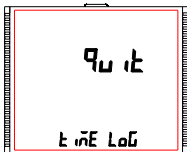

This screen is used to exit time based datalog selection.

Pressing the "←" key advances to the "Time Based Datalog Setup" screen (see Section 3.2.9.2).

3.2.9.3 Load Profile Datalog Setup



This screen is used to enter into Load Profile datalog feature.

Pressing the "▲" key takes to the "Quit Datalog Option" menu (see Section 3.2.9.4) and pressing the "▼" key advances to "Time Based Datalog Setup" (see Section 3.2.9.2).

Pressing the "←" key advances to the Load Profile datalog Channel selection and pressing the "▲" and "▼" key scrolls through the options available:

datalog : YES/no (see Section 3.2.9.3.1)

quit : to exit Load Profile Datalog selection (see Section 3.2.9.3.2).

Note: Load Profile datalogging selection depends upon what channel mode is set of particular channel.

3.2.9.3.1 Load Profile Datalog Selection

This screen is used to start or stop Load Profile datalogging for particular channel based on the channel mode of that channel.

Load Profile Datalog Selection for 3P4W / 3P3W



Consider a 3P4W system at channel 1,2,3.

Pressing the " " key allows the user to start or stop Load Profile datalogging by selecting "YES" or "no", respectively of selected three phase system using "▲" and "▼" keys.

Pressing the " " key sets the selection and if the selection is "YES", then "Pls Wait" screen appears followed by "Load Profile Datalog Selection" screen (see Section 3.2.9.3.1.2). If the selection is "no", then "Pls Wait" screen does not appear.

3.2.9.3.2 Quit Load Profile Datalog Selection

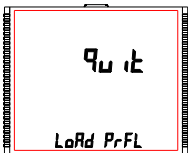

This screen is used to exit Load Profile datalog selection.

Pressing the " " key advances to the "Load Profile Datalog Setup" screen (see Section 3.2.9.3).

3.2.9.4 Quit Datalog Option

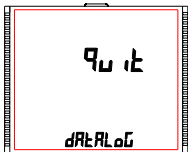

The screen allows user to exit the Datalog Option menu.

Pressing "▲" key advances to the "Event Based Datalog" menu (see Section 3.2.9.1) and pressing "▼" key advances to the "Load Profile Datalog Setup" menu (see Section 3.2.9.3).

Pressing " " key advances to the "Datalog Option Selection Menu" (see Section 3.2.9).

3.2.10 Display Parameters

3.2.10.1 Feature Selection Menu



This menu allows the user to scroll through different Display Configurable features:

bCLt : backlit on/off

Scrn : user screen on/off

Cont : Contrast level



quit : to exit Display Parameters screen





Pressing the "  " key advances to the listed features (see Section 3.2.10.1.1 to Section 3.2.10.1.3).

3.2.10.1.1 Backlit







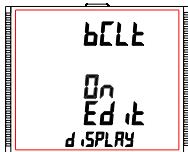

This screen allows the user to switch the backlit on or off.

Pressing the "  " and "  " keys advances to "User Assignable Screens" (see Section 3.2.10.1.2) and "Quit Display Parameters" menu (see Section 3.2.10.1.4), respectively.

Pressing the "  " key shows the present status as on/OFF and pressing "  " key allows editing it whereas "  " and "  " keys advance to the "Backlit" menu (see Section 3.2.10.1.1).



In Edit Mode, pressing "  " and "  " keys allows the user to scroll between On/OFF and pressing "  " key confirms the selection.

Pressing "  " key again advances to editing mode whereas pressing "  " or "  " keys advances to "Backlit" menu (see Section 3.2.10.1.1).

Note: When backlit is switched 'Off', on pressing any key backlit will turn 'On' for 1 min.

Default value is set to 'On'.

3.2.10.1.2 User Assignable Screens



This screen allows the user to turn enable or disable the User Screen feature.

Using this feature, the user can select upto 40 measurement screens of his choice and scroll through only those selected screens.

Pressing the "←" key allows the user to advance to the "Screen Number Selection" menu (see Section 3.2.10.1.2.1) whereas pressing the "▲" and "▼" keys advances to "Backlit" menu (see Section 3.2.10.1.3) and "Contrast" menu (see Section 3.2.10.1.1), respectively.

3.2.10.1.2.1 Screen Number Selection

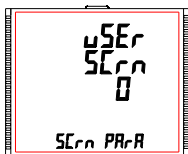

Pressing the "▲" key sets the present value for the number of screens to be shown and advance towards the "User Screens Selection" menu (see Section 3.2.10.1.2.2) whereas pressing the "▼" key sets the present value and advance to "Quit Userscreens" menu (see Section 3.2.10.1.2.3).

Pressing "←" key allow the user to set a different value for the number of user assignable screens using "▲" and "▼" keys.

The user can set the number of screens from **1 to 40**.

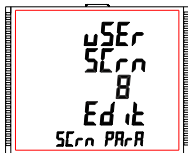

Pressing "←" key sets the selected value and advances to "Screen Number Selection" screen (see Section 3.2.10.1.2.1).

- Note:** 1. The value 0 should be chosen if the user wants all the screens to be shown.
2. If User Screen feature is ON and channel mode is changed, then the Userscreen is disabled.

The default setting is '0', i.e., all screens are shown.

3.2.10.1.2.2 User Screens Selection

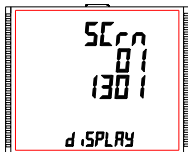

Pressing the "▲" key confirms the selection and allows the user to proceed for setting the next userscreen until the last userscreen is set which is followed by the "Quit UserScreens" menu (see Section 3.2.10.1.2.3).

Whereas pressing the "▼" key confirms the selection and take to the previous userscreen set until the first userscreen is reached which is followed by the "Screen Number Selection" screen (see Section 3.2.10.1.2.1).

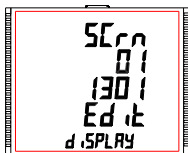

Pressing the "=" key advances the User Screen Edit mode and pressing "▲" and "▼" keys scroll the value as per TABLE 1.1 "Measurement Screens".

Pressing "=" key sets the displayed value & advance to User Screen Selection (see Section 3.2.10.1.2.2) for the corresponding screen number.

3.2.10.1.2.3 Quit Userscreens

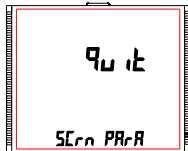

This screen is used to exit User defined Screen selection.

Pressing the "=" key advances to the "User Assignable Screens" menu (see Section 3.2.10.1.2).

3.2.10.1.3 Contrast



This screen allows the user to set the contrast for the display.

Pressing the "▲" and "▼" keys advances to "Quit Display" menu (see Section 3.2.10.1.4) and "User Assignable Screens" menu (see Section 3.2.10.1.2), respectively.

Pressing the "■" key shows the present contrast value and pressing "■" key again will allow editing it whereas "▲" and "▼" keys advances to the "Contrast" menu (see Section 3.2.10.1.3).

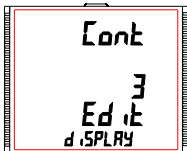

In Edit Mode, pressing "▲" and "▼" keys allows the user to scroll between **contrast levels ranging from 1 to 4** and pressing "■" key confirms the selection.

Pressing "■" key advances to editing mode whereas pressing "▲" or "▼" keys advances to the "Contrast" menu (see Section 3.2.10.1.3). Default value is set to '3'.

3.2.10.4 Quit Display Parameters

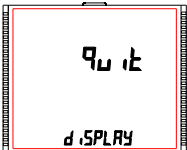

This screen allows user to Exit from Display Parameter selection setup.

Pressing the "▲" key advances to "Backlit" screen. (see Section 3.2.10.1.1). Whereas pressing the "▼" key advances to "Contrast" screen. (see Section 3.2.10.1.3).

Pressing the "■" key advances to "Display Parameters" (see Section 3.2.10).

3.2.11 RTC Setting Screen

3.2.11.1 Date Setting Screen



This screen allows the user to set date for the device RTC.

Pressing " " advances to Date Settings (see Section 3.2.11.1) and pressing "▲" and "▼" keys advances to Time Settings (see Section 3.2.11.2) and "Quit RTC" screen (see Section 3.2.11.3), respectively.

Edit mode

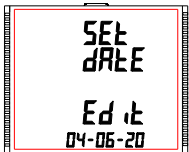

This screen allows the user to set the date for device RTC. The date is displayed in DD-MM-YY format in the settings and its **range is 01-01-00 to 31-12-99** (for the 21st century, i.e., YY = 00 represents 2000 and YY = 99 represents 2099).

Press " ", prompt for DD.

Press " ", prompt for MM.

Press " ", prompt for YY.

Keys "▲" and "▼" are used to change the values of DD, MM and YY. After YY is set, pressing " " advances to "Pls Wait" screen followed by "Date Settings" screen (see Section 3.2.11.1).

⚠ Caution : If date setting is changed then load profile log data will reset.

3.2.11.2 Time Settings

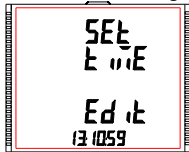

This screen allows the user to set the time for device RTC.

The date is displayed in HH:MM:SS format in the settings and its **range is 00:00:00 to 23:59:59**.

Press " ", prompt for 10's place of HH.

Press " ", prompt for 1's place of HH.

Press " ", prompt for 10's place of MM.

Press " ", prompt for 1's place of MM.

Press " ", prompt for 1's place of SS

Press " ", prompt for 1's place of SS

Keys "▲" and "▼" are used to change the corresponding values.

After 1's place of SS is set, pressing " " advances to "Time Settings" screen (see Section 3.2.11.2).

3.2.11.3 Quit RTC

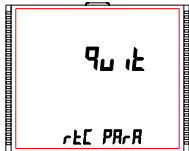

This screen allows user to Exit from RTC settings.

Pressing the "▲" key advances to "Date Settings" screen. (see Section 3.2.11.1). Whereas pressing the "▼" key advances to "Time Settings" screen (see Section 3.2.11.2).

Pressing the "■" key advances to "RTC Setting screen" (see Section 3.2.11).

3.2.12 Display Diagnosis Parameter

3.2.12.1 Firmware version

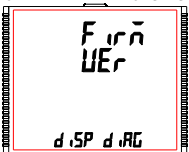

This screen allows the user to watch the current firmware version of instrument.

Pressing "▲" key advances to "All segment glow" screen (see Section 3.2.12.2) and pressing "▼" key advances to "quit" screen (see Section 3.2.12.3).

Pressing "■" key advances to "Firmware version" screen (see Section 3.2.12.1)

3.2.12.1.1

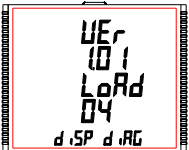

This screen display the firmware verison and how many load does instrument has.

Pressing "▲", "▼" and "■" key advances to "Firmware version" screen (see Section 3.2.12.1)

3.2.13 Factory Reset



This screen allows the user to set the meter to its Factory Default settings (see Section 3.2.13).

Pressing the "▲" key advances to "Quit Setup" screen (see Section 3.2.14) and pressing "▼" key advances to "Display diagnosis" screen (see Section 3.2.12).

3.2.13.1 Factory Reset Screen

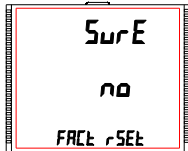

This screen allows the user to erase all data from the meter and set all setup parameters to their default values.

Pressing the "■" key advances to the "Sure" (confirmation) screen which displays a "no".

Pressing "▲" or "▼" key advances to Factory Reset Screen (see Section 3.2.13).

Whereas pressing "■" key advances to the Factory Reset selection screen.

Factory Reset selection screen

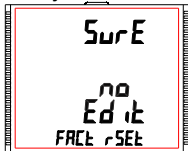

Pressing "▲" or "▼" key allows the user to select between "YES" or "no".

YES : Allow Factory Reset

no : Don't allow Factory Reset

Pressing "■" accepts the selection and if the selection is "YES", advances to "Pls Wait" screen followed by the "Sure" screen of "Factory Reset Screen" (see Section 3.2.13). If the selection is "no", then "Pls Wait" screen does not appear.

3.2.14 Quit

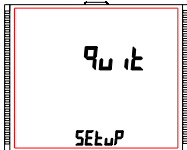

This screen allows the user to set the meter to exit the setup menu.

Pressing " = " key quits from the Setup menu and advance to measurement screen at which the setup screen was accessed.

4. Energy Auto-Ranging On Display :

4.1 Calculating Display energy (Auto-ranging):

In case of energy auto-ranging the energy shown on modbus will be in terms of Overflow count (OF) & main energy counter (M) based on energy resolution & energy digit reset count (EDRC). So energy on modbus will have unit set in energy resolution on modbus (ie. Wh or kWh or MWh) & overflow energy counter (OF) on modbus will increment when main energy counter (M) on modbus will cross the number of digits set in energy digit reset count (EDRC) register (ie 7 or 8 or 9).

Whereas energy shown on display will be Combined energy (ie. Calculated from overflow count (OF) on modbus & main energy Count (M) on modbus) autoranged based on the 9 digits available on display to show energy.

Hence the purpose of this document is to establish a relation between modbus energy counters & display energy.

$$\text{Total Energy} = \text{OF} \times 10^{\text{EDRC}} + \text{M}$$

Where:

OF => Overflow Count on modbus

Modbus registers for Overflow count (OF) for Channel Energies :

Wh import Overflow count Channel 1 to 12 => 30277 to 30299 Or 40277 to 40299

Wh export Overflow count Channel 1 to 12 => 30301 to 30323 Or 40301 to 40423

VARh Capacitive Overflow count Channel 1 to 12 => 30325 to 30347 Or 40325 to 40347

VARh Inductive Overflow count Channel 1 to 12 => 30349 to 30371 Or 40349 to 40371

Vah Overflow count Channel 1 to 12 => 30373 to 30395 Or 40373 to 40395

Modbus registers for Overflow count (OF) for System Energies :

Wh import Overflow count System 1 to 4 => 31201 to 31207 Or 41201 to 41207
Wh export Overflow count System 1 to 4 => 31209 to 31215 or 41209 to 41215
VARh Capacitive Overflow count System 1 to 4 => 31217 to 31223 or 41217 to 41223
VARh Inductive Overflow count System 1 to 4 => 31225 to 31231 or 41225 to 41231
Vah Overflow count System 1 to 4 => 31233 to 31239 or 41233 to 41239

M => Main Energy Counter on modbus

Modbus registers for Main energy Count (M) for Channel Energies:

Wh import Channel 1 to 12 => 30155 to 30179 or 40155 to 40179
Wh export Channel 1 to 12 => 30181 to 30203 or 40181 to 40203
VARh Capacitive Channel 1 to 12 => 30205 to 30227 or 40205 to 40227
VARh Inductive Channel 1 to 12 => 30229 to 30251 or 40229 to 40251
Vah Channel 1 to 12 => 30253 to 40275 or 40253 to 40275

Modbus registers for Main energy Count (M) for System Energies:

Wh import System 1 to 4 => 31161 to 31167 or 41161 to 41167
Wh export System 1 to 4 => 31169 to 31175 or 41169 to 41175
VARh Capacitive System 1 to 4 => 31177 to 31183 or 41177 to 41183
VARh Inductive System 1 to 4 => 31185 to 31191 or 41185 or 41191
Vah System 1 to 4 => 31193 to 91199 or 41193 to 41199

EDRC => Energy digit reset count set by user from display or modbus
For display setting refer Section 3.2.2.9.
For modbus refer Register 46093

Example for Calculating Display Energy from modbus Energy Counters:

Energy resolution on modbus register 46091 is set to 2 (ie. It will measure energy in kWh).

Overflow count (OF) value on modbus register 30277 for watt Import is 25.

Energy main counter (M) value on modbus register 30155 for watt import is 2587413.189

Energy digit reset count (EDRC) set by user in modbus register 46093 is 8.

Then,

$$\begin{aligned}\text{Total Energy} &= 25 \times 10^8 + 2587413.189 \\ &= 2500000000 + 2587413.189 \\ &= 2502587413.189 \text{ kWh}\end{aligned}$$

Therefore Energy shown on display will be:
= 2502587.41 MWh

As maximum number of digits for displaying energy present on display is 9 and the value of Total Energy in above example exceeds 9 counts so Energy in kWh is converted to MWh for displaying as shown above.

Note: As maximum energy shown on the display is XXXXXXXXX (9 Count) GWh so if count of above calculation for Total energy exceeds XXXXXXXXX (9 Count) GWh then the display will show "----oF---" with unit GWh that indicates display energy has overflowed. This condition will only get reset if the Total Energy Count gets reset.

Overflow count (OF) on modbus will reset to 0 if it exceeds 99999999 in case of Wh resolution, 99999 in case of kWh resolution & 99 in case of Mwh resolution.

4.2 Entering Energy start count:

(Applicable for meter with modbus or Ethernet)

Energy start count is the feature that allows user to set count from which the meter should start incrementing energy. The start count can be set for main energy start counter & Overflow energy start Counter separately from modbus or Ethernet. Setting of energy start count is dependent on Energy resolution & Energy digit reset count (EDRC).

Energy resolution on modbus can be set by user from display (Refer section 3.2.2.8 of user manual) or from modbus (refer modbus register 46091).

Value for Energy resolution can be set to Wh,kWh or MWh.

Minimum resolution of energy that can be set in energy start count register is, the Energy resolution set by user.

For Eg.: Energy start count can be set to minimum 1Wh if the value on modbus register 46091 is set to Wh Or Energy start count can be set to minimum 1MWh if the value on modbus register 46091 is set to MWh.

Maximum value that can be set in the main energy start count register is $(10^{(EDRC)}-1)$.

Where:

EDRC => Energy digit reset count set by user from display or modbus

For display setting refer Section 3.2.2.9

For modbus refer Register 46093

Example for calculating maximum limit of main energy start count :

If EDRC is 7 then Maximum value that can be set in the main energy start count (M) register is

$$\begin{aligned} &= (10^{(EDRC)}-1) \\ &= ((10^7)-1) \\ &= (10000000-1) \\ &= 9999999 \end{aligned}$$

Similarly if EDRC is 8 the maximum value is 99999999 & if EDRC is 9 maximum value is 999999999.

Maximum value that can be set in the Overflow energy start count register is 99999999 for Wh renergy resolution ,99999 for kWh energy resolution ,99 for MWh resolution.

Note: Energy start Count can only be entered in integer value.

5. Relay Output (Optional) :

The Meter is provided with relay for pulse output, for limit switch, as a Timer, Load health, Tariff as well as RTC Relay.

5.1 Pulse Output :

Pulse Output is the potential free, very fast acting relay contact which can be used to drive an external mechanical counter for energy measurement. The Pulse Output can be configured to any of the energy (refer **TABLE 3**)

TABLE 2 : Energy Pulse Rate Divisor

1.For Energy Output in Whr

Divisor	Pulse rate	
	Pulse	System Power*
	1 per Whr	Up to 3600 W
1	1 per kWhr	Up to 3600 kW
	1 per MWhr	Above 3600 kW up to 30000 kW
	1 per 10Whr	Up to 3600 W
10	1 per 10kWhr	Up to 3600 kW
	1 per 10MWhr	Above 3600 kW up to 30000 kW
100	1 per 100Whr	Up to 3600 W
	1 per 100kWhr	Up to 3600 kW
	1 per 100MWhr	Above 3600 kW up to 30000 kW
1000	1 per 1000Whr	Up to 3600 W
	1 per 1000kWhr	Up to 3600 kW
	1 per 1000MWhr	Above 3600 kW up to 30000 kW
Pulse Duration 60 ms, 100 ms or 200 ms		

2.For Energy Output in kWhr

Divisor	Pulse rate	
	Pulse	System Power*
1	1 per kWhr	Up to 3600 kW
	1 per MWhr	Above 3600 kW

3.For Energy Output in MWhr

Divisor	Pulse rate	
	Pulse	
1	1 per MWhr	

Above options are also applicable for Apparent and Reactive Energy.

*Note:

- 1) System power = $3 \times CT(\text{Primary}) \times PT(\text{Primary})$ L-N for 3 Phase 4 Wire System energy
- 2) System power = $\text{Root}3 \times CT(\text{Primary}) \times PT(\text{Primary})$ L-L for 3 Phase 3 Wire System energy

**TABLE 3 : Pulse / Tariff
Configuration Select**

Code	Configuration
0	None
1	Wh Import Channel 1
2	Wh Import Channel 2
3	Wh Import Channel 3
4	Wh Import Channel 4
5	Wh Import Channel 5
6	Wh Import Channel 6
7	Wh Import Channel 7
8	Wh Import Channel 8
9	Wh Import Channel 9
10	Wh Import Channel 10
11	Wh Import Channel 11
12	Wh Import Channel 12
13	Wh Export Channel 1
14	Wh Export Channel 2
15	Wh Export Channel 3
16	Wh Export Channel 4
17	Wh Export Channel 5
18	Wh Export Channel 6
19	Wh Export Channel 7
20	Wh Export Channel 8
21	Wh Export Channel 9
22	Wh Export Channel 10
23	Wh Export Channel 11
24	Wh Export Channel 12
25	VArh Capacitive Channel 1
26	VArh Capacitive Channel 2
27	VArh Capacitive Channel 3
28	VArh Capacitive Channel 4
29	VArh Capacitive Channel 5

TABLE 3 : Continue...

Code	Configuration
30	VArh Capacitive Channel 6
31	VArh Capacitive Channel 7
32	VArh Capacitive Channel 8
33	VArh Capacitive Channel 9
34	VArh Capacitive Channel 10
35	VArh Capacitive Channel 11
36	VArh Capacitive Channel 12
37	VArh Inductive Channel 1
38	VArh Inductive Channel 2
39	VArh Inductive Channel 3
40	VArh Inductive Channel 4
41	VArh Inductive Channel 5
42	VArh Inductive Channel 6
43	VArh Inductive Channel 7
44	VArh Inductive Channel 8
45	VArh Inductive Channel 9
46	VArh Inductive Channel 10
47	VArh Inductive Channel 11
48	VArh Inductive Channel 12
49	VAh Channel 1
50	VAh Channel 2
51	VAh Channel 3
52	VAh Channel 4
53	VAh Channel 5
54	VAh Channel 6
55	VAh Channel 7
56	VAh Channel 8
57	VAh Channel 9
58	VAh Channel 10
59	VAh Channel 11

TABLE 3 : Continue...

Code	Configuration
60	VAh Channel 12
61	Wh Import System 1
62	Wh Import System 2
63	Wh Import System 3
64	Wh Import System 4
65	Wh Export System 1
66	Wh Export System 2
67	Wh Export System 3
68	Wh Export System 4
69	VARh Capacitive System 1
70	VARh Capacitive System 2
71	VARh Capacitive System 3
72	VARh Capacitive System 4
73	VARh Inductive System 1
74	VARh Inductive System 2
75	VARh Inductive System 3
76	VARh Inductive System 4
77	VAh System 1
78	VAh System 2
79	VAh System 3
80	VAh System 4

**Note 1 : System 1 parameter represents Three Phase system present at channel 1,2, and 3.
Similarly System 2 parameter represents Three Phase system present at channel 4,5,6
and so on.**

**Note 2 : If a channel is not a part of Three Phase system, then the corresponding system
parameter will show value 0.**

5.2 Limit Switch :

Limit switch can be used to monitor the measured parameter (Ref. **TABLE 4**) in relation with to a set limit. The limit switch can be configured in one of the four mode given below:-

- 1) Hi alarm & Energized Relay
- 2) Hi alarm & De-Energized Relay
- 3) Lo alarm & Energized Relay
- 4) Lo alarm & De-Energized Relay

With User selectable Trip point, Hysteresis, Energizing Delay & De-Energizing delay.

Hi Alarm:

If Hi-Alarm Energized or Hi Alarm De-Energized option is selected then relay will get energized or De-energized, if selected parameter is greater than or equal to trip point.

Lo Alarm:

If Lo-Alarm Energized or Lo Alarm De-Energized option is selected then relay will get energized or De-energized, if selected parameter is less than or equal to trip point.

Note: For Lo-Alarm configuration, set the values of trip point & hysteresis such that % trip point + % hysteresis should be less than 100% Value.

Example for Phase angle:

If trip point is set 70% then maximum applicable hysteresis is 42.8%. i.e Trip point 70% (252°) + Hysteresis 42.8% (107.8°) = 359.8° If total value is greater than the 100% i.e. 360° then relay will not release.

Example for PF:

For Hi-Alarm Energized, if trip point is 70% & hysteresis is 30%, then trip value = $0.7 \times 90^\circ = 63^\circ$. Tripping PF = $\cos(63^\circ) = 0.4539$ & hysteresis = $0.3 \times 0.4539 = 0.136$.

Hence, the relay will energize above 0.4539 and de-energize below 0.3179.

Note: This function will work irrespective of +/- sign. It depends only on value.

Trip point:

Trip point can be set in the range as specified in **TABLE 4** of nominal value for Hi-Alarm & 10% to 100% of nominal value for Lo-Alarm.

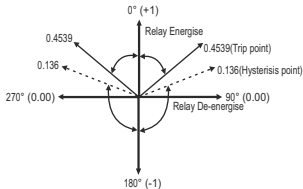

Hysteresis:

Hysteresis can be set in the range of 0.5% to 50 % of set trip point. If Hi-alarm Energized or Hi-alarm De-energized is selected then relay will get De-energized or Energized respectively, if set parameter value is less than Hysteresis. Similarly if Lo-alarm Energized or Lo-alarm De-Energized.

Note : In case of lo alarm if trip point is set greater than 80% then the maximum hysteresis can be set such that the total Trip point+ Hysteresis(% of trip point value) will not exceed 120% of range.

For example :If trip point is set at 90%, then maximum 33.3% hysteresis should be set such that, $[90 + 29.99 (33.3\% \text{ of } 90)] = 120$.

Energizing Delay:

The energizing delay can be set in the range from 1 to 9999 seconds.

De-Energizing Delay:

The De-energizing delay can be set in the range from 1 to 9999 seconds.

Examples of different configurations

Parameter No. 4 (Current1)

Trip Point = 50%

Hysteresis = 50% of trip point

Energising Delay: 2 sec

De-energising Delay: 2 sec

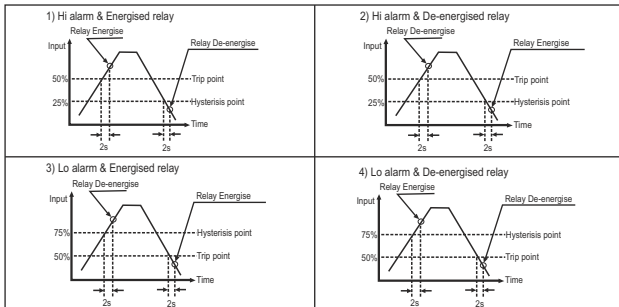

TABLE 4 : Parameters for Limit output

Parameter No.	Parameter	3P 4W	3P 3W	1P 2W	Trip Point Set Range	100% Value
0	None	✓	✓	✓	-	-
1	Voltage L1	✓	✓	✓	10 - 120 %	Vnom (L-N)
2	Voltage L2	✓	✓	✓	10 - 120 %	Vnom (L-N)
3	Voltage L3	✓	✓	✓	10 - 120 %	Vnom (L-N)
4	Voltage L12	✓	✓	✓	10 - 120 %	Vnom (L-L)
5	Voltage L23	✓	✓	✓	10 - 120 %	Vnom (L-L)
6	Voltage L31	✓	✓	✓	10 - 120 %	Vnom (L-L)
7	Current Channel 1	✓	✓	✓	10 - 120 %	Inom
8	Current Channel 2	✓	✓	✓	10 - 120 %	Inom
9	Current Channel 3	✓	✓	✓	10 - 120 %	Inom
10	Current Channel 4	✓	✓	✓	10 - 120 %	Inom
11	Current Channel 5	✓	✓	✓	10 - 120 %	Inom
12	Current Channel 6	✓	✓	✓	10 - 120 %	Inom
13	Current Channel 7	✓	✓	✓	10 - 120 %	Inom
14	Current Channel 8	✓	✓	✓	10 - 120 %	Inom
15	Current Channel 9	✓	✓	✓	10 - 120 %	Inom
16	Current Channel 10	✓	✓	✓	10 - 120 %	Inom
17	Current Channel 11	✓	✓	✓	10 - 120 %	Inom
18	Current Channel 12	✓	✓	✓	10 - 120 %	Inom
19	W Channel 1	✓	✗	✓	10 - 120 %	Nom ⁽¹⁾
20	W Channel 2	✓	✗	✓	10 - 120 %	Nom ⁽¹⁾
21	W Channel 3	✓	✗	✓	10 - 120 %	Nom ⁽¹⁾
22	W Channel 4	✓	✗	✓	10 - 120 %	Nom ⁽¹⁾
23	W Channel 5	✓	✗	✓	10 - 120 %	Nom ⁽¹⁾
24	W Channel 6	✓	✗	✓	10 - 120 %	Nom ⁽¹⁾
25	W Channel 7	✓	✗	✓	10 - 120 %	Nom ⁽¹⁾
26	W Channel 8	✓	✗	✓	10 - 120 %	Nom ⁽¹⁾
27	W Channel 9	✓	✗	✓	10 - 120 %	Nom ⁽¹⁾
28	W Channel 10	✓	✗	✓	10 - 120 %	Nom ⁽¹⁾
29	W Channel 11	✓	✗	✓	10 - 120 %	Nom ⁽¹⁾
30	W Channel 12	✓	✗	✓	10 - 120 %	Nom ⁽¹⁾

TABLE 4 : Continue...

Parameter No.	Parameter	3P 4W	3P 3W	1P 2W	Trip Point Set Range	100% Value
31	VA Channel 1	✓	✗	✓	10 - 120 % -	Nom ⁽¹⁾
32	VA Channel 2	✓	✗	✓	10 - 120 %	Nom ⁽¹⁾
33	VA Channel 3	✓	✗	✓	10 - 120 %	Nom ⁽¹⁾
34	VA Channel 4	✓	✗	✓	10 - 120 %	Nom ⁽¹⁾
35	VA Channel 5	✓	✗	✓	10 - 120 %	Nom ⁽¹⁾
36	VA Channel 6	✓	✗	✓	10 - 120 %	Nom ⁽¹⁾
37	VA Channel 7	✓	✗	✓	10 - 120 %	Nom ⁽¹⁾
38	VA Channel 8	✓	✗	✓	10 - 120 %	Nom ⁽¹⁾
39	VA Channel 9	✓	✗	✓	10 - 120 %	Nom ⁽¹⁾
40	VA Channel 10	✓	✗	✓	10 - 120 %	Nom ⁽¹⁾
41	VA Channel 11	✓	✗	✓	10 - 120 %	Nom ⁽¹⁾
42	VA Channel 12	✓	✗	✓	10 - 120 %	Nom ⁽¹⁾
43	VAr Channel 1	✓	✗	✓	10 - 120 %	Nom ⁽¹⁾
44	VAr Channel 2	✓	✗	✓	10 - 120 %	Nom ⁽¹⁾
45	VAr Channel 3	✓	✗	✓	10 - 120 %	Nom ⁽¹⁾
46	VAr Channel 4	✓	✗	✓	10 - 120 %	Nom ⁽¹⁾
47	VAr Channel 5	✓	✗	✓	10 - 120 %	Nom ⁽¹⁾
48	VAr Channel 6	✓	✗	✓	10 - 120 %	Nom ⁽¹⁾
49	VAr Channel 7	✓	✗	✓	10 - 120 %	Nom ⁽¹⁾
50	VAr Channel 8	✓	✗	✓	10 - 120 %	Nom ⁽¹⁾
51	VAr Channel 9	✓	✗	✓	10 - 120 %	Nom ⁽¹⁾
52	VAr Channel 10	✓	✗	✓	10 - 120 %	Nom ⁽¹⁾
53	VAr Channel 11	✓	✗	✓	10 - 120 %	Nom ⁽¹⁾
54	VAr Channel 12	✓	✗	✓	10 - 120 %	Nom ⁽¹⁾
55	Power Factor Channel 1	✓	✗	✓	10 - 90 %	90°
56	Power Factor Channel 2	✓	✗	✓	10 - 90 %	90°
57	Power Factor Channel 3	✓	✗	✓	10 - 90 %	90°
58	Power Factor Channel 4	✓	✗	✓	10 - 90 %	90°
59	Power Factor Channel 5	✓	✗	✓	10 - 90 %	90°
60	Power Factor Channel 6	✓	✗	✓	10 - 90 %	90°
61	Power Factor Channel 7	✓	✗	✓	10 - 90 %	90°

TABLE 4 : Continue...

Parameter No.	Parameter	3P 4W	3P 3W	1P 2W	Trip Point Set Range	100% Value
62	Power Factor Channel 8	✓	✗	✓	10 - 90 %	90°
63	Power Factor Channel 9	✓	✗	✓	10 - 90 %	90°
64	Power Factor Channel 10	✓	✗	✓	10 - 90 %	90°
65	Power Factor Channel 11	✓	✗	✓	10 - 90 %	90°
66	Power Factor Channel 12	✓	✗	✓	10 - 90 %	90°
67	Phase Angle Channel 1	✓	✗	✓	10 - 90 %	360°
68	Phase Angle Channel 2	✓	✗	✓	10 - 90 %	360°
69	Phase Angle Channel 3	✓	✗	✓	10 - 90 %	360°
70	Phase Angle Channel 4	✓	✗	✓	10 - 90 %	360°
71	Phase Angle Channel 5	✓	✗	✓	10 - 90 %	360°
72	Phase Angle Channel 6	✓	✗	✓	10 - 90 %	360°
73	Phase Angle Channel 7	✓	✗	✓	10 - 90 %	360°
74	Phase Angle Channel 8	✓	✗	✓	10 - 90 %	360°
75	Phase Angle Channel 9	✓	✗	✓	10 - 90 %	360°
76	Phase Angle Channel 10	✓	✗	✓	10 - 90 %	360°
77	Phase Angle Channel 11	✓	✗	✓	10 - 90 %	360°
78	Phase Angle Channel 12	✓	✗	✓	10 - 90 %	360°
79	Wh Import Channel 1	✓	✗	✓	10-9999999	-
80	Wh Import Channel 2	✓	✗	✓	10-9999999	-
81	Wh Import Channel 3	✓	✗	✓	10-9999999	-
82	Wh Import Channel 4	✓	✗	✓	10-9999999	-
83	Wh Import Channel 5	✓	✗	✓	10-9999999	-
84	Wh Import Channel 6	✓	✗	✓	10-9999999	-
85	Wh Import Channel 7	✓	✗	✓	10-9999999	-
86	Wh Import Channel 8	✓	✗	✓	10-9999999	-
87	Wh Import Channel 9	✓	✗	✓	10-9999999	-
88	Wh Import Channel 10	✓	✗	✓	10-9999999	-
89	Wh Import Channel 11	✓	✗	✓	10-9999999	-
90	Wh Import Channel 12	✓	✗	✓	10-9999999	-
91	Wh Export Channel 1	✓	✗	✓	10-9999999	-
92	Wh Export Channel 2	✓	✗	✓	10-9999999	-

TABLE 4 : Continue...

Parameter No.	Parameter	3P 4W	3P 3W	1P 2W	Trip Point Set Range	100% Value
93	Wh Export Channel 3	✓	✗	✓	10-9999999	-
94	Wh Export Channel 4	✓	✗	✓	10-9999999	-
95	Wh Export Channel 5	✓	✗	✓	10-9999999	-
96	Wh Export Channel 6	✓	✗	✓	10-9999999	-
97	Wh Export Channel 7	✓	✗	✓	10-9999999	-
98	Wh Export Channel 8	✓	✗	✓	10-9999999	-
99	Wh Export Channel 9	✓	✗	✓	10-9999999	-
100	Wh Export Channel 10	✓	✗	✓	10-9999999	-
101	Wh Export Channel 11	✓	✗	✓	10-9999999	-
102	Wh Export Channel 12	✓	✗	✓	10-9999999	-
103	VARh Capacitive Channel 1	✓	✗	✓	10-9999999	-
104	VARh Capacitive Channel 2	✓	✗	✓	10-9999999	-
105	VARh Capacitive Channel 3	✓	✗	✓	10-9999999	-
106	VARh Capacitive Channel 4	✓	✗	✓	10-9999999	-
107	VARh Capacitive Channel 5	✓	✗	✓	10-9999999	-
108	VARh Capacitive Channel 6	✓	✗	✓	10-9999999	-
109	VARh Capacitive Channel 7	✓	✗	✓	10-9999999	-
110	VARh Capacitive Channel 8	✓	✗	✓	10-9999999	-
111	VARh Capacitive Channel 9	✓	✗	✓	10-9999999	-
112	VARh Capacitive Channel 10	✓	✗	✓	10-9999999	-
113	VARh Capacitive Channel 11	✓	✗	✓	10-9999999	-
114	VARh Capacitive Channel 12	✓	✗	✓	10-9999999	-
115	VARh Inductive Channel 1	✓	✗	✓	10-9999999	-
116	VARh Inductive Channel 2	✓	✗	✓	10-9999999	-
117	VARh Inductive Channel 3	✓	✗	✓	10-9999999	-
118	VARh Inductive Channel 4	✓	✗	✓	10-9999999	-
119	VARh Inductive Channel 5	✓	✗	✓	10-9999999	-
120	VARh Inductive Channel 6	✓	✗	✓	10-9999999	-
121	VARh Inductive Channel 7	✓	✗	✓	10-9999999	-
122	VARh Inductive Channel 8	✓	✗	✓	10-9999999	-
123	VARh Inductive Channel 9	✓	✗	✓	10-9999999	-

TABLE 4 : Continue...

Parameter No.	Parameter	3P 4W	3P 3W	1P 2W	Trip Point Set Range	100% Value
124	VArh Inductive Channel 10	✓	✗	✓	10-9999999	-
125	VArh Inductive Channel 11	✓	✗	✓	10-9999999	-
126	VArh Inductive Channel 12	✓	✗	✓	10-9999999	-
127	VAh Channel 1	✓	✗	✓	10-9999999	-
128	VAh Channel 2	✓	✗	✓	10-9999999	-
129	VAh Channel 3	✓	✗	✓	10-9999999	-
130	VAh Channel 4	✓	✗	✓	10-9999999	-
131	VAh Channel 5	✓	✗	✓	10-9999999	-
132	VAh Channel 6	✓	✗	✓	10-9999999	-
133	VAh Channel 7	✓	✗	✓	10-9999999	-
134	VAh Channel 8	✓	✗	✓	10-9999999	-
135	VAh Channel 9	✓	✗	✓	10-9999999	-
136	VAh Channel 10	✓	✗	✓	10-9999999	-
137	VAh Channel 11	✓	✗	✓	10-9999999	-
138	VAh Channel 12	✓	✗	✓	10-9999999	-
199	kW Import demand Channel 1	✓	✗	✓	10-120%	Nom ⁽¹⁾
200	kW Import demand Channel 2	✓	✗	✓	10-120%	Nom ⁽¹⁾
201	kW Import demand Channel 3	✓	✗	✓	10-120%	Nom ⁽¹⁾
202	kW Import demand Channel 4	✓	✗	✓	10-120%	Nom ⁽¹⁾
203	kW Import demand Channel 5	✓	✗	✓	10-120%	Nom ⁽¹⁾
204	kW Import demand Channel 6	✓	✗	✓	10-120%	Nom ⁽¹⁾
205	kW Import demand Channel 7	✓	✗	✓	10-120%	Nom ⁽¹⁾
206	kW Import demand Channel 8	✓	✗	✓	10-120%	Nom ⁽¹⁾
207	kW Import demand Channel 9	✓	✗	✓	10-120%	Nom ⁽¹⁾
208	kW Import demand Channel 10	✓	✗	✓	10-120%	Nom ⁽¹⁾
209	kW Import demand Channel 11	✓	✗	✓	10-120%	Nom ⁽¹⁾
210	kW Import demand Channel 12	✓	✗	✓	10-120%	Nom ⁽¹⁾
211	kW Export demand Channel 1	✓	✗	✓	10-120%	Nom ⁽¹⁾
212	kW Export demand Channel 2	✓	✗	✓	10-120%	Nom ⁽¹⁾
213	kW Export demand Channel 3	✓	✗	✓	10-120%	Nom ⁽¹⁾
214	kW Export demand Channel 4	✓	✗	✓	10-120%	Nom ⁽¹⁾

TABLE 4 : Continue...

Parameter No.	Parameter	3P 4W	3P 3W	1P 2W	Trip Point Set Range	100% Value
215	kW Export demand Channel 5	✓	✗	✓	10-9999999	Nom ⁽¹⁾
216	kW Export demand Channel 6	✓	✗	✓	10-9999999	Nom ⁽¹⁾
217	kW Export demand Channel 7	✓	✗	✓	10-9999999	Nom ⁽¹⁾
218	kW Export demand Channel 8	✓	✗	✓	10-9999999	Nom ⁽¹⁾
219	kW Export demand Channel 9	✓	✗	✓	10-9999999	Nom ⁽¹⁾
220	kW Export demand Channel 10	✓	✗	✓	10-9999999	Nom ⁽¹⁾
221	kW Export demand Channel 11	✓	✗	✓	10-9999999	Nom ⁽¹⁾
222	kW Export demand Channel 12	✓	✗	✓	10-9999999	Nom ⁽¹⁾
223	kVAr Capacitive demand Channel 1	✓	✗	✓	10-9999999	Nom ⁽¹⁾
224	kVAr Capacitive demand Channel 2	✓	✗	✓	10-9999999	Nom ⁽¹⁾
225	kVAr Capacitive demand Channel 3	✓	✗	✓	10-9999999	Nom ⁽¹⁾
226	kVAr Capacitive demand Channel 4	✓	✗	✓	10-9999999	Nom ⁽¹⁾
227	kVAr Capacitive demand Channel 5	✓	✗	✓	10-9999999	Nom ⁽¹⁾
228	kVAr Capacitive demand Channel 6	✓	✗	✓	10-9999999	Nom ⁽¹⁾
229	kVAr Capacitive demand Channel 7	✓	✗	✓	10-9999999	Nom ⁽¹⁾
230	kVAr Capacitive demand Channel 8	✓	✗	✓	10-120%	Nom ⁽¹⁾
231	kVAr Capacitive demand Channel 9	✓	✗	✓	10-120%	Nom ⁽¹⁾
232	kVAr Capacitive demand Channel 10	✓	✗	✓	10-120%	Nom ⁽¹⁾
233	kVAr Capacitive demand Channel 11	✓	✗	✓	10-120%	Nom ⁽¹⁾
234	kVAr Capacitive demand Channel 12	✓	✗	✓	10-120%	Nom ⁽¹⁾
235	kVAr Inductive demand Channel 1	✓	✗	✓	10-120%	Nom ⁽¹⁾
236	kVAr Inductive demand Channel 2	✓	✗	✓	10-120%	Nom ⁽¹⁾
237	kVAr Inductive demand Channel 3	✓	✗	✓	10-120%	Nom ⁽¹⁾
238	kVAr Inductive demand Channel 4	✓	✗	✓	10-120%	Nom ⁽¹⁾
239	kVAr Inductive demand Channel 5	✓	✗	✓	10-120%	Nom ⁽¹⁾
240	kVAr Inductive demand Channel 6	✓	✗	✓	10-120%	Nom ⁽¹⁾
241	kVAr Inductive demand Channel 7	✓	✗	✓	10-120%	Nom ⁽¹⁾
242	kVAr Inductive demand Channel 8	✓	✗	✓	10-120%	Nom ⁽¹⁾
243	kVAr Inductive demand Channel 9	✓	✗	✓	10-120%	Nom ⁽¹⁾
244	kVAr Inductive demand Channel 10	✓	✗	✓	10-120%	Nom ⁽¹⁾
245	kVAr Inductive demand Channel 11	✓	✗	✓	10-120%	Nom ⁽¹⁾

TABLE 4 : Continue...

Parameter No.	Parameter	3P 4W	3P 3W	1P 2W	Trip Point Set Range	100% Value
246	kVA Inductive demand Channel 12	✓	✗	✓	10-120%	Nom ⁽¹⁾
247	kVA demand Channel 1	✓	✗	✓	10-120%	Nom ⁽¹⁾
248	kVA demand Channel 2	✓	✗	✓	10-120%	Nom ⁽¹⁾
249	kVA demand Channel 3	✓	✗	✓	10-120%	Nom ⁽¹⁾
250	kVA demand Channel 4	✓	✗	✓	10-120%	Nom ⁽¹⁾
251	kVA demand Channel 5	✓	✗	✓	10-120%	Nom ⁽¹⁾
252	kVA demand Channel 6	✓	✗	✓	10-120%	Nom ⁽¹⁾
253	kVA demand Channel 7	✓	✗	✓	10-120%	Nom ⁽¹⁾
254	kVA demand Channel 8	✓	✗	✓	10-120%	Nom ⁽¹⁾
255	kVA demand Channel 9	✓	✗	✓	10-120%	Nom ⁽¹⁾
256	kVA demand Channel 10	✓	✗	✓	10-120%	Nom ⁽¹⁾
257	kVA demand Channel 11	✓	✗	✓	10-120%	Nom ⁽¹⁾
258	kVA demand Channel 12	✓	✗	✓	10-120%	Nom ⁽¹⁾
259	Current demand Channel 1	✓	✗	✓	10-120%	Inom
260	Current demand Channel 2	✓	✗	✓	10-120%	Inom
261	Current demand Channel 3	✓	✗	✓	10-120%	Inom
262	Current demand Channel 4	✓	✗	✓	10-120%	Inom
263	Current demand Channel 5	✓	✗	✓	10-120%	Inom
264	Current demand Channel 6	✓	✗	✓	10-120%	Inom
265	Current demand Channel 7	✓	✗	✓	10-120%	Inom
266	Current demand Channel 8	✓	✗	✓	10-120%	Inom
267	Current demand Channel 9	✓	✗	✓	10-120%	Inom
268	Current demand Channel 10	✓	✗	✓	10-120%	Inom
269	Current demand Channel 11	✓	✗	✓	10-120%	Inom
270	Current demand Channel 12	✓	✗	✓	10-120%	Inom
271	kW Import Max demand Channel 1	✓	✗	✓	10-120%	Nom ⁽¹⁾
272	kW Import Max demand Channel 2	✓	✗	✓	10-120%	Nom ⁽¹⁾
273	kW Import Max demand Channel 3	✓	✗	✓	10-120%	Nom ⁽¹⁾
274	kW Import Max demand Channel 4	✓	✗	✓	10-120%	Nom ⁽¹⁾
275	kW Import Max demand Channel 5	✓	✗	✓	10-120%	Nom ⁽¹⁾
276	kW Import Max demand Channel 6	✓	✗	✓	10-120%	Nom ⁽¹⁾

TABLE 4 : Continue...

Parameter No.	Parameter	3P 4W	3P 3W	1P 2W	Trip Point Set Range	100% Value
277	kW Import Max demand Channel 7	✓	✗	✓	10-120%	Nom ⁽¹⁾
278	kW Import Max demand Channel 8	✓	✗	✓	10-120%	Nom ⁽¹⁾
279	kW Import Max demand Channel 9	✓	✗	✓	10-120%	Nom ⁽¹⁾
280	kW Import Max demand Channel 10	✓	✗	✓	10-120%	Nom ⁽¹⁾
281	kW Import Max demand Channel 11	✓	✗	✓	10-120%	Nom ⁽¹⁾
282	kW Import Max demand Channel 12	✓	✗	✓	10-120%	Nom ⁽¹⁾
283	kW Export Max demand Channel 1	✓	✗	✓	10-120%	Nom ⁽¹⁾
284	kW Export Max demand Channel 2	✓	✗	✓	10-120%	Nom ⁽¹⁾
285	kW Export Max demand Channel 3	✓	✗	✓	10-120%	Nom ⁽¹⁾
286	kW Export Max demand Channel 4	✓	✗	✓	10-120%	Nom ⁽¹⁾
287	kW Export Max demand Channel 5	✓	✗	✓	10-120%	Nom ⁽¹⁾
288	kW Export Max demand Channel 6	✓	✗	✓	10-120%	Nom ⁽¹⁾
289	kW Export Max demand Channel 7	✓	✗	✓	10-120%	Nom ⁽¹⁾
290	kW Export Max demand Channel 8	✓	✗	✓	10-120%	Nom ⁽¹⁾
291	kW Export Max demand Channel 9	✓	✗	✓	10-120%	Nom ⁽¹⁾
292	kW Export Max demand Channel 10	✓	✗	✓	10-120%	Nom ⁽¹⁾
293	kW Export Max demand Channel 11	✓	✗	✓	10-120%	Nom ⁽¹⁾
294	kW Export Max demand Channel 12	✓	✗	✓	10-120%	Nom ⁽¹⁾
295	kVAr Capacitive Max demand Channel 1	✓	✗	✓	10-120%	Nom ⁽¹⁾
296	kVAr Capacitive Max demand Channel 2	✓	✗	✓	10-120%	Nom ⁽¹⁾
297	kVAr Capacitive Max demand Channel 3	✓	✗	✓	10-120%	Nom ⁽¹⁾
298	kVAr Capacitive Max demand Channel 4	✓	✗	✓	10-120%	Nom ⁽¹⁾
299	kVAr Capacitive Max demand Channel 5	✓	✗	✓	10-120%	Nom ⁽¹⁾
300	kVAr Capacitive Max demand Channel 6	✓	✗	✓	10-120%	Nom ⁽¹⁾
301	kVAr Capacitive Max demand Channel 7	✓	✗	✓	10-120%	Nom ⁽¹⁾
302	kVAr Capacitive Max demand Channel 8	✓	✗	✓	10-120%	Nom ⁽¹⁾
303	kVAr Capacitive Max demand Channel 9	✓	✗	✓	10-120%	Nom ⁽¹⁾
304	kVAr Capacitive Max demand Channel 10	✓	✗	✓	10-120%	Nom ⁽¹⁾
305	kVAr Capacitive Max demand Channel 11	✓	✗	✓	10-120%	Nom ⁽¹⁾
306	kVAr Capacitive Max demand Channel 12	✓	✗	✓	10-120%	Nom ⁽¹⁾
307	kVAr Inductive Max demand Channel 1	✓	✗	✓	10-120%	Nom ⁽¹⁾

TABLE 4 : Continue...

Parameter No.	Parameter	3P 4W	3P 3W	1P 2W	Trip Point Set Range	100% Value
308	kVAr Inductive Max demand Channel 2	✓	✗	✓	10-120%	Nom ⁽¹⁾
309	kVAr Inductive Max demand Channel 3	✓	✗	✓	10-120%	Nom ⁽¹⁾
310	kVAr Inductive Max demand Channel 4	✓	✗	✓	10-120%	Nom ⁽¹⁾
311	kVAr Inductive Max demand Channel 5	✓	✗	✓	10-120%	Nom ⁽¹⁾
312	kVAr Inductive Max demand Channel 6	✓	✗	✓	10-120%	Nom ⁽¹⁾
313	kVAr Inductive Max demand Channel 7	✓	✗	✓	10-120%	Nom ⁽¹⁾
314	kVAr Inductive Max demand Channel 8	✓	✗	✓	10-120%	Nom ⁽¹⁾
315	kVAr Inductive Max demand Channel 9	✓	✗	✓	10-120%	Nom ⁽¹⁾
316	kVAr Inductive Max demand Channel 10	✓	✗	✓	10-120%	Nom ⁽¹⁾
317	kVAr Inductive Max demand Channel 11	✓	✗	✓	10-120%	Nom ⁽¹⁾
318	kVAr Inductive Max demand Channel 12	✓	✗	✓	10-120%	Nom ⁽¹⁾
319	kVA Max demand Channel 1	✓	✗	✓	10-120%	Nom ⁽¹⁾
320	kVA Max demand Channel 2	✓	✗	✓	10-120%	Nom ⁽¹⁾
321	kVA Max demand Channel 3	✓	✗	✓	10-120%	Nom ⁽¹⁾
322	kVA Max demand Channel 4	✓	✗	✓	10-120%	Nom ⁽¹⁾
323	kVA Max demand Channel 5	✓	✗	✓	10-120%	Nom ⁽¹⁾
324	kVA Max demand Channel 6	✓	✗	✓	10-120%	Nom ⁽¹⁾
325	kVA Max demand Channel 7	✓	✗	✓	10-120%	Nom ⁽¹⁾
326	kVA Max demand Channel 8	✓	✗	✓	10-120%	Nom ⁽¹⁾
327	kVA Max demand Channel 9	✓	✗	✓	10-120%	Nom ⁽¹⁾
328	kVA Max demand Channel 10	✓	✗	✓	10-120%	Nom ⁽¹⁾
329	kVA Max demand Channel 11	✓	✗	✓	10-120%	Nom ⁽¹⁾
330	kVA Max demand Channel 12	✓	✗	✓	10-120%	Nom ⁽¹⁾
331	Current Max demand Channel 1	✓	✗	✓	10-120%	Inom
332	Current Max demand Channel 2	✓	✗	✓	10-120%	Inom
333	Current Max demand Channel 3	✓	✗	✓	10-120%	Inom
334	Current Max demand Channel 4	✓	✗	✓	10-120%	Inom
335	Current Max demand Channel 5	✓	✗	✓	10-120%	Inom
336	Current Max demand Channel 6	✓	✗	✓	10-120%	Inom
337	Current Max demand Channel 7	✓	✗	✓	10-120%	Inom
338	Current Max demand Channel 8	✓	✗	✓	10-120%	Inom

TABLE 4 : Continue...

Parameter No.	Parameter	3P 4W	3P 3W	1P 2W	Trip Point Set Range	100% Value
339	Current Max demand Channel 9	✓	✗	✓	10-120%	Inom
340	Current Max demand Channel 10	✓	✗	✓	10-120%	Inom
341	Current Max demand Channel 11	✓	✗	✓	10-120%	Inom
342	Current Max demand Channel 12	✓	✗	✓	10-120%	Inom
529	System Voltage LN Avg	✓	✓	✓	10-120%	Vnom(L-N)
531	System Voltage LL Avg	✓	✓	✓	10-120%	Vnom(L-L)
533	Current Avg System 1	✓	✓	✗	10-120%	Inom
534	Current Avg System 2	✓	✓	✗	10-120%	Inom
535	Current Avg System 3	✓	✓	✗	10-120%	Inom
536	Current Avg System 4	✓	✓	✗	10-120%	Inom
545	Watt Sum System 1	✓	✓	✗	10-120%	Nom ⁽¹⁾
546	Watt Sum System 2	✓	✓	✗	10-120%	Nom ⁽¹⁾
547	Watt Sum System 3	✓	✓	✗	10-120%	Nom ⁽¹⁾
548	Watt Sum System 4	✓	✓	✗	10-120%	Nom ⁽¹⁾
553	VA Sum System 1	✓	✓	✗	10-120%	Nom ⁽¹⁾
554	VA Sum System 2	✓	✓	✗	10-120%	Nom ⁽¹⁾
555	VA Sum System 3	✓	✓	✗	10-120%	Nom ⁽¹⁾
556	VA Sum System 4	✓	✓	✗	10-120%	Nom ⁽¹⁾
561	VAr Sum System 1	✓	✓	✗	10-120%	Nom ⁽¹⁾
562	VAr Sum System 2	✓	✓	✗	10-120%	Nom ⁽¹⁾
563	VAr Sum System 3	✓	✓	✗	10-120%	Nom ⁽¹⁾
564	VAr Sum System 4	✓	✓	✗	10-120%	Nom ⁽¹⁾
565	Power Factor Avg System 1	✓	✓	✗	10-90%	90
566	Power Factor Avg System 2	✓	✓	✗	10-90%	90°
567	Power Factor Avg System 3	✓	✓	✗	10-90%	90°
568	Power Factor Avg System 4	✓	✓	✗	10-90%	90°
573	Phase Angle Avg System 1	✓	✓	✗	10-90%	360°
574	Phase Angle Avg System 2	✓	✓	✗	10-90%	360°
575	Phase Angle Avg System 3	✓	✓	✗	10-90%	360°
576	Phase Angle Avg System 4	✓	✓	✗	10-90%	360°
581	Wh Import System 1	✓	✓	✗	10-9999999	-

TABLE 4 : Continue...

Parameter No.	Parameter	3P 4W	3P 3W	1P 2W	Trip Point Set Range	100% Value
582	Wh Import System 2	✓	✓	✗	10-9999999	-
583	Wh Import System 3	✓	✓	✗	10-9999999	-
584	Wh Import System 4	✓	✓	✗	10-9999999	-
585	Wh Export System 1	✓	✓	✗	10-9999999	-
586	Wh Export System 2	✓	✓	✗	10-9999999	-
587	Wh Export System 3	✓	✓	✗	10-9999999	-
588	Wh Export System 4	✓	✓	✗	10-9999999	-
589	VArh Capacitive System 1	✓	✓	✗	10-9999999	-
590	VArh Capacitive System 2	✓	✓	✗	10-9999999	-
591	VArh Capacitive System 3	✓	✓	✗	10-9999999	-
592	VArh Capacitive System 4	✓	✓	✗	10-9999999	-
593	VArh Inductive System 1	✓	✓	✗	10-9999999	-
594	VArh Inductive System 2	✓	✓	✗	10-9999999	-
595	VArh Inductive System 3	✓	✓	✗	10-9999999	-
596	VArh Inductive System 4	✓	✓	✗	10-9999999	-
597	VAh System 1	✓	✓	✗	10-9999999	-
598	VAh System 2	✓	✓	✗	10-9999999	-
599	VAh System 3	✓	✓	✗	10-9999999	-
600	VAh System 4	✓	✓	✗	10-9999999	-
621	kW Import demand System 1	✓	✓	✗	10-120%	Nom ⁽¹⁾
622	kW Import demand System 2	✓	✓	✗	10-120%	Nom ⁽¹⁾
623	kW Import demand System 3	✓	✓	✗	10-120%	Nom ⁽¹⁾
624	kW Import demand System 4	✓	✓	✗	10-120%	Nom ⁽¹⁾
625	kW Export demand System 1	✓	✓	✗	10-120%	Nom ⁽¹⁾
626	kW Export demand System 2	✓	✓	✗	10-120%	Nom ⁽¹⁾
627	kW Export demand System 3	✓	✓	✗	10-120%	Nom ⁽¹⁾
628	kW Export demand System 4	✓	✓	✗	10-120%	Nom ⁽¹⁾
629	kVAh Capacitive demand System 1	✓	✓	✗	10-120%	Nom ⁽¹⁾
630	kVAh Capacitive demand System 2	✓	✓	✗	10-120%	Nom ⁽¹⁾
631	kVAh Capacitive demand System 3	✓	✓	✗	10-120%	Nom ⁽¹⁾
632	kVAh Capacitive demand System 4	✓	✓	✗	10-120%	Nom ⁽¹⁾

TABLE 4 : Continue...

Parameter No.	Parameter	3P 4W	3P 3W	1P 2W	Trip Point Set Range	100% Value
633	kVAr Inductive demand System 1	✓	✓	✗	10-120%	Nom ⁽¹⁾
634	kVAr Inductive demand System 2	✓	✓	✗	10-120%	Nom ⁽¹⁾
635	kVAr Inductive demand System 3	✓	✓	✗	10-120%	Nom ⁽¹⁾
636	kVAr Inductive demand System 4	✓	✓	✗	10-120%	Nom ⁽¹⁾
637	KVA demand System 1	✓	✓	✗	10-120%	Nom ⁽¹⁾
638	KVA demand System 2	✓	✓	✗	10-120%	Nom ⁽¹⁾
639	KVA demand System 3	✓	✓	✗	10-120%	Nom ⁽¹⁾
640	KVA demand System 4	✓	✓	✗	10-120%	Nom ⁽¹⁾
641	Current demand System 1	✓	✓	✗	10-120%	Inom
642	Current demand System 2	✓	✓	✗	10-120%	Inom
643	Current demand System 3	✓	✓	✗	10-120%	Inom
644	Current demand System 4	✓	✓	✗	10-120%	Inom
645	kW Import Max demand System 1	✓	✓	✗	10-120%	Nom ⁽¹⁾
646	kW Import Max demand System 2	✓	✓	✗	10-120%	Nom ⁽¹⁾
647	kW Import Max demand System 3	✓	✓	✗	10-120%	Nom ⁽¹⁾
648	kW Import Max demand System 4	✓	✓	✗	10-120%	Nom ⁽¹⁾
649	KW Export Max demand System 1	✓	✓	✗	10-120%	Nom ⁽¹⁾
650	KW Export Max demand System 2	✓	✓	✗	10-120%	Nom ⁽¹⁾
651	KW Export Max demand System 3	✓	✓	✗	10-120%	Nom ⁽¹⁾
652	KW Export Max demand System 4	✓	✓	✗	10-120%	Nom ⁽¹⁾
653	kVAr Capacitive Max demand System 1	✓	✓	✗	10-120%	Nom ⁽¹⁾
654	kVAr Capacitive Max demand System 2	✓	✓	✗	10-120%	Nom ⁽¹⁾
655	kVAr Capacitive Max demand System 3	✓	✓	✗	10-120%	Nom ⁽¹⁾
656	kVAr Capacitive Max demand System 4	✓	✓	✗	10-120%	Nom ⁽¹⁾
657	kVAr Inductive Max demand System 1	✓	✓	✗	10-120%	Nom ⁽¹⁾
658	kVAr Inductive Max demand System 2	✓	✓	✗	10-120%	Nom ⁽¹⁾
659	kVAr Inductive Max demand System 3	✓	✓	✗	10-120%	Nom ⁽¹⁾
660	kVAr Inductive Max demand System 4	✓	✓	✗	10-120%	Nom ⁽¹⁾
661	kVA Max demand System 1	✓	✓	✗	10-120%	Nom ⁽¹⁾
662	kVA Max demand System 2	✓	✓	✗	10-120%	Nom ⁽¹⁾
663	kVA Max demand System 3	✓	✓	✗	10-120%	Nom ⁽¹⁾

TABLE 4 : Continue...

Parameter No.	Parameter	3P 4W	3P 3W	1P 2W	Trip Point Set Range	100% Value
664	kVA Max demand System 4	✓	✓	✗	10-120%	Nom ⁽¹⁾
665	Current Max demand System 1	✓	✓	✗	10-120%	Inom
666	Current Max demand System 2	✓	✓	✗	10-120%	Inom
667	Current Max demand System 3	✓	✓	✗	10-120%	Inom
668	Current Max demand System 4	✓	✓	✗	10-120%	Inom
731	Neutral Current System 1	✓	✗	✗	10-120%	Inom
732	Neutral Current System 2	✓	✗	✗	10-120%	Inom
733	Neutral Current System 3	✓	✗	✗	10-120%	Inom
734	Neutral Current System 4	✓	✗	✗	10-120%	Inom
735	Frequency	✓	✓	✓	10-90%	66 Hz ⁽²⁾
736	Relay Manually OFF	✓	✓	✓	1	-
737	Relay Manually ON	✓	✓	✓	1	-

Note 1: (1) Nominal value for power is calculated from nominal voltage and current values and this nominal value is to be considered with set CT/PT Primary values.

(2) For Frequency 0% corresponds to 45 Hz and 100% corresponds to 66 Hz.

Note 2: System 1 parameter represents Three Phase system present at channel 1,2, and 3. Similarly System 2 parameter represents Three Phase system present at channel 4,5,6 and so on.

Note 3: If a channel is not a part of Three Phase system, then the corresponding system parameter will show value 0.

Note 4: If a channel is selected in RCM mode, then only parameter no. 0 to 18 and 735 to 737 of corresponding channel are valid.

5.3 Timer Output

Timer output can be used to operate the Relay in a cyclic manner. The user can define the ON period and OFF period and also the number of times this cycle is to be repeated. The number of Cycles (N) can be indefinite or 1 to 9999. The counting is shown on a measurement screen as explained before.

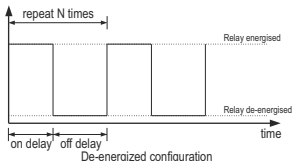
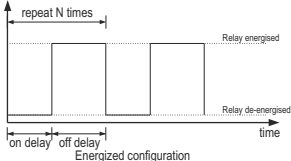

5.4 Tariff

Tariff is used to show Balance energy, Balance cost, Unit cost, Topup Recharge and New Recharge for the energy selected.

For ex:

- 1) Select **Wh import channel 1** in Parameter select (see Section 3.2.8.1.1.1).
- 2) Set Unit Cost as **3.5** (see Section 3.2.8.1.1.2).
- 3) Initially for new meter set new recharge as **1000** (see Section 3.2.8.1.1.4).
- 4) Automatically topup recharge will become **1000** (see Section 3.2.8.1.1.3).
- 5) Balance cost for this energy will **1000**.

$$\begin{aligned} 6) \text{ Balance energy} &= \text{Balance cost} / \text{Unit Cost} \\ &= 1000 / 3.5 \\ &= 285.714 \end{aligned}$$

If remaining Balance cost is 100 out of 1000 and then topup recharge of 1000 is done, then the Balance cost will become 1100.

- Note :**
- 1) If new recharge is done then topup recharge, Balance cost and Balance energy will be reset.
 - 2) If relay mode is changed, then balance cost and balance energy will automatically set according to the topup recharge.

5.5 Load Health

This is applicable only for Three Phase system. It shows different types of faults related to Three Phase Load connected. Refer Section 3.2.7 for allowed limit setting and Section 3.2.6.1.1.4 for relay assignment setting.

Types of faults shown:

- | | | |
|----------------------|----------------------|-------------------|
| 1) over current | 2) over voltage | 3) under voltage |
| 4) under frequency | 5) Phase fail | 6) Phase reversal |
| 7) Unbalance current | 8) Unbalance voltage | |

Note : The relay tripping functionality should be used for indicative purpose only as it does not involve hysteresis or delays.

TABLE 5 : Time - based Datalogging Parameters List

Para. No.	Parameter	3P 4W	3P 3W	1P 2W
0	None	✓	✓	✓
1	Voltage L1	✓	✓	✓
2	Voltage L2	✓	✓	✓
3	Voltage L3	✓	✓	✓
4	Voltage L12	✓	✓	✓
5	Voltage L23	✓	✓	✓
6	Voltage L31	✓	✓	✓
7	Current Channel 1	✓	✓	✓
8	Current Channel 2	✓	✓	✓
9	Current Channel 3	✓	✓	✓
10	Current Channel 4	✓	✓	✓
11	Current Channel 5	✓	✓	✓
12	Current Channel 6	✓	✓	✓
13	Current Channel 7	✓	✓	✓
14	Current Channel 8	✓	✓	✓
15	Current Channel 9	✓	✓	✓
16	Current Channel 10	✓	✓	✓
17	Current Channel 11	✓	✓	✓
18	Current Channel 12	✓	✓	✓
19	W Channel 1	✓	✗	✓
20	W Channel 2	✓	✗	✓
21	W Channel 3	✓	✗	✓
22	W Channel 4	✓	✗	✓
23	W Channel 5	✓	✗	✓
24	W Channel 6	✓	✗	✓
25	W Channel 7	✓	✗	✓
26	W Channel 8	✓	✗	✓
27	W Channel 9	✓	✗	✓
28	W Channel 10	✓	✗	✓
29	W Channel 11	✓	✗	✓

TABLE 5 : Continue...

Para. No.	Parameter	3P 4W	3P 3W	1P 2W
30	W Channel 12	✓	✗	✓
31	VA Channel 1	✓	✗	✓
32	VA Channel 2	✓	✗	✓
33	VA Channel 3	✓	✗	✓
34	VA Channel 4	✓	✗	✓
35	VA Channel 5	✓	✗	✓
36	VA Channel 6	✓	✗	✓
37	VA Channel 7	✓	✗	✓
38	VA Channel 8	✓	✗	✓
39	VA Channel 9	✓	✗	✓
40	VA Channel 10	✓	✗	✓
41	VA Channel 11	✓	✗	✓
42	VA Channel 12	✓	✗	✓
43	VAr Channel 1	✓	✗	✓
44	VAr Channel 2	✓	✗	✓
45	VAr Channel 3	✓	✗	✓
46	VAr Channel 4	✓	✗	✓
47	VAr Channel 5	✓	✗	✓
48	VAr Channel 6	✓	✗	✓
49	VAr Channel 7	✓	✗	✓
50	VAr Channel 8	✓	✗	✓
51	VAr Channel 9	✓	✗	✓
52	VAr Channel 10	✓	✗	✓
53	VAr Channel 11	✓	✗	✓
54	VAr Channel 12	✓	✗	✓
55	PF Channel 1	✓	✗	✓
56	PF Channel 2	✓	✗	✓
57	PF Channel 3	✓	✗	✓
58	PF Channel 4	✓	✗	✓
59	PF Channel 5	✓	✗	✓

TABLE 5 : Continue...

Para. No.	Parameter	3P 4W	3P 3W	1P 2W
60	PF Channel 6	✓	✗	✓
61	PF Channel 7	✓	✗	✓
62	PF Channel 8	✓	✗	✓
63	PF Channel 9	✓	✗	✓
64	PF Channel 10	✓	✗	✓
65	PF Channel 11	✓	✗	✓
66	PF Channel 12	✓	✗	✓
67	Angle Channel 1	✓	✗	✓
68	Angle Channel 2	✓	✗	✓
69	Angle Channel 3	✓	✗	✓
70	Angle Channel 4	✓	✗	✓
71	Angle Channel 5	✓	✗	✓
72	Angle Channel 6	✓	✗	✓
73	Angle Channel 7	✓	✗	✓
74	Angle Channel 8	✓	✗	✓
75	Angle Channel 9	✓	✗	✓
76	Angle Channel 10	✓	✗	✓
77	Angle Channel 11	✓	✗	✓
78	Angle Channel 12	✓	✗	✓
79	Wh Import Channel 1	✓	✗	✓
80	Wh Import Channel 2	✓	✗	✓
81	Wh Import Channel 3	✓	✗	✓
82	Wh Import Channel 4	✓	✗	✓
83	Wh Import Channel 5	✓	✗	✓
84	Wh Import Channel 6	✓	✗	✓
85	Wh Import Channel 7	✓	✗	✓
86	Wh Import Channel 8	✓	✗	✓
87	Wh Import Channel 9	✓	✗	✓
88	Wh Import Channel 10	✓	✗	✓
89	Wh Import Channel 11	✓	✗	✓

TABLE 5 : Continue...

Para. No.	Parameter	3P 4W	3P 3W	1P 2W
90	Wh Import Channel 12	✓	✗	✓
91	Wh Export Channel 1	✓	✗	✓
92	Wh Export Channel 2	✓	✗	✓
93	Wh Export Channel 3	✓	✗	✓
94	Wh Export Channel 4	✓	✗	✓
95	Wh Export Channel 5	✓	✗	✓
96	Wh Export Channel 6	✓	✗	✓
97	Wh Export Channel 7	✓	✗	✓
98	Wh Export Channel 8	✓	✗	✓
99	Wh Export Channel 9	✓	✗	✓
100	Wh Export Channel 10	✓	✗	✓
101	Wh Export Channel 11	✓	✗	✓
102	Wh Export Channel 12	✓	✗	✓
103	VARh Capacitive Channel 1	✓	✗	✓
104	VARh Capacitive Channel 2	✓	✗	✓
105	VARh Capacitive Channel 3	✓	✗	✓
106	VARh Capacitive Channel 4	✓	✗	✓
107	VARh Capacitive Channel 5	✓	✗	✓
108	VARh Capacitive Channel 6	✓	✗	✓
109	VARh Capacitive Channel 7	✓	✗	✓
110	VARh Capacitive Channel 8	✓	✗	✓
111	VARh Capacitive Channel 9	✓	✗	✓
112	VARh Capacitive Channel 10	✓	✗	✓
113	VARh Capacitive Channel 11	✓	✗	✓
114	VARh Capacitive Channel 12	✓	✗	✓
115	VARh Inductive Channel 1	✓	✗	✓
116	VARh Inductive Channel 2	✓	✗	✓
117	VARh Inductive Channel 3	✓	✗	✓
118	VARh Inductive Channel 4	✓	✗	✓
119	VARh Inductive Channel 5	✓	✗	✓

TABLE 5 : Continue...

Para. No.	Parameter	3P 4W	3P 3W	1P 2W
120	VArh Inductive Channel 6	✓	✗	✓
121	VArh Inductive Channel 7	✓	✗	✓
122	VArh Inductive Channel 8	✓	✗	✓
123	VArh Inductive Channel 9	✓	✗	✓
124	VArh Inductive Channel 10	✓	✗	✓
125	VArh Inductive Channel 11	✓	✗	✓
126	VArh Inductive Channel 12	✓	✗	✓
127	VAh Channel 1	✓	✗	✓
128	VAh Channel 2	✓	✗	✓
129	VAh Channel 3	✓	✗	✓
130	VAh Channel 4	✓	✗	✓
131	VAh Channel 5	✓	✗	✓
132	VAh Channel 6	✓	✗	✓
133	VAh Channel 7	✓	✗	✓
134	VAh Channel 8	✓	✗	✓
135	VAh Channel 9	✓	✗	✓
136	VAh Channel 10	✓	✗	✓
137	VAh Channel 11	✓	✗	✓
138	VAh Channel 12	✓	✗	✓
139	Wh Import overflow count Channel 1	✓	✗	✓
140	Wh Import overflow count Channel 2	✓	✗	✓
141	Wh Import overflow count Channel 3	✓	✗	✓
142	Wh Import overflow count Channel 4	✓	✗	✓
143	Wh Import overflow count Channel 5	✓	✗	✓
144	Wh Import overflow count Channel 6	✓	✗	✓
145	Wh Import overflow count Channel 7	✓	✗	✓
146	Wh Import overflow count Channel 8	✓	✗	✓
147	Wh Import overflow count Channel 9	✓	✗	✓
148	Wh Import overflow count Channel 10	✓	✗	✓
149	Wh Import overflow count Channel 11	✓	✗	✓

TABLE 5 : Continue...

Para. No.	Parameter	3P 4W	3P 3W	1P 2W
150	Wh Import overflow count Channel 12	✓	✗	✓
151	Wh Export overflow count Channel 1	✓	✗	✓
152	Wh Export overflow count Channel 2	✓	✗	✓
153	Wh Export overflow count Channel 3	✓	✗	✓
154	Wh Export overflow count Channel 4	✓	✗	✓
155	Wh Export overflow count Channel 5	✓	✗	✓
156	Wh Export overflow count Channel 6	✓	✗	✓
157	Wh Export overflow count Channel 7	✓	✗	✓
158	Wh Export overflow count Channel 8	✓	✗	✓
159	Wh Export overflow count Channel 9	✓	✗	✓
160	Wh Export overflow count Channel 10	✓	✗	✓
161	Wh Export overflow count Channel 11	✓	✗	✓
162	Wh Export overflow count Channel 12	✓	✗	✓
163	VARh Capacitive overflow count Channel 1	✓	✗	✓
164	VARh Capacitive overflow count Channel 2	✓	✗	✓
165	VARh Capacitive overflow count Channel 3	✓	✗	✓
166	VARh Capacitive overflow count Channel 4	✓	✗	✓
167	VARh Capacitive overflow count Channel 5	✓	✗	✓
168	VARh Capacitive overflow count Channel 6	✓	✗	✓
169	VARh Capacitive overflow count Channel 7	✓	✗	✓
170	VARh Capacitive overflow count Channel 8	✓	✗	✓
171	VARh Capacitive overflow count Channel 9	✓	✗	✓
172	VARh Capacitive overflow count Channel 10	✓	✗	✓
173	VARh Capacitive overflow count Channel 11	✓	✗	✓
174	VARh Capacitive overflow count Channel 12	✓	✗	✓
175	VARh Inductive overflow count Channel 1	✓	✗	✓
176	VARh Inductive overflow count Channel 2	✓	✗	✓
177	VARh Inductive overflow count Channel 3	✓	✗	✓
178	VARh Inductive overflow count Channel 4	✓	✗	✓
179	VARh Inductive overflow count Channel 5	✓	✗	✓

TABLE 5 : Continue...

Para. No.	Parameter	3P 4W	3P 3W	1P 2W
180	VArh Inductive overflow count Channel 6	✓	✗	✓
181	VArh Inductive overflow count Channel 7	✓	✗	✓
182	VArh Inductive overflow count Channel 8	✓	✗	✓
183	VArh Inductive overflow count Channel 9	✓	✗	✓
184	VArh Inductive overflow count Channel 10	✓	✗	✓
185	VArh Inductive overflow count Channel 11	✓	✗	✓
186	VArh Inductive overflow count Channel 12	✓	✗	✓
187	VAh overflow count Channel 1	✓	✗	✓
188	VAh overflow count Channel 2	✓	✗	✓
189	VAh overflow count Channel 3	✓	✗	✓
190	VAh overflow count Channel 4	✓	✗	✓
191	VAh overflow count Channel 5	✓	✗	✓
192	VAh overflow count Channel 6	✓	✗	✓
193	VAh overflow count Channel 7	✓	✗	✓
194	VAh overflow count Channel 8	✓	✗	✓
195	VAh overflow count Channel 9	✓	✗	✓
196	VAh overflow count Channel 10	✓	✗	✓
197	VAh overflow count Channel 11	✓	✗	✓
198	VAh overflow count Channel 12	✓	✗	✓
199	kW Import demand Channel 1	✓	✗	✓
200	kW Import demand Channel 2	✓	✗	✓
201	kW Import demand Channel 3	✓	✗	✓
202	kW Import demand Channel 4	✓	✗	✓
203	kW Import demand Channel 5	✓	✗	✓
204	kW Import demand Channel 6	✓	✗	✓
205	kW Import demand Channel 7	✓	✗	✓
206	kW Import demand Channel 8	✓	✗	✓
207	kW Import demand Channel 9	✓	✗	✓
208	kW Import demand Channel 10	✓	✗	✓
209	kW Import demand Channel 11	✓	✗	✓

TABLE 5 : Continue...

Para. No.	Parameter	3P 4W	3P 3W	1P 2W
210	kW Import demand Channel 12	✓	✗	✓
211	kW Export demand Channel 1	✓	✗	✓
212	kW Export demand Channel 2	✓	✗	✓
213	kW Export demand Channel 3	✓	✗	✓
214	kW Export demand Channel 4	✓	✗	✓
215	kW Export demand Channel 5	✓	✗	✓
216	kW Export demand Channel 6	✓	✗	✓
217	kW Export demand Channel 7	✓	✗	✓
218	kW Export demand Channel 8	✓	✗	✓
219	kW Export demand Channel 9	✓	✗	✓
220	kW Export demand Channel 10	✓	✗	✓
221	kW Export demand Channel 11	✓	✗	✓
222	kW Export demand Channel 12	✓	✗	✓
223	kVAr Capacitive demand Channel 1	✓	✗	✓
224	kVAr Capacitive demand Channel 2	✓	✗	✓
225	kVAr Capacitive demand Channel 3	✓	✗	✓
226	kVAr Capacitive demand Channel 4	✓	✗	✓
227	kVAr Capacitive demand Channel 5	✓	✗	✓
228	kVAr Capacitive demand Channel 6	✓	✗	✓
229	kVAr Capacitive demand Channel 7	✓	✗	✓
230	kVAr Capacitive demand Channel 8	✓	✗	✓
231	kVAr Capacitive demand Channel 9	✓	✗	✓
232	kVAr Capacitive demand Channel 10	✓	✗	✓
233	kVAr Capacitive demand Channel 11	✓	✗	✓
234	kVAr Capacitive demand Channel 12	✓	✗	✓
235	kVAr Inductive demand Channel 1	✓	✗	✓
236	kVAr Inductive demand Channel 2	✓	✗	✓
237	kVAr Inductive demand Channel 3	✓	✗	✓
238	kVAr Inductive demand Channel 4	✓	✗	✓
239	kVAr Inductive demand Channel 5	✓	✗	✓

TABLE 5 : Continue...

Para. No.	Parameter	3P 4W	3P 3W	1P 2W
240	kVAr Inductive demand Channel 6	✓	✗	✓
241	kVAr Inductive demand Channel 7	✓	✗	✓
242	kVAr Inductive demand Channel 8	✓	✗	✓
243	kVAr Inductive demand Channel 9	✓	✗	✓
244	kVAr Inductive demand Channel 10	✓	✗	✓
245	kVAr Inductive demand Channel 11	✓	✗	✓
246	kVAr Inductive demand Channel 12	✓	✗	✓
247	kVA demand Channel 1	✓	✗	✓
248	kVA demand Channel 2	✓	✗	✓
249	kVA demand Channel 3	✓	✗	✓
250	kVA demand Channel 4	✓	✗	✓
251	kVA demand Channel 5	✓	✗	✓
252	kVA demand Channel 6	✓	✗	✓
253	kVA demand Channel 7	✓	✗	✓
254	kVA demand Channel 8	✓	✗	✓
255	kVA demand Channel 9	✓	✗	✓
256	kVA demand Channel 10	✓	✗	✓
257	kVA demand Channel 11	✓	✗	✓
258	kVA demand Channel 12	✓	✗	✓
259	Current demand Channel 1	✓	✗	✓
260	Current demand Channel 2	✓	✗	✓
261	Current demand Channel 3	✓	✗	✓
262	Current demand Channel 4	✓	✗	✓
263	Current demand Channel 5	✓	✗	✓
264	Current demand Channel 6	✓	✗	✓
265	Current demand Channel 7	✓	✗	✓
266	Current demand Channel 8	✓	✗	✓
267	Current demand Channel 9	✓	✗	✓
268	Current demand Channel 10	✓	✗	✓
269	Current demand Channel 11	✓	✗	✓

TABLE 5 : Continue...

Para. No.	Parameter	3P 4W	3P 3W	1P 2W
270	Current demand Channel 12	✓	✗	✓
271	kW Import Max demand Channel 1	✓	✗	✓
272	kW Import Max demand Channel 2	✓	✗	✓
273	kW Import Max demand Channel 3	✓	✗	✓
274	kW Import Max demand Channel 4	✓	✗	✓
275	kW Import Max demand Channel 5	✓	✗	✓
276	kW Import Max demand Channel 6	✓	✗	✓
277	kW Import Max demand Channel 7	✓	✗	✓
278	kW Import Max demand Channel 8	✓	✗	✓
279	kW Import Max demand Channel 9	✓	✗	✓
280	kW Import Max demand Channel 10	✓	✗	✓
281	kW Import Max demand Channel 11	✓	✗	✓
282	kW Import Max demand Channel 12	✓	✗	✓
283	kW Export Max demand Channel 1	✓	✗	✓
284	kW Export Max demand Channel 2	✓	✗	✓
285	kW Export Max demand Channel 3	✓	✗	✓
286	kW Export Max demand Channel 4	✓	✗	✓
287	kW Export Max demand Channel 5	✓	✗	✓
288	kW Export Max demand Channel 6	✓	✗	✓
289	kW Export Max demand Channel 7	✓	✗	✓
290	kW Export Max demand Channel 8	✓	✗	✓
291	kW Export Max demand Channel 9	✓	✗	✓
292	kW Export Max demand Channel 10	✓	✗	✓
293	kW Export Max demand Channel 11	✓	✗	✓
294	kW Export Max demand Channel 12	✓	✗	✓
295	kVAr Capacitive Max demand Channel 1	✓	✗	✓
296	kVAr Capacitive Max demand Channel 2	✓	✗	✓
297	kVAr Capacitive Max demand Channel 3	✓	✗	✓
298	kVAr Capacitive Max demand Channel 4	✓	✗	✓
299	kVAr Capacitive Max demand Channel 5	✓	✗	✓

TABLE 5 : Continue...

Para. No.	Parameter	3P 4W	3P 3W	1P 2W
300	kVAr Capacitive Max demand Channel 6	✓	✗	✓
301	kVAr Capacitive Max demand Channel 7	✓	✗	✓
302	kVAr Capacitive Max demand Channel 8	✓	✗	✓
303	kVAr Capacitive Max demand Channel 9	✓	✗	✓
304	kVAr Capacitive Max demand Channel 10	✓	✗	✓
305	kVAr Capacitive Max demand Channel 11	✓	✗	✓
306	kVAr Capacitive Max demand Channel 12	✓	✗	✓
307	kVAr Inductive Max demand Channel 1	✓	✗	✓
308	kVAr Inductive Max demand Channel 2	✓	✗	✓
309	kVAr Inductive Max demand Channel 3	✓	✗	✓
310	kVAr Inductive Max demand Channel 4	✓	✗	✓
311	kVAr Inductive Max demand Channel 5	✓	✗	✓
312	kVAr Inductive Max demand Channel 6	✓	✗	✓
313	kVAr Inductive Max demand Channel 7	✓	✗	✓
314	kVAr Inductive Max demand Channel 8	✓	✗	✓
315	kVAr Inductive Max demand Channel 9	✓	✗	✓
316	kVAr Inductive Max demand Channel 10	✓	✗	✓
317	kVAr Inductive Max demand Channel 11	✓	✗	✓
318	kVAr Inductive Max demand Channel 12	✓	✗	✓
319	kVA Max demand Channel 1	✓	✗	✓
320	kVA Max demand Channel 2	✓	✗	✓
321	kVA Max demand Channel 3	✓	✗	✓
322	kVA Max demand Channel 4	✓	✗	✓
323	kVA Max demand Channel 5	✓	✗	✓
324	kVA Max demand Channel 6	✓	✗	✓
325	kVA Max demand Channel 7	✓	✗	✓
326	kVA Max demand Channel 8	✓	✗	✓
327	kVA Max demand Channel 9	✓	✗	✓
328	kVA Max demand Channel 10	✓	✗	✓
329	kVA Max demand Channel 11	✓	✗	✓

TABLE 5 : Continue...

Para. No.	Parameter	3P 4W	3P 3W	1P 2W
330	kVA Max demand Channel 12	✓	✗	✓
331	Current Max demand Channel 1	✓	✗	✓
332	Current Max demand Channel 2	✓	✗	✓
333	Current Max demand Channel 3	✓	✗	✓
334	Current Max demand Channel 4	✓	✗	✓
335	Current Max demand Channel 5	✓	✗	✓
336	Current Max demand Channel 6	✓	✗	✓
337	Current Max demand Channel 7	✓	✗	✓
338	Current Max demand Channel 8	✓	✗	✓
339	Current Max demand Channel 9	✓	✗	✓
340	Current Max demand Channel 10	✓	✗	✓
341	Current Max demand Channel 11	✓	✗	✓
342	Current Max demand Channel 12	✓	✗	✓
463	Max Voltage L1	✓	✓	✓
464	Max Voltage L2	✓	✓	✓
465	Max Voltage L3	✓	✓	✓
466	Min Voltage L1	✓	✓	✓
467	Min Voltage L2	✓	✓	✓
468	Min Voltage L3	✓	✓	✓
469	Max Voltage L12	✓	✓	✓
470	Max Voltage L23	✓	✓	✓
471	Max Voltage L31	✓	✓	✓
472	Min Voltage L12	✓	✓	✓
473	Min Voltage L23	✓	✓	✓
474	Min Voltage L31	✓	✓	✓
475	Max Current Channel 1	✓	✓	✓
476	Max Current Channel 2	✓	✓	✓
477	Max Current Channel 3	✓	✓	✓
478	Max Current Channel 4	✓	✓	✓
479	Max Current Channel 5	✓	✓	✓

TABLE 5 : Continue...

Para. No.	Parameter	3P 4W	3P 3W	1P 2W
480	Max Current Channel 6	✓	✓	✓
481	Max Current Channel 7	✓	✓	✓
482	Max Current Channel 8	✓	✓	✓
483	Max Current Channel 9	✓	✓	✓
484	Max Current Channel 10	✓	✓	✓
485	Max Current Channel 11	✓	✓	✓
486	Max Current Channel 12	✓	✓	✓
487	Min Current Channel 1	✓	✓	✓
488	Min Current Channel 2	✓	✓	✓
489	Min Current Channel 3	✓	✓	✓
490	Min Current Channel 4	✓	✓	✓
491	Min Current Channel 5	✓	✓	✓
492	Min Current Channel 6	✓	✓	✓
493	Min Current Channel 7	✓	✓	✓
494	Min Current Channel 8	✓	✓	✓
495	Min Current Channel 9	✓	✓	✓
496	Min Current Channel 10	✓	✓	✓
497	Min Current Channel 11	✓	✓	✓
498	Min Current Channel 12	✓	✓	✓
499	Run hour Channel 1	✓	✗	✓
500	Run hour Channel 2	✓	✗	✓
501	Run hour Channel 3	✓	✗	✓
502	Run hour Channel 4	✓	✗	✓
503	Run hour Channel 5	✓	✗	✓
504	Run hour Channel 6	✓	✗	✓
505	Run hour Channel 7	✓	✗	✓
506	Run hour Channel 8	✓	✗	✓
507	Run hour Channel 9	✓	✗	✓
508	Run hour Channel 10	✓	✗	✓
509	Run hour Channel 11	✓	✗	✓

TABLE 5 : Continue...

Para. No.	Parameter	3P 4W	3P 3W	1P 2W
510	Run hour Channel 12	✓	✓	✓
511	Voltage L1 THD	✓	✓	✓
512	Voltage L2 THD	✓	✓	✓
513	Voltage L3 THD	✓	✓	✓
514	Voltage L12 THD	✓	✓	✓
515	Voltage L23 THD	✓	✓	✓
516	Voltage L31 THD	✓	✓	✓
517	Current THD Channel 1	✓	✓	✓
518	Current THD Channel 2	✓	✓	✓
519	Current THD Channel 3	✓	✓	✓
520	Current THD Channel 4	✓	✓	✓
521	Current THD Channel 5	✓	✓	✓
522	Current THD Channel 6	✓	✓	✓
523	Current THD Channel 7	✓	✓	✓
524	Current THD Channel 8	✓	✓	✓
525	Current THD Channel 9	✓	✓	✓
526	Current THD Channel 10	✓	✓	✓
527	Current THD Channel 11	✓	✓	✓
528	Current THD Channel 12	✓	✓	✓
529	System Voltage LN Avg	✓	✓	✓
531	System Voltage LL Avg	✓	✓	✓
533	Current Avg System 1	✓	✓	✗
534	Current Avg System 2	✓	✓	✗
535	Current Avg System 3	✓	✓	✗
536	Current Avg System 4	✓	✓	✗
545	Watt Sum System 1	✓	✓	✗
546	Watt Sum System 2	✓	✓	✗
547	Watt Sum System 3	✓	✓	✗
548	Watt Sum System 4	✓	✓	✗
553	VA Sum System 1	✓	✓	✗

TABLE 5 : Continue...

Para. No.	Parameter	3P 4W	3P 3W	1P 2W
554	VA Sum System 2	✓	✓	✗
555	VA Sum System 3	✓	✓	✗
556	VA Sum System 4	✓	✓	✗
561	VAr Sum System 1	✓	✓	✗
562	VAr Sum System 2	✓	✓	✗
563	VAr Sum System 3	✓	✓	✗
564	VAr Sum System 4	✓	✓	✗
565	PF Avg System 1	✓	✓	✗
566	PF Avg System 2	✓	✓	✗
567	PF Avg System 3	✓	✓	✗
568	PF Avg System 4	✓	✓	✗
573	Phase Angle Avg System 1	✓	✓	✗
574	Phase Angle Avg System 2	✓	✓	✗
575	Phase Angle Avg System 3	✓	✓	✗
576	Phase Angle Avg System 4	✓	✓	✗
581	Wh Import System 1	✓	✓	✗
582	Wh Import System 2	✓	✓	✗
583	Wh Import System 3	✓	✓	✗
584	Wh Import System 4	✓	✓	✗
585	Wh Export System 1	✓	✓	✗
586	Wh Export System 2	✓	✓	✗
587	Wh Export System 3	✓	✓	✗
588	Wh Export System 4	✓	✓	✗
589	VArh Capacitive System 1	✓	✓	✗
590	VArh Capacitive System 2	✓	✓	✗
591	VArh Capacitive System 3	✓	✓	✗
592	VArh Capacitive System 4	✓	✓	✗
593	VArh Inductive System 1	✓	✓	✗
594	VArh Inductive System 2	✓	✓	✗
595	VArh Inductive System 3	✓	✓	✗

TABLE 5 : Continue...

Para. No.	Parameter	3P 4W	3P 3W	1P 2W
596	VArh Inductive System 4	✓	✓	✗
597	VAh System 1	✓	✓	✗
598	VAh System 2	✓	✓	✗
599	VAh System 3	✓	✓	✗
600	VAh System 4	✓	✓	✗
601	Wh Import overflow count System 1	✓	✓	✗
602	Wh Import overflow count System 2	✓	✓	✗
603	Wh Import overflow count System 3	✓	✓	✗
604	Wh Import overflow count System 4	✓	✓	✗
605	Wh Export overflow count System 1	✓	✓	✗
606	Wh Export overflow count System 2	✓	✓	✗
607	Wh Export overflow count System 3	✓	✓	✗
608	Wh Export overflow count System 4	✓	✓	✗
609	VArh Capacitive overflow count System 1	✓	✓	✗
610	VArh Capacitive overflow count System 2	✓	✓	✗
611	VArh Capacitive overflow count System 3	✓	✓	✗
612	VArh Capacitive overflow count System 4	✓	✓	✗
613	VArh Inductive overflow count System 1	✓	✓	✗
614	VArh Inductive overflow count System 2	✓	✓	✗
615	VArh Inductive overflow count System 3	✓	✓	✗
616	VArh Inductive overflow count System 4	✓	✓	✗
617	VAh overflow count System 1	✓	✓	✗
618	VAh overflow count System 2	✓	✓	✗
619	VAh overflow count System 3	✓	✓	✗
620	VAh overflow count System 4	✓	✓	✗
621	kW Import demand System 1	✓	✓	✗
622	kW Import demand System 2	✓	✓	✗
623	kW Import demand System 3	✓	✓	✗
624	kW Import demand System 4	✓	✓	✗
625	kW Export demand System 1	✓	✓	✗

TABLE 5 : Continue...

Para. No.	Parameter	3P 4W	3P 3W	1P 2W
626	kW Export demand System 2	✓	✓	✗
627	kW Export demand System 3	✓	✓	✗
628	kW Export demand System 4	✓	✓	✗
629	kVAr Capacitive demand System 1	✓	✓	✗
630	kVAr Capacitive demand System 2	✓	✓	✗
631	kVAr Capacitive demand System 3	✓	✓	✗
632	kVAr Capacitive demand System 4	✓	✓	✗
633	kVAr Inductive demand System 1	✓	✓	✗
634	kVAr Inductive demand System 2	✓	✓	✗
635	kVAr Inductive demand System 3	✓	✓	✗
636	kVAr Inductive demand System 4	✓	✓	✗
637	KVA demand System 1	✓	✓	✗
638	KVA demand System 2	✓	✓	✗
639	KVA demand System 3	✓	✓	✗
640	KVA demand System 4	✓	✓	✗
641	Current demand System 1	✓	✓	✗
642	Current demand System 2	✓	✓	✗
643	Current demand System 3	✓	✓	✗
644	Current demand System 4	✓	✓	✗
645	kW Import Max demand System 1	✓	✓	✗
646	kW Import Max demand System 2	✓	✓	✗
647	kW Import Max demand System 3	✓	✓	✗
648	kW Import Max demand System 4	✓	✓	✗
649	KW Export Max demand System 1	✓	✓	✗
650	KW Export Max demand System 2	✓	✓	✗
651	KW Export Max demand System 3	✓	✓	✗
652	KW Export Max demand System 4	✓	✓	✗
653	kVAr Capacitive Max demand System 1	✓	✓	✗
654	kVAr Capacitive Max demand System 2	✓	✓	✗
655	kVAr Capacitive Max demand System 3	✓	✓	✗

TABLE 5 : Continue...

Para. No.	Parameter	3P 4W	3P 3W	1P 2W
656	kVAr Capacitive Max demand System 4	✓	✓	✗
657	kVAr Inductive Max demand System 1	✓	✓	✗
658	kVAr Inductive Max demand System 2	✓	✓	✗
659	kVAr Inductive Max demand System 3	✓	✓	✗
660	kVAr Inductive Max demand System 4	✓	✓	✗
661	kVA Max demand System 1	✓	✓	✗
662	kVA Max demand System 2	✓	✓	✗
663	kVA Max demand System 3	✓	✓	✗
664	kVA Max demand System 4	✓	✓	✗
665	Current Max demand System 1	✓	✓	✗
666	Current Max demand System 2	✓	✓	✗
667	Current Max demand System 3	✓	✓	✗
668	Current Max demand System 4	✓	✓	✗
709	System Max Voltage LN	✓	✓	✓
710	System Min Voltage LN	✓	✓	✓
711	System Max Voltage LL	✓	✓	✓
712	System Min Voltage LL	✓	✓	✓
713	Max Current System 1	✓	✓	✗
714	Max Current System 2	✓	✓	✗
715	Max Current System 3	✓	✓	✗
716	Max Current System 4	✓	✓	✗
717	Min Current System 1	✓	✓	✗
718	Min Current System 2	✓	✓	✗
719	Min Current System 3	✓	✓	✗
720	Min Current System 4	✓	✓	✗
721	Run hour System 1	✓	✓	✗
722	Run hour System 2	✓	✓	✗
723	Run hour System 3	✓	✓	✗
724	Run hour System 4	✓	✓	✗
725	System VLN-THD	✓	✓	✓

TABLE 5 : Continue...

Para. No.	Parameter	3P 4W	3P 3W	1P 2W
726	System VLL-THD	✓	✓	✓
727	I-THD System 1	✓	✓	✗
728	I-THD System 2	✓	✓	✗
729	I-THD System 3	✓	✓	✗
730	I-THD System 4	✓	✓	✗
731	Neutral Current System 1	✓	✗	✗
732	Neutral Current System 2	✓	✗	✗
733	Neutral Current System 3	✓	✗	✗
734	Neutral Current System 4	✓	✗	✗
735	Frequency	✓	✓	✓
736	RPM	✓	✓	✓
737	Instrument ON Hour	✓	✓	✓
738	Instrument No of Interruption	✓	✓	✓
739	Total System Voltage LN avg	These parameters do not depend upon channel mode		
740	Total System Voltage LL avg			
741	Total System Current avg			
742	Total System Active Power sum			
743	Total System Reactive Power sum			
744	Total System Apparent Power sum			
745	Total System PF avg			
746	Total System PA avg			
747	Total System Wh Import sum			
748	Total System Wh Export sum			
749	Total System VARh Capacitive sum			
750	Total System VARh Inductive sum			
751	Total System VAh sum			
752	Total System Wh Import overflow count			
753	Total System Wh Export overflow count			
754	Total System VARh Capacitive overflow count			
755	Total System VARh Inductive overflow count			

TABLE 5 : Continue...

Para. No.	Parameter	3P 4W	3P 3W	1P 2W
756	Total System VAh overflow count	These parameters do not depend upon channel mode		
757	Total System kW Import Demand sum			
758	Total System kW Export Demand sum			
759	Total System kVAR Capacitive Demand sum			
760	Total System kVAR Inductive Demand sum			
761	Total System kVA Demand sum			
762	Total System A Demand sum			
763	Total System kW Import Max Demand			
764	Total System kW Export Max Demand			
765	Total System kVAR Capacitive Max Demand			
766	Total System kVAR Inductive Max Demand			
767	Total System kVA Max Demand			
768	Total System A Max Demand			
769	Total System CT Primary			
770	Phase sequence indication	✓	✓	✓

6. Phasor Diagram :

Quadrant 1: 0° to 90°

Quadrant 3: 180° to 270°

Quadrant 2: 90° to 180°

Quadrant 4: 270° to 360°

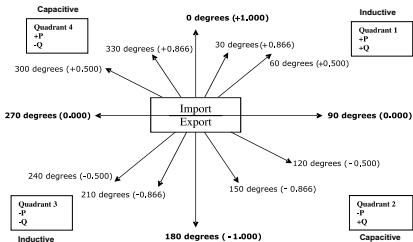

Connections	Quadrant	Sign of Active Power (P)	Sign of Reactive Power (Q)	Sign of Power Factor (PF)	Inductive / Capacitive
Import	1	+ P	+ Q	+	L
Import	4	+ P	- Q	+	C
Export	2	- P	+ Q	-	C
Export	3	- P	- Q	-	L

Inductive means Current lags Voltage

Capacitive means Current leads Voltage

When Multifunction Meter displays Active power (P) with "+" (positive sign), the connection is "**Import**".

When Multifunction Meter displays Active power (P) with "-" (negative sign), the connection is "**Export**".

7. Installation

Mounting of the Meter is featured with easy "Clip-in" mounting. Push the meter in panel slot (size 92 x92 mm), it will click fit into panel with the four integral retention clips on two sides of meter. If required, additional support is provided with swivel screws as shown in figure.

The front of the enclosure conforms to IP54. Additional protection to the panel may be obtained by the use of an Optional panel gasket. The terminals at the rear of the product should be protected from liquids.

The Meter should be mounted in a reasonably stable ambient temperature and where the operating temperature is within the range 0 to 50°C. Vibration should be kept to a minimum and the product should not be mounted where it will be subjected to excessive direct sunlight.

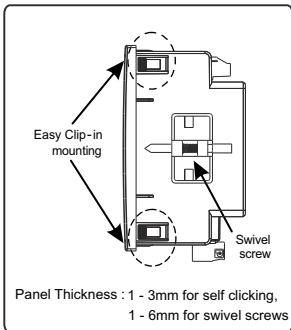

Caution

1. In the interest of safety and functionality this product must be installed by a qualified engineer, abiding by any local regulations.
2. Voltages dangerous to human life are present at some of the terminal connections of this unit. Ensure that all supplies are de-energised before attempting any connection or disconnection.
3. These products do not have internal fuses therefore external fuses must be used to ensure safety under fault conditions.

7.1 EMC Installation Requirements

This product has been designed to meet the certification of the EU directives when installed to a good code of practice for EMC in industrial environments, e.g.

1. Screened output and low signal input leads or have provision for fitting RF suppression components, such as ferrite absorbers, line filters etc., in the event that RF fields cause problems.

Note : It is good practice to install sensitive electronic instruments that are performing critical functions, in EMC enclosures that protect against electrical interference which could cause a disturbance in function.

2. Avoid routing leads alongside cables and products that are, or could be, a source of interference.

3. To protect the product against permanent damage, surge transients must be limited to 2kV pk. It is good EMC practice to suppress differential surges to 2kV at the source. The unit has been designed to automatically recover in the event of a high level of transients. In extreme circumstances it may be necessary to temporarily disconnect the auxiliary supply for a period of greater than 5 seconds to restore correct operation.

The Current inputs of these products are designed for connection to systems via Current Transformers only, where one side is grounded.

4. ESD precautions must be taken at all times when handling this product.

7.2 Case Dimensions and Panel Cut-Out

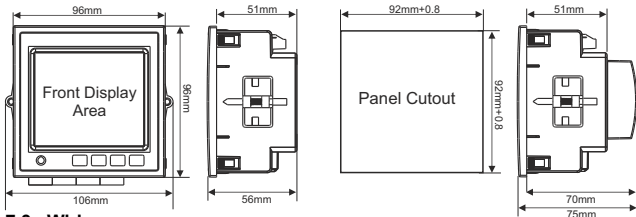

7.3 Wiring

Input connections are made directly to screw-type terminals with indirect wire pressure. Numbering is clearly marked on the connector. Choice of cable should meet local regulations. Terminal for both Current and Voltage inputs will accept upto 4mm² (12AWG) solid or 2.5 mm² stranded cable.

Note : It is recommended to use wire with Pin type for connection with meter.



7.4 Auxiliary Supply

Meter should ideally be powered from a dedicated supply, however powered from the signal source, provided the source remains within it may be the limits of the Chosen auxiliary voltage range.

7.5 Fusing

It is recommended that all voltage lines are fitted with 1 Amp HRC fuses or circuit breaker to disconnecting the device.

Specification : Disconnecting device used must be relevant requirements of IEC-60974-1 & IEC-60947-3

For Aux: At most 1.5 times of applied power supply

For measuring input : At most 1.5 times of measuring input.

(Switching time of the device should be < 0.1 sec for Aux & I/P both)

7.6 Earth/Ground Connections

For safety reasons, CT secondary connections should be grounded in accordance with local regulations.

***Note :** Refer this Manual wherever the CAUTION symbol is marked.

8. Electrical Connection (Backview)

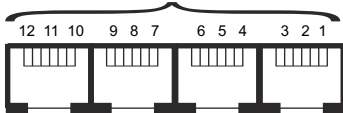
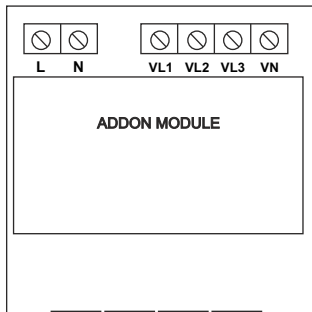

12 CHANNELS FOR CURRENT INPUT

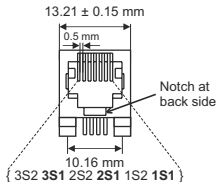

Meter Side RJ12 Connection

Note : A single RJ12 i/p should be used

for one of the following cases :

1. A 'Three Phase' load
2. Max. 3 'Single Phase' loads
3. Max. 3 'CBCTs (for RCM)'

Use Case Scenarios

1. All 3Phase Load Connections with 3Phase RJ12 CT :

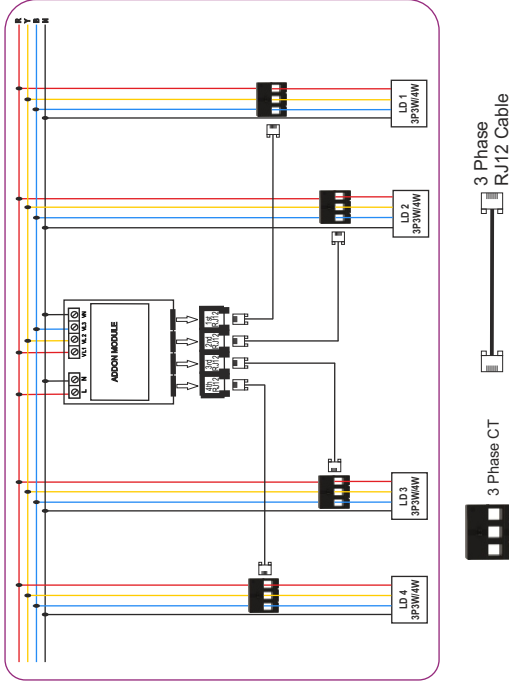

2. All 3Phase Load Connections With 1Phase 5A/1A CT :

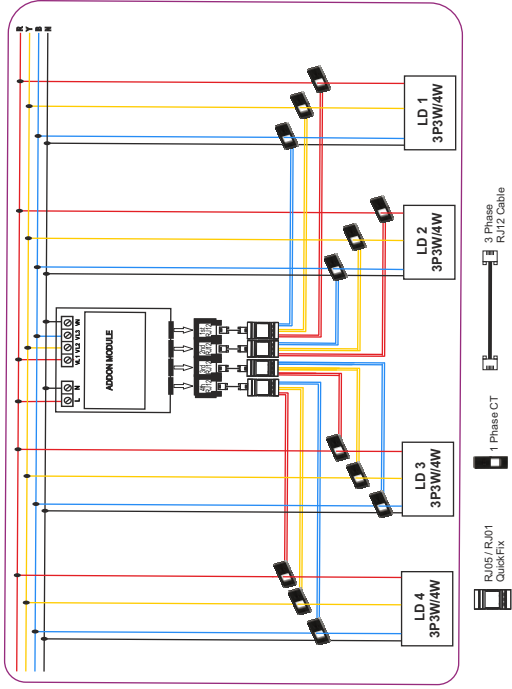

***Note :** User can use 3 phase 5A/1A CT instead of 3x 1 phase 5A/1A CT.

3. All 1Phase Load Connections With 1Phase 5A/1A CT :

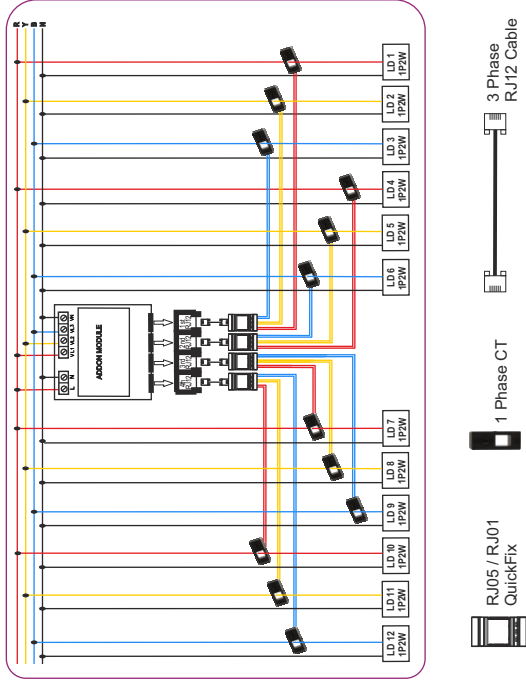

4. All 1Phase Load Connections With 1Phase RJ12 CT :

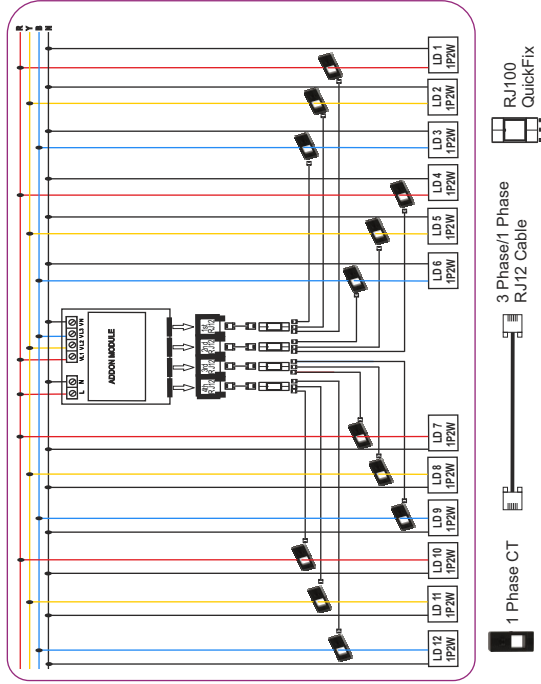

5. All 3Phase Load Plus RCM Connections :

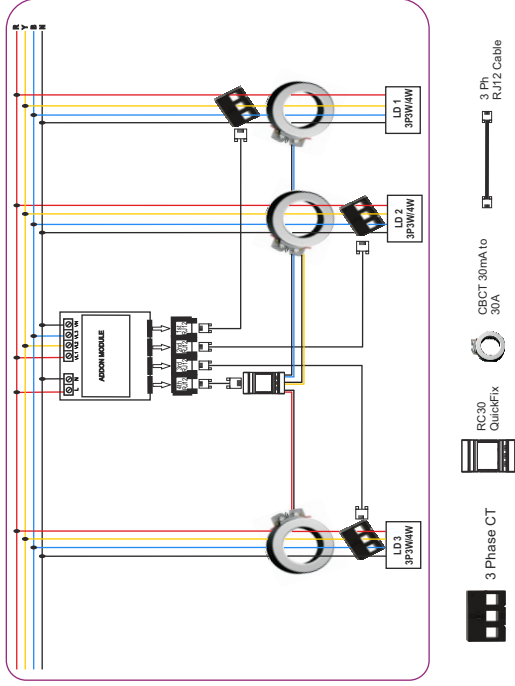

***Note :** User can use 3 phase 5A/1 A CT with "QuickFix 5A/1A to R112 Converter" for above application. Many combinations are possible in above application.

6. All 1Phase 5A/1A CT Plus RCM Connections :

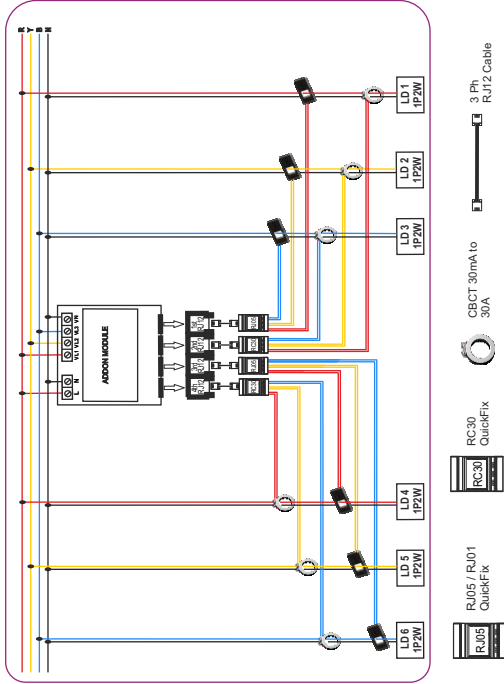

***Note :** User can use 1 phase RJ12 CT with "QuickFix 3x 1Phase RJ12 Converter" for above application. Many combinations are possible in above application.

7. Hybrid Load Connections :

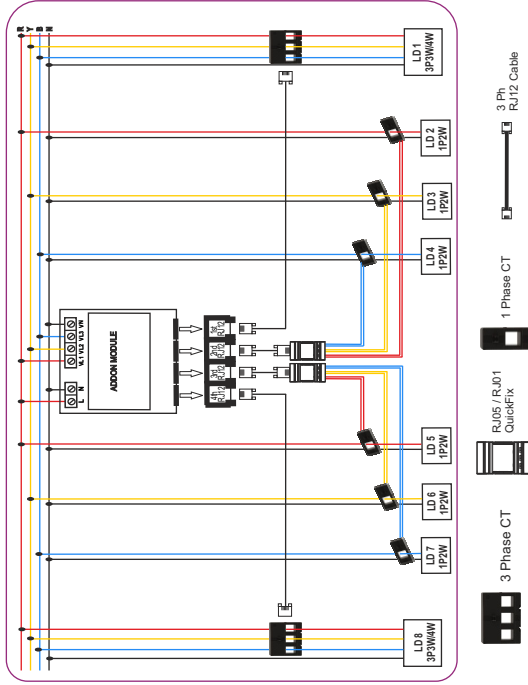

*Note : Many combinations of 1 Phase 3 Phase load along with RCM are possible in above hybrid load connection.

9. Optional Pluggable Module

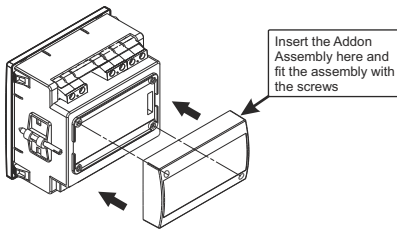

Optional Pluggable (Addon) Module

10. Specification

Channel Mode

3 Phase 3 Wire / 4 Wire or Single Phase or RCM or No Load or any of the combination of these programmable on site

Inputs

Nominal Input Voltage (AC RMS)	100VLL to 600VLL programmable on site. (57.7VLN to 346.4VLN)
System PT Primary Values	100VLL to 1200 kVLL, programmable on site
System PT Secondary Values	100VLL to 600VLL programmable on site (57.7VLN to 346.4VLN)
Max continuous input voltage	120% of Nominal Value
Nominal input voltage burden	< 0.3 VA approx. per Phase (at nominal 240V)
Overload Indication	"-OL-" >121% of Nominal value

Input Current

Nominal Input Current	100mA
Max continuous input current	120% of Nominal value
Nominal input current burden	< 0.05 VA approx. per phase
System CT primary values	Std. Values 1A to 9999A
Overload Indication	"-OL-" >121% of Nominal value

Auxiliary Supply

Auxiliary supply range	100V to 550V AC-DC
Aux Frequency Range	45 to 65 Hz
VA Burden With Addon card	< 8 VA approx. (at nominal) for 2 Relays < 10 VA approx. (at nominal) for 4 Relays
VA Burden With Ethernet card	< 9 VA approx. (at nominal)

Operating Measuring Ranges

Voltage	20 ... 120 % of nominal Value
Current	1....120% of nominal value
Starting Current	Class 1 as per IEC 62053 - 21 Class 0.5S as per IEC 62053 - 22 (optional)
Frequency	45 to 66 Hz
Power Factor	0.5 Lag ... 1 ... 0.8 Lead
Total Harmonic Distortion	50% upto 15th harmonic 10% upto 31st harmonic

Reference Conditions for Accuracy

Reference temperature (as per IEC 62053-21)	23°C \pm 2°C
Input Waveform	Sinusoidal (distortion factor 0.005)
Input Frequency	50 / 60 Hz \pm 2%
Auxiliary supply	230V AC/DC \pm 1%
Auxiliary supply frequency	50 / 60 Hz \pm 1%
Total Harmonic Distortion	50% upto 15th harmonic 10% upto 31st harmonic

Accuracy

Voltage	\pm 0.5% of nominal value
Current	\pm 0.5% of nominal value
Frequency	\pm 0.2 % of mid frequency
Active power	\pm 0.5% of nominal value
Reactive power	\pm 1.0% of nominal value
Apparent Power	\pm 0.5% of nominal value

Power Factor / Phase Angle	$\pm 3^\circ$
Active energy	Class 1 as per IEC 62053 - 21 Class 0.5S as per IEC 62053 - 22 (optional)
Reactive energy	Class 2 as per IEC 62053-23
Apparent energy	Class 1
THD (Voltage / Current)	$\pm 3.0\%$

Display Update Rate

Response time to step input	Approx. 1 sec.
-----------------------------	----------------

Controls

User Interface	4 push buttons
----------------	----------------

Applicable Standards

EMC	IEC 61326 - 1 : 2012
Immunity	IEC 61000-4-3. 10V/m - Level 3 industrial Low level
Safety	IEC 61010-1-2010, permanently connected use
IP for water & dust	IEC 60529
Pollution degree	2
Installation Category	300V CAT III / 600V CAT II

Isolation

Protective Class	2
High Voltage Test	
1. Input + Aux vs Surface	4 kV RMS, 50Hz, 1 min
2. Input vs Remaining Circuit	3.3 kV RMS, 50Hz, 1 min

Environmental Conditions

Operating temperature	-20 to +70 °C
Storage temperature	-25 to +75 °C
Relative humidity	0 .. 95 % RH (Non condensing)
Warm up time	3 minute (minimum)
Shock (As per IEC60068-2-27)	Half sine wave, Peak acceleration 30gn (300 m/s ²), duration 18ms
Vibration	10...150...10 Hz, 0.15mm amplitude
Number of Sweep cycles	10 per axis

Interfaces

Impulse Led	For energy testing
Relay (optional)	250 VAC, 5 AAC 30V DC, 5A DC
Modbus (optional)	RS485, max.1200m Baud rate : 4.8k, 9.6k, 19.2k, 38.4k, 57.6kbps
Ethernet (optional)	Ethernet access on modbus TCP/IP Protocol

Dimensions

Bezel Size	96mm x 96mm DIN 43718
Panel cut out	92mm+0.8 X 92mm+0.8
Overall Depth	75 mm
Panel thickness	1 - 3mm for self clicking 1 - 6mm for swivel screws
Weight	320 grams Approx.

Enclosure

Enclosure front	IP 54
Enclosure back (Terminals)	IP 20

Pulse Output Option

Relay	1NO
Switching Voltage & Current	240 VAC, 5 A / 30 VDC, 5 ADC
Default Pulse rate Divisor	1 per Wh (up to 3600W), 1 per kWh (up to 3600kW), 1 per MWh (above 3600 kW up to 30000 kW)

Pulse Rate Divisors

Programmable on site

10	1 per 10Wh (up to 3600W), 1 per 10kWh (up to 3600kW), 1 per 10MWh (above 3600 kW up to 30000 kW)
100	1 per 100Wh (up to 3600W), 1 per 100kWh (up to 3600 kW), 1 per 100MWh (above 3600 kW up to 30000 kW)
1000	1 per 1000Wh (up to 3600W), 1 per 1000kWh (up to 3600kW), 1 per 1000MWh (above 3600 kW up to 30000 kW)

Pulse Duration 60ms, 100ms or 200ms

Note :

1. Refer TABLE 2 for details.
2. Above conditions are also applicable for Reactive & Apparent Energy.

Impulse Constant

Depending on nominal power, the number of impulses are created to measure the energy. The number of impulses for particular nominal power is set (as Impulse Constant) which indicates 1kWh energy. Energy can be Watt, VA or VAR. Following table shows impulses corresponding to nominal power.

Nominal power	Impulse constant
<=80	16000
<=160	8000
<=320	4000
<=640	2000
>640	1000

Note :

1) CT Sec = 1

2) For Channel Energy :

$$\text{Nominal Power} = \text{PT Sec (LL)} \times \text{CT Sec} / 1.732$$

3) For System Energy :

$$\text{Nominal Power} = 3 \times \text{PT Sec (LL)} \times \text{CT Sec} / 1.732$$

11. CT Specification

11.1 Core Balance current transformer (CBCT) for residual current measurement



Models
RISH TWE - 73/30(50)
RISH TWE - 95/50(40)
RISH TWE - 260/200(22)
RISH TWE - 135/85(30)
RISH TWE - 165/130(30)

Features
Slim Design
Encapsulated CBCT
Compact in size
Light in weight

CBCT Specifications

CBCT type	Closed toroid
Turns Ratio	600 / 1A
Rated Current	30A
System voltage	720V maximum
System Frequency	50Hz or 60 Hz
Insulation voltage	3kV for 1 minute
Distance between CBCT and Instrument	< 1 meters
Operating temperature	-10°C to +55°C

Dimensions :

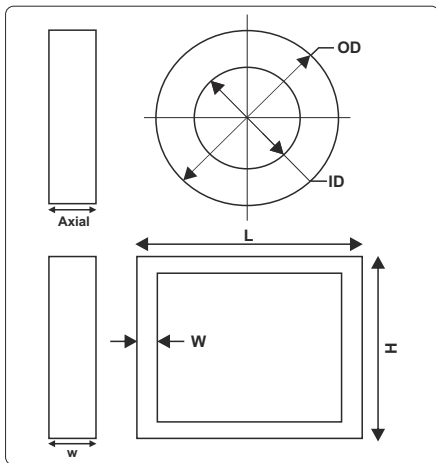

Dimensions (in mm)

CBCT	OD	ID	Axial	Current Ranges
RISH TWE - 73/30(50)	73	30	50	30mA to 30A
RISH TWE - 95/50(40)	95	50	40	30mA to 30A
RISH TWE - 135/85(30)	135	85	30	30mA to 30A
RISH TWE - 165/130(30)	165	130	30	500mA to 30A

CBCT	L	H	W	Current Ranges
RISH TWE - 260/200(22)	260	200	22	30mA to 30A

11.2 Three Phase RJ 12 CT Technical Specifications

Applicable standard	IEC 61869 - 2
Case	Polycarbonate, Flame retardant grades classified UL 94V-0
Connection	RJ 12 connection
Insulation class	E(120°C)
Maximum operating voltage(Um)	0.72kV Maximum
Test voltage	3kV, 50 Hz for 1 minute
Operating frequency	50 Hz
Rated primary rating	60A to 800A
Rated secondary output	100mA
Rated burden	0.25, 0.5 VA
Class of accuracy	0.5 or 1
Operating temperature	-25°C to +40°C
Storage temperature	-50°C to +80°C
Thermal short circuit rated current(Ith)	40 X In
Dynamic short circuit current(Idyn)	2.5 X Ith
Thermal nominal continuous rated current(Icth)	1.2 X In

11.3 Nano CT With RJ12 Specifications

Case	Polycarbonate, Flame retardant grades classified UL 94V-0
Connection	RJ 12 connection
Maximum Operating Voltage (Um)	0.72 kV Maximum
Test Voltage	3 kV, 50 Hz for 1 Minute
Operating Frequency	50 Hz/60Hz
Rated Primary Rating	63 A, 125A, 250A

Rated Secondary Output	100mA
Rated Burden	0.1 VA
Class of Accuracy	0.5
Operating Temperature	-25 ° C to +40° C
Thermal Short Circuit Rated Current (Ith)	40 X In
Dynamic Short Circuit Current (Idyn)	2.5 X Ith
Thermal Nominal Continuous Rated Current (Icth)	1.2 X In
Insulation Class	E (120°C)
Storage Temperature	-50 ° C to +80° C
Applicable Standard	IEC 61869 - 2

Note : For further details of CT, kindly refer the corresponding document.

12. QuickFix Modules

12.1 5A / 1A to 100mA QuickFix Module

The converter allows for the connections of up to three standard current transformer, or standard split-core current transformers (with 1A or 5A secondary), to the meter.

12.1.1 Specifications

Burden	0.3VA per phase (1A / 5A)
Accuracy	0.5%
Mounting	35mm DIN Rail (DIN50022)
Termination	CT to Module - Rising clamp screw terminals Module to Meter - RJ12 Patch Cable
Max Current	120% of nominal current
Output current	100mA
Operating Temperature	-20 °C to 70 °C
Storage Temperature	-25°C to 75 °C
Isolation	3000Vrms

12.1.2 Connections

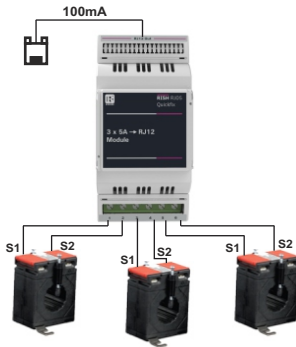

3 x Standard Current Transformers

12.1.3 Dimensions

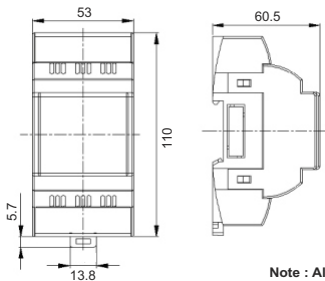

Note : All dimensions are in mm

12.2 Single Phase to Three Phase QuickFix Module

12.2.1 Connections

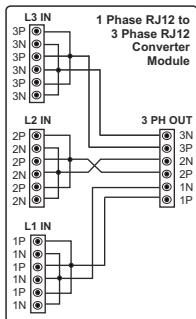
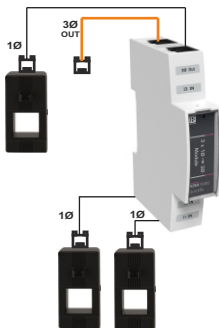

12.2.2 Dimensions

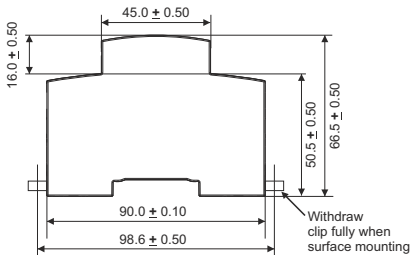

Note : All dimensions are in mm

12.3 CBCT to RJ12 QuickFix Module

12.3.1 Connections

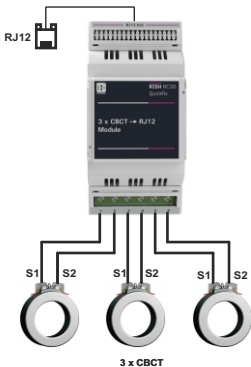

12.3.2 Dimensions

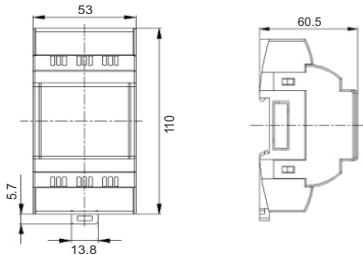

13. Meter Connection diagram with CT

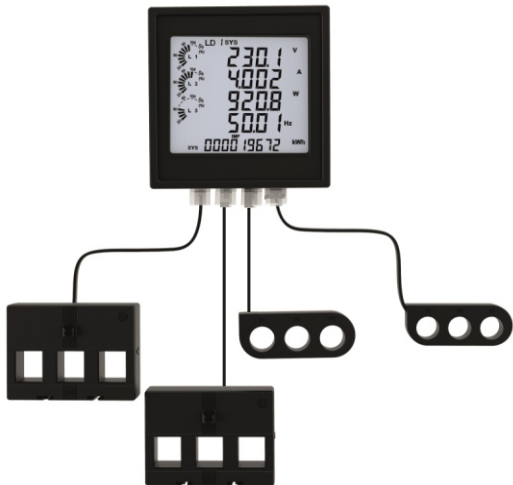

Note : The above diagram is for representation purpose only. Actual connection may depend upon the application.

14. Connection for Optional Pulse Output / RS 485 / Ethernet Module (rear (back) view of Multifunction Meter):

1. USB and RS 485 Output with 2 Relays

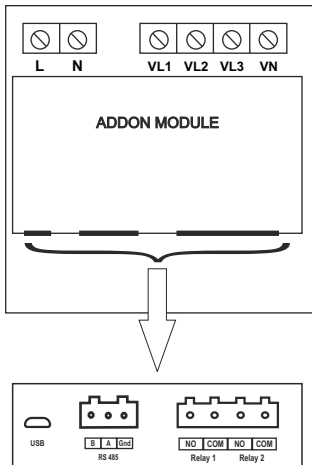

2. RS 485 Output with 2 Relays

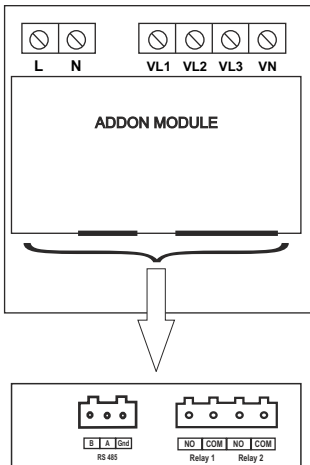

3. RS 485 Output with 4 Relays

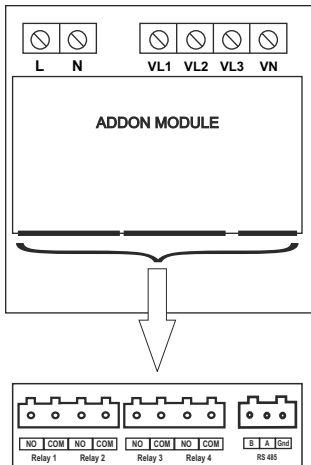

4. Ethernet Option

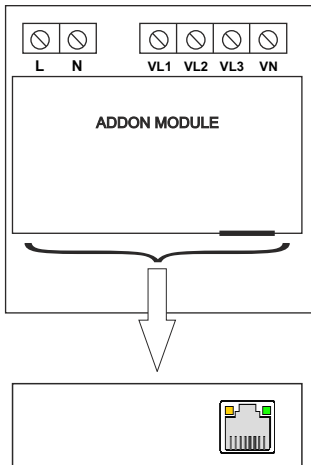

NOTE

The Information contained in these installation instructions is for use only by installers trained to make electrical power installations and is intended to describe the correct method of installation for this product. However, 'manufacturer' has no control over the field conditions which influence product installation.

It is the user's responsibility to determine the suitability of the installation method in the user's field conditions. 'manufacturer' only obligations are responsibility to determine the suitability of the installation method in the user's field conditions. 'manufacturer' only obligations are those in 'manufacturer' standard Conditions of Sale for this product and in no case will 'manufacturer' be liable for any other incidental, indirect or consequential damages arising from the use or misuse of the products.