

User Manual

RISH *Clamp* ES1000AC / ES400AC Digital Clamp meters

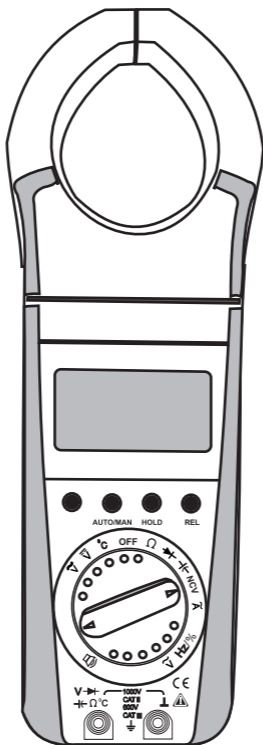

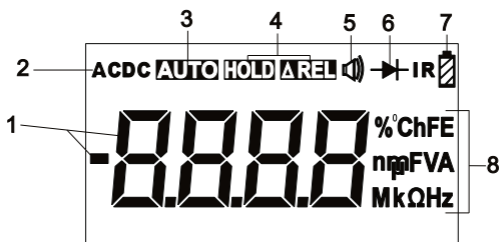
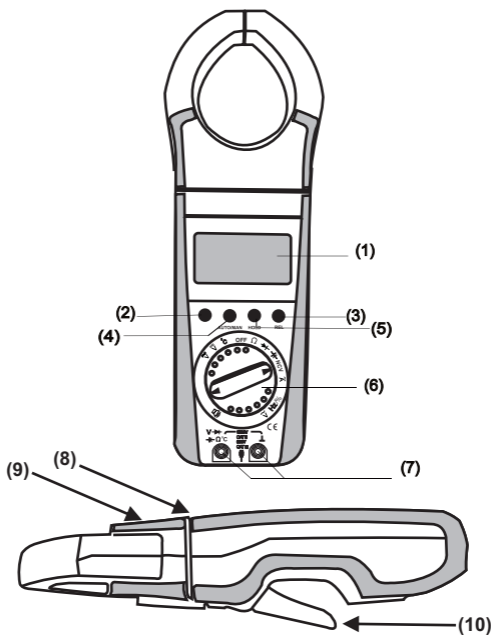

Clamp meter Operating Elements

- 1 LCD Display
- 2 Multifunction Pushbutton (yellow key)
- 3 Pushbutton for Relative value
- 4 Pushbutton for Automatic or Manual range selection
- 5 HOLD Pushbutton
- 6 Function Selector Switch for ON/OFF and Measurement Function Selection
- 7 Terminal Sockets
- 8 Limit for safe access for hand held
- 9 Rotary mechanism for clamp jaws
- 10 Safe trigger mechanism

LCD Display

- 1 Digital Display with Indication of Decimal Point and Polarity
- 2 Display of Selected Current /voltage Type
- 3 Display for Automatic Measuring Range Selection
- 4 REL, HOLD Display
- 5 Continuity Test Display: Buzzer Indication
- 6 Diode Measurement Display
- 7 Low Battery Display
- 8 Display for Unit of Measured Quantity

Contents	Page
1. Safety Features and Precautions	4
2. Initial Start-up	6
3. Selecting Measuring Functions & Ranges	7
3.1 Measuring Function Selection.....	7
3.2 Automatic Measuring Range Selection.....	8
3.3 Manual Measuring Range Selection.....	8
4. Liquid Crystal Display	9
4.1 Digital Display	9
4.2 Display with Backlit	9
5.0 Buzzer	10
6.0 Measurement Value Storage “HOLD“.....	10
7.0 REL - Relative value measurement	10
8.0 Voltage Measurement	11
9.0 Current Measurement	12
10.0 Diode Testing & Continuity Measurement	15
10.1 Diode Testing	15
10.2 Continuity Testing	16
11.0 Resistance Measurement	16
12.0 Capacitance Measurement	17
13.0 Frequency & Duty cycle Measurement	19
13.1 Frequency Measurement	19
13.2 Duty Cycle Measurement	19
14.0 Temperature Measurement	20
15.0 Non contact voltage (NCV) detection.....	20
16.0 Specifications	21
17.0 Maintenance	26
17.1 Battery	26
17.2 Housing	27
18.0 Repair and Replacement parts service	27

1 Safety Features and Precautions

You have selected an instrument which provides you with a high level of safety.

The digital clamp meter is manufactured in compliance with safety regulations. In case of incorrect use or careless handling, the safety of both user and clamp meter is not assured.



To maintain the safe and proper condition of the meters and to ensure their safe operation, it is absolutely necessary to carefully and completely read these operating instructions before using any meter. These instructions must be followed in all respects.

Observe the following safety precautions:

- The meter must only be operated by persons who understand the danger of shock hazards and know how to apply safety precautions. Shock hazards exist anywhere, where voltages of more than 30 V (TRMS) may occur.
- Do not work alone in shock hazardous environment while carrying out measurement
- *The maximum allowable voltage* between any terminal sockets (1) and earth is equal to 1000 V, with the selector switch in the voltage measurement position (selector switch in "V" position).
- Take in to account that unexpected voltages can occur at devices under test (e.g. defective devices). For example, capacitors can be dangerously charged.
- Verify that the test leads are in good condition, e.g. no cracked insulation, no open circuits in the leads or connectors.

- This meter must not be used for measurements on circuits with corona discharge (high-voltage).
- Be particularly careful when measurements are made in HF electrical circuits. Dangerous composite voltages may be present.
- Measurements under moist ambient conditions are not permitted.
- Do not exceed the *permissible overload limits of the measuring ranges*. Limit values can be found in the table "Measuring Ranges" in chapter 16 "Specifications".

Meaning of the symbols

	Warning of a danger point (Attention, refer to the user manual)
	Earth (ground) terminal.
	Double or reinforced insulation
CAT II / III / IV	Instrument for over voltage category II / III or IV
CE	EU conformity mark.

Repair, Parts Replacement and Calibration

After opening the meter, live parts may be exposed. Therefore, the meter must be disconnected from the measuring circuit prior to opening its case for repair, replacement of parts or calibration. If repair or calibration cannot be avoided unless the meter is open and live, this work must be performed by a qualified person who understands the danger involved.

Faults and Extraordinary Stress

When it must be assumed that the safe operation is no longer possible, take the meter out of service and secure it against accidental use.

It is assumed that Safe operation is no longer possible,

- when the meter shows obvious sign of damage,
- when the meter no longer functions correctly,
- after a prolonged storage under adverse conditions,
- due to severe stress due to transportation.

2 Initial Start-Up

Battery

Fit the meter with battery (batteries) provided along with the meter

Please see chapter 17.1, page 26, before initial start-up of your instrument, or after a lengthy period of storage.

Switching the Meter ON

Turn the Function selector switch from the OFF position to the desired measuring function.

All of the segments of LCD are activated briefly.

A drawing of the LCD can be found on page 1 .

**Note!**

Electrical discharge and high frequency interference can cause incorrect displays, and may block the measuring sequence. To reset, switch the meter off, and then back on. If this procedure is unsuccessful, briefly disconnect the battery from the battery compartment.

**Attention!**

Before opening the battery cover, disconnect measuring circuit and follow the instructions described in chapter 17, page 26!

Automatic turn-OFF

Your meter switches itself OFF automatically after 15 minutes, if no keys or the selector switch have been activated during this time.

Switching the Meter ON again

Press the HOLD key.

Switching the Meter OFF

Turn the selector switch to the OFF position.

3 Selecting Measuring Functions and Ranges**3.1 Measuring Function Selection**

The desired measuring function is selected with the Function selector switch (white or yellow print) . In order to select the function printed in yellow color, the yellow multifunction key must also be pressed. If the multifunction key is pressed again, the function printed in white half circle is reactivated .

3.2 Automatic Measuring Range Selection

This clamp meter features autoranging for all measuring ranges except for the range 400 mV \sim . Automatic selection is functional as soon as the meter is switched ON. According to the measured quantity applied, the meter automatically selects the measuring range which gives the best resolution.

3.3 Manual Measuring Range Selection

You can switch OFF autoranging, select and fix the ranges manually according to the table given on page no. 9.

First select the desired measuring function with the function-selector switch and, if appropriate, the multifunction key.

Briefly activate the AUTO/MAN key.

Manual mode is switched OFF if you press and hold the AUTO/MAN key until you hear a second acoustic signal, and the display switches to AUTO.

When switching back to automatic operation in the 400 mV \sim range occurs, the 4 V \sim range is activated.

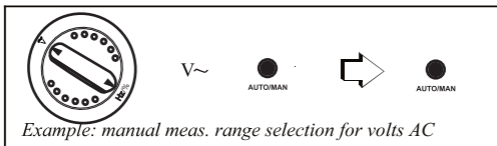

↓ AUTO/ MAN	Function	Acknowledge- ment	
		Display	Acoust. Signal
Brief	Manual Operation ON: Measuring Range is defined Switching Sequence at:		1 x
Brief	$V \overline{\text{---}}$: 400 mV → 4 V → 40 V → 400 V → 1000 V → 400 mV → 4 V → ... $V \sim /$: 4 V → 40 V → 400 V → 1000 V → 400 mV → ... $A \sim$: 40 A → 400 A → 40 A ... <small>Clamp 400 A</small> $A \sim$: 400 A → 1000 A → 400 A ... <small>Clamp 1000 A</small> Ω : 40 M Ω → 400 Ω → 4 k Ω → 40 k Ω → 400k Ω → 4 M Ω → 40 M Ω ...		1 x
Long	Return to Automatic Range Selection	AUTO	2x

Note : For Temperature ($^{\circ}C$), Frequency (Hz), Duty cycle (%) and Capacitance (F) measuring range is always Auto. No manual range selection is possible.



4 Liquid Crystal Display

4.1 Digital Display

The digital display shows the measurement value, decimal point and sign. The selected measuring unit and function are displayed. When measuring DC quantities minus sign appears in front of the digits, if the positive pole of the measurement magnitude is applied to the “ \perp ” input.

“OL” appears if the measuring range upper limit is exceeded. The digital display is updated thrice per second for V, A, Ω , Cap Freq and duty cycle measurements.

4.2 Display with Backlight

By pressing  &  keys simultaneously back light can be made ON. Back light will automatically switched off after 60 secs OR user can switch it off by pressing  & yellow key simultaneously.

5 Buzzer

The following steps are acknowledged by an sound signal:

- Activation or deactivation of the following functions:
AUTO/MAN, REL or HOLD ,Hz\%.
- When measuring AC Voltage > 750 V, DC Voltage > 1000 V, ACA > 400.0 A / ACA > 1000 A, the buzzer will keep sounding as the overload warning.
- Approximate 1 minute before the meter is auto power off, the buzzer will raise constantly 5 sounds to warning. Before the meter is power off, the buzzer will raise one long sound to warn the user.

6 Measurement Value Storage "HOLD"

By pressing the HOLD key , the currently displayed measurement value can be "held", and "HOLD" is simultaneously displayed on the LCD.

The Hold display is switched OFF if:

- the Hold key is reactivated
- the function selector switch is operated
- the yellow multi function key is activated for a change of function, e.g. AC → Hz .
- REL key is activated
- AUTO/MAN key is activated

7 REL - Relative value measurement

REL key is the key to measure relative value & it acts in activation. All functions can be used for Relative value Measurement except Hz / duty.

8 Voltage Measurement

Turn the Function selector switch to $V \rightleftharpoons$

- ⇒ Connect the measurement cable as shown. Terminal “⊥” should be grounded, and the second measuring cable with a higher potential connected to Terminal “V”.



Note!

The measuring range 400 mV \sim can only be selected manually with the “AUTO/MAN” key!

Select the respective voltage type which corresponds to the measuring value by briefly pressing the yellow multifunction key. Each activation of the key causes alternate switching between AC and DC, as well as acknowledgement by means of an sound signal. The symbols DC and AC indicate the selected voltage type in the LCD display.

After selection of this function with the selector switch, the voltage type DC is always activated

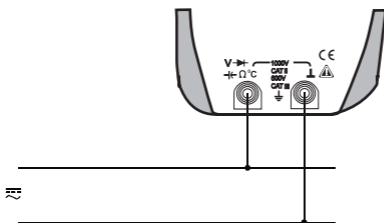

9 Current Measurement

Clamp meter 1000A can measure current upto 1000 A, in two ranges i.e. 400.0A and 1000 A. Where as Clamp meter 400A can measure current up to 400 A in two ranges i.e. 40.00A and 400.0 A. One of the two ranges can be selected manually with AUTO/MAN key. To measure the current through a cable, push the trigger(10) to open the jaws and clamp the jaws around the cable as shown in figure a and figure b.

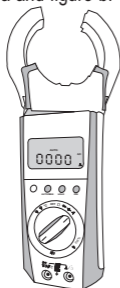

Figure a



Figure b

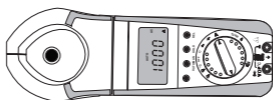

Figure c

For accurate readings keep the conductor at center position of the jaws as shown in figure c

Unique design for safety and comfort

Rotary mechanism for clamp jaws:

In conventional clamp meters display, keys and clamp jaws are in the same plane. When current measurement is to be done on vertical bus bars, over head cables, cables in congested places user connect the clamp meter but the keys and display may not be visible, hence not able to take the readings or operate the keys.

To overcome the above mentioned problem Clamp meter 400A/1000A has a unique feature called "Rotary mechanism for clamp jaws". In this, the clamp jaws are rotating. Hence it is possible to align the clamp jaws as the orientation of bus bar/conductor while keeping Display and keys facing the user, so that user can take the readings and operate the keys.

Rotary clamp jaws can be rotated at different angles with the step of 30° , maximum up to 90° in both clock-wise as well as anti-clock wise direction as shown in **figure d**.

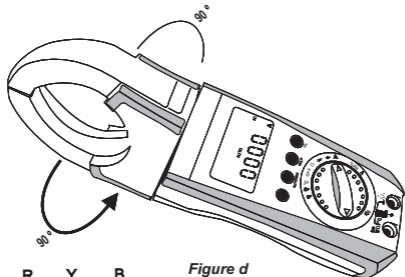

Figure d

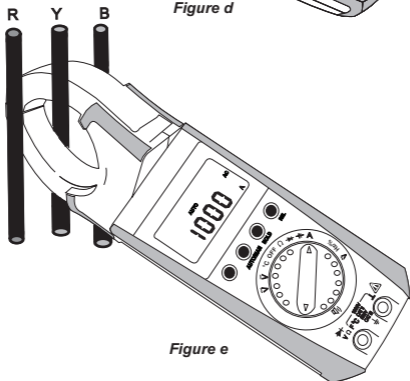

Figure e

Normally, it is difficult to access the middle busbar for current measurement. With 'Rotary mechanism for clamp jaws' it is easy to access middle bus bar, while keeping display and keys facing towards the user as shown in figure e on previous page.

Safe trigger mechanism

The conventional clamp meters have trigger mechanism either near to left jaw or right jaw. While taking measurements on bare bus bar or bare conductor the user's hand comes very close to bare bus bar/conductor, which increases the risk of electric shocks to the user.

Also in conventional clamp meters trigger is operated with single finger, usually a thumb which causes fatigue to the user while opening or closing the clamp jaws.

To overcome the above mentioned problems, Clamp meter 400A/1000A has a unique feature called 'Safe trigger mechanism' in which trigger is located at bottom side of the clamp meter and far away from the jaws and hence the bus bar.

So user's hand is at safer distance from bare conductors, hence minimizes the risk of electric shock to the user. This is shown in **figure f**.

Also trigger can be comfortably operated with more than one finger which eliminates fatigue to the user.

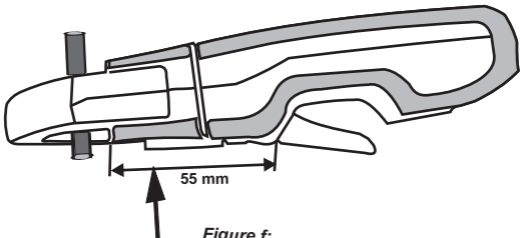

User's hand is at safer distance from bare bus bar/conductor.

10 Diode Testing & Continuity Measurement

10.1 Diode Testing



Attention!

Verify that the device under test is electrically dead. External voltages would falsify the measurement results!

- * Set the function selector switch to “ \rightarrow ”.
- * Connect the device under test as shown.

Conducting Direction and Short-Circuit

The measuring instrument displays the forward voltage in volts. As long as the voltage drop does not exceed the maximum display value of 1.000 V, you can test several elements connected in series.

Reverse Direction or Interruption

The measuring instrument displays a voltage of “OL”



Note!

Resistors and semiconductor paths in parallel to the diode distort the measurement results!

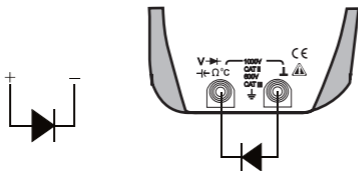

Conducting Direction

Reverse Direction

10.2 Continuity Testing



Attention!

Verify that the device under test is electrically dead.
External voltages would falsify the measurement results!

* Set the selector switch to “ \rightarrow ”.

Press the yellow multifunction key to switch to the continuity measuring range. Display of the  symbol is activated.

The instrument generates a continuous sound signal at a measured resistance of 0 ... approx. $< 75 \Omega$.

* Connect the Device Under Test as shown .

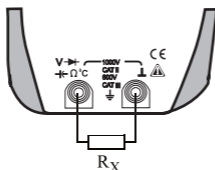

11 Resistance Measurement



Attention!

Verify that the device under test is electrically dead.
External voltages would falsify the measurement results!

* Set the selector switch to “ Ω ”.

* Connect the Device Under Test as shown.

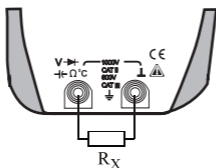

Zero Adjustment (Relative mode)

In the measurement of resistance the inherent error of the meter and the resistance of leads can be eliminated by zero adjustment.

- Short the leads connected to meter
- Press REL key

The instrument acknowledges zero adjustment with a sound signal & value close to 00 & REL are displayed on LCD.

The resistance measured at the moment the REL key is pressed serves as a reference value. This value is then automatically subtracted from all measured value.

Deleting Zero Adjustment

Short the leads connected to meter and then press REL key.

- or Activate the function selector switch.
- or Switch the Clamp meter off.

12 Capacitance Measurement



Attention!

Be absolutely certain that the device under test is electrically dead. External voltages would falsify the measurement results!

Set the function selector switch to "F".

Connect the (discharged!) device under test to socket "⊥" and "F" with measurement leads. Polarized capacitors must be connected to the "⊥" socket at the "-" pole.

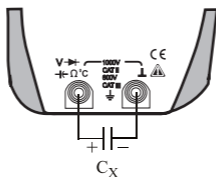

**Note!**

Resistors and semiconductor paths in parallel to the capacitor falsify the measurement results!

To measure small value capacitors please use short measurement cables!

If  is displayed the measured values are not valid.

Zero Adjustment (relative mode)

For the measurement of small capacitance values in the 5 nF and 50 nF ranges, the inherent error of the meter and the capacitance of the leads can be eliminated by zero adjustment.

-Connect the leads to the meter without Device under test.

-Briefly Press the REL key .

The instrument acknowledges zero adjustment with an sound signal, and a value close to "00.00" and REL are displayed at the LCD. The capacitance measured at the moment the key is activated serves as a reference value. This value is then automatically subtracted from all measured values.

Clearing Zero adjustment

Press REL key

clearance is acknowledged by buzzer sound.

or Activate the function selector switch

or Switch the Clamp meter off.

13.0 Frequency & Duty Cycle Measurement

13.1 Frequency Measurement

- a) Set the function selector switch to VAC and press yellow function key, as shown on page 20.
The frequency measurement mode is activated. "Hz" symbol is displayed on the LCD. The digital display is expanded to 9999 digits. Only the auto mode is possible, no manual range is possible.
- b) Connections are made the same way as for voltage measurement.
- c) The lowest measurable frequencies and the maximum allowable voltages can be found in the chapter "16.0 Specifications"

13.2 Duty Cycle Measurement

With duty cycle measurement, we can determine the ratio of pulse duration to cycle time of recurring square wave signals. The duty cycle that is the percentage pulse duration of signal is displayed on LCD i.e.

$$\text{Duty cycle (\%)} = \frac{\text{pulse duration}}{\text{cycle duration}} \times 100$$

Note : The applied frequency must remain constant during the duty cycle measurement.

- a) Set the function selector switch to VAC and press yellow function key twice as shown on page 20.
The Duty cycle (%) mode is activated. "%" symbol is displayed on LCD.
- b) Connections are made the same way as for Voltage measurement
- c) measuring range for duty cycle and maximum allowable voltage can be found in chapter "Specifications".

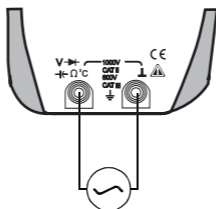
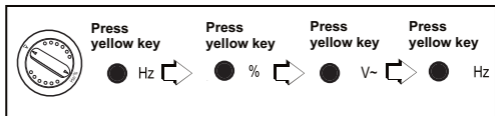

14 Temperature Measurement

Multimeter allows you to measure temperature with K-type thermocouple (NiCr-Ni) in the range 0°C to $+1300^{\circ}\text{C}$.

Set the function selector switch to “ $^{\circ}\text{C}$ ”.

Connect the sensor as shown below.

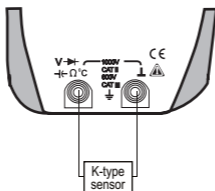

15 Non contact voltage (NCV) detection

Non contact voltage detection allows detection of AC voltage from $>75\text{V}$ 50Hz/60 Hz simply keeping the jaw of the clamp meter near the voltage carrying conductor.

Presence of voltage is indicated by the beep sound.

16 Specifications

Meas. Function	Measuring Range	Resolution	Input Impedance
			V(AC) / V(DC)
V \equiv	400.0mV	100 μ V	>20G Ω
	4.000V	1mV	11M Ω
	40.00V	10mV	10M Ω
	400.0V	100mV	10M Ω
	1000V	1V	10M Ω
V \sim	400.0mV	100mV	11M Ω
	4.000V	1mV	11M Ω
	40.00V	10mV	10M Ω
	400.0V	100mV	10M Ω
	1000V	1V	10M Ω
			Approx. Voltage drop at max. meas. current
A \sim Clamp meter 400A	40.00A	10mA	
	400.0A	100mA	
A \sim Clamp meter 1000A	400.0A	100mA	
	1000A	1A	
			Open-circuit voltage
Ω	400.0 Ω	100m Ω	approx 0.45V
	4.000k Ω	1 Ω	
	40.00k Ω	10 Ω	
	400.0k Ω	100 Ω	
	4.000M Ω	1k Ω	
	40.00M Ω	10k Ω	
\rightarrow	400.0 Ω	100m Ω	
\rightarrow	1.000V	1mV	approx 1V
F	5.000nF	1pF	
	50.00nF	10pF	
	500.0nF	100pF	
	5.000 μ F	1nF	
	50.00 μ F	10nF	
	200.0 μ F	100nF	
Hz ¹⁾			f_{min}
	10.000Hz	0.001Hz	1Hz
	100.00Hz	0.01Hz	1Hz
	1.0000kHz	0.1Hz	1Hz
	10.000kHz	1Hz	1Hz
	100.00kHz	10Hz	1Hz
	500.0kHz	100Hz	1Hz
%	2.0...98.0%	0.1%	---
			Sensor
$^{\circ}$ C	0...+1300 $^{\circ}$ C	1 $^{\circ}$ C	K-type NiCr-Ni

1) Indication for frequency measurement expanded to 9999 D

Meas. Function	Measuring Range	Digital display inherent deviation at reference conditions \pm (...% of rdg + ...digits)	Overload capacity ¹⁾	
			Overload value	Overload duration
V $\overline{=}$	400.0mV	0.75+2	1050V(DC)	Continuous
	4.000V	0.5+2		
	40.00V			
	400.0V			
	1000V			
V \sim	400.0mV	1.5+5 (> 400 digits)	1050V(AC) rms	Continuous
	4.000V	1+5		
	40.00V			
	400.0V			
	1000V	1+10		
A \sim <small>Clamp meter 400A</small>	40.00A	1.5 % of range + 5digits	480 A	Continuous
	400.0A			
A \sim <small>Clamp meter 1000A</small>	400.0A	1.5 % of range + 5digits	1100A	Continuous
	1000A			
Ω	400.0 Ω	0.8+5	500V DC/AC rms	10 min
	4.000k Ω	0.8+2		
	40.00k Ω			
	400.0k Ω			
	4.000M Ω			
	40.00M Ω	2+5		
\square)	400.0 Ω	Acoustic signal for 0...<75 Ω (approx)		
\rightarrow	1.000V	2+10		
F	5.000nF	3+40 ²⁾	500V DC/AC rms	10 min
	50.00nF	2+10 ²⁾		
	500.0nF	0.5+3		
	5.000 μ F	1+2		
	50.00 μ F	1.5+2		
	200.0 μ F	5+10 ²⁾		
Hz ⁴⁾	10.00Hz	0.2+2	\leq 1kHz : 1000V \leq 10kHz : 400V \leq 500kHz : 40V except 400mV	Continuous
	100.0Hz			
	1.000kHz			
	10.00kHz			
	100.0kHz			
	500.0kHz			
%	2.0...98.0%	10Hz...1kHz : \pm 5D 1kHz...10kHz : \pm 5D/kHz		
$^{\circ}$ C	0...+1300 $^{\circ}$ C	2+3	500V DC/AC rms	10 min

1) At 0 $^{\circ}$ C... + 40 $^{\circ}$ C

2) With zero adjustmet "REL".

3) Time required for measurement approximately 60 seconds.

4) Indication of the frequency measurement expanded to up to 9999 digits

Reference Conditions

Ambient	
Temperature	+ 23 °C ± 2 K
Relative Humidity	45% ... 55%
Measuring Magnitude	
Frequency	Sine, 50/60 Hz
Measuring Magnitude	
Waveform	Sine
Battery Voltage	3 V ± 0.1 V

Environmental conditions

Working Temperature	
Range	-10 °C ... + 50 °C
Storage Temperature	
Range	- 25 °C ... + 70 °C
Climate Classification	2z/-10/50/70/75% (without batteries) in compliance with VDI/VDE 3540
Relative Humidity	45 ... 75%
Altitude up to	2000 m

Display

LCD display field (52mm x 38mm) with digital display and display of unit of measure, current type and various special functions.

Digital

Display/Char. Height	7 segment digits / 13 mm
Number of Places	3 3/4 place \triangleq 3999 steps
Overflow Display	" OL "
Polarity Display	" - " sign is displayed when plus pole is at " \perp "
Measuring Rate	3 measurements/s

Influence Quantity and Effects

Influence Variable	Influence Range	Meas. Magnitude/ Measuring Range	Influence Effect
Temperature	0 °C ... +21 °C and +25 °C ... +50 °C	V $\overline{\text{---}}$	0.1 x intrinsic error/K
		V \sim	
		A \sim	
		Ω	
		F	
		Hz	
		Duty(%)	
°C			

Influence Variable	Influence Range (max. resolution)	Frequency	Intrinsic Error at Ref. $\pm(\dots \% \text{ of rdg. } + \dots D)$
Frequency V_{AC}	4, 40, 400V	20 Hz ... <50 Hz >60 Hz ... 1kHz	2 + 3
	400mV, 1000V	20 Hz ... <50 Hz >60 Hz ... 500 Hz	2 + 3

Influence Variable	Influence Range	Meas. Magnitude/ Measuring Range	Influence Effect
Relative Humidity	55 ... 75%	V \approx A \sim Ω , F, Hz, (%), °C	1x intrinsic error

AUX. Voltage influence:

(without  display) - all ranges except cap.: $\pm 8 D$

cap.range: $\pm 60 D$ at battery voltage 2.6V

Power Supply

Battery	1.5 X 2 (AAA Size) zinc-carbon cell OR alkaline manganese cell per IEC 6LR 03
Service Life	with zinc-carbon cell: approx. 200 hr. with alkaline manganese cell: approx. 400 hr.
Battery Test	Automatic display of the symbol “  ” when battery voltage falls to level 2.65V to 2.35V (Can vary from meter to meter)

Electromagnetic compatibility (EMC)

EMC immunity:	IEC 61326-1:2012, Table A.1 IEC 61000-4-2 8KV atmosphere discharge. 4KV contact discharge. IEC 61000-4-3 3V/m
---------------	--

Note: Short-term measured value deviation may occur during electro-magnetic interference thus reducing the specified operating quality.

Electrical Safety	IEC 61010-1-2010
Installation category	600V CAT III / 1000V CAT II
Pollution degree	2
High voltage test	~ 4.4kV 50 Hz for 1min between housing and input terminals

Mechanical Design

Protection	For meter : IP 52 For Terminals : IP 20
Dimensions	90 mm (W) x 270mm (L) x 70mm (H)
Weight	approx. 0.600 kg with battery

17.0 Maintenance

Attention:

Disconnect the instrument from the measuring circuit before opening the instrument to replace the battery

17.1 Battery

Before initial start-up, or after storage of your instrument, make sure that no leakage has occurred at the instrument battery. Repeat this inspection at regular intervals.

If battery leakage has occurred, electrolyte from the battery must be carefully and completely removed and a new battery must be installed, before the instrument can be placed back into operation.

If the "" symbol appears in the LCD display, you should change the battery as soon as possible. You can continue to take measurements, but reduced measuring accuracy may result.

Replacing the Battery(ies)

Simply unscrew the battery compartment cover from base housing. No need to remove whole housing.

Remove the battery from the battery compartment. Insert two new 1.5 V AAA (Size) cells in accordance with the polarity symbols in the battery compartment.

Screw the battery compartment cover to base housing. Dispose of the dead battery in an environmentally sound fashion.

17.2 Housing

No special maintenance is required for the housing. Excessive contamination has an adverse effect on isolation and reduces input resistance. The surface must be kept clean for this reason. Use a slightly dampened cloth for cleaning. Avoid the use of cleansers, abrasives or solvents.

18.0 Repair and Replacement parts service

When you need service, Please refer contact details on last page.

WARRANTY

Dear Customer,

You are now the privileged owner of Digital Clamp meter / Accessories, a product that ranks the first of its kind in the world.

Company provides 12 months warranty from the original date of purchase against defective material and workmanship.

In the unlikely event of failure of this meter / accessories within the warranty period, Company will repair the meter / accessories free of charges. Please hand over the meter / accessories to the dealer / Stockiest from whom you have purchased along with this card and relevant cash memo / Invoice. This warranty entitles you to bring the meter / accessories at your cost to the nearest stockiest / dealer and collect it after repairs.

NO TRANSPORTATION CHARGES WILL BE REIMBURSED

The warranty is not valid in following cases:

- 1) Warranty card duly signed / stamped and original cash memo / invoice are not sent along with the meter / accessories.
- 2) Complete warranty card is not presented to authorised person at the time of repairs.
- 3) Meter / accessories not used as per the instruction in the user manual.
- 4) Defect caused by misuse, negligence, accidents, tampering and acts of god.
- 5) Improper repairing by any person not authorised by the company.
- 6) Any sort of modification, alteration is made in electrical circuitry.
- 7) Seal provided inside is broken.

Warranty of Digital Clamp meter / Accessories does not cover fuses and battery. In case of dispute to the validity of warranty, the decision of Company's service center will be final.

If you bought this meter / accessories directly from the company, and if you notice transit Damage, then you must obtain the insurance surveyors report and forward it to Company. Thank you.

(To be filled by authorized dealer)

Model No. : _____

Serial Number : _____

Date of Purchase : _____

Cash Memo / Invoice No. : _____

Dealer's Signature : _____

Dealer's Stamp : _____

Scope of Supply:

- 1) Meter
- 3) Battery
- 5) Warranty Card

- 2) Cable set
- 4) User Manual
- 6) Test Certificate



RISHABH INSTRUMENTS PVT. LTD.

Factory: F-31, MIDC, Satpur, Nashik-422 007 India

Phone(0253) 2202202, 2202162

Fax : 91 - 0253 - 2351064, 2202302

E-mail : International: exp.marketing@rishabh.co.in

India: marketing@rishabh.co.in

www.rishabh.co.in

Printed in India, Subject to change without Notice